

# SPD Pedals Light Action



User's manuals in other languages are available at :  
<http://si.shimano.com>

## IMPORTANT NOTICE

- Contact the place of purchase or a bicycle dealer for information on installation and adjustment of the products which are not found in the user's manual. A dealer's manual for professional and experienced bicycle mechanics is available on our website (<http://si.shimano.com>).
- Do not disassemble or alter this product.

**For safety, be sure to read this user's manual thoroughly before use, and follow it for correct use.**

## Important Safety Information

**For replacement information, contact the place of purchase or a bicycle dealer.**

### WARNING TO PARENT / GUARDIAN

- USE OF THIS PRODUCT IN ACCORDANCE WITH THESE USER'S MANUALS IS ESSENTIAL FOR YOUR CHILD'S SAFETY. MAKE SURE YOU AND YOUR CHILD UNDERSTAND THESE USER'S MANUALS. FAILURE TO FOLLOW THESE USER'S MANUALS MAY RESULT IN SERIOUS PERSONAL INJURY.**

### WARNING

- These pedals are designed for recreation. These pedals can be engaged with and released from the cleats more easily than SPD pedals. These pedals are designed for non competition and non aggressive uses. If they are used aggressively the cleats may become accidentally released from the pedals and you may fall off the bicycle.
- These pedals are designed so that you release them only when intended. They are not designed to release automatically at times such as when falling off the bicycle.
- Use only SPD shoes with this product. Other types of shoes may not release from the pedals, or may release unexpectedly.
- Use only Shimano cleats (SM-SH51 / SM-SH56) and tighten the mounting bolts securely to the shoes.
- Before attempting to ride with these pedals and shoes, make sure you understand the operation of the engagement / release mechanism for the pedals and cleats (shoes).
- Before you attempt to ride with these pedals and shoes, apply the brakes, then place one foot on the ground and practice engaging and releasing each shoe from its pedal until you can do so naturally and with minimal effort.
- Ride on level ground first until you become accustomed to engaging and releasing your shoes from the pedals.
- Before riding, adjust the spring tension of the pedals to your liking. If the spring tension of the pedals is low, the cleats may become accidentally released and you may lose balance and fall off the bicycle. If the spring tension of the pedals is high, the cleats cannot be easily released.
- When riding at low speed or when there is a possibility that you might need to stop riding, (for example, when doing a U-turn, nearing an intersection, riding uphill or turning a blind curve), release your shoes from the pedal beforehand so that you can quickly put your feet onto the ground at any time.
- Use a lighter spring tension for attaching the pedal cleats when riding in adverse conditions.
- Keep cleats and bindings out of dirt and debris to ensure proper engagement and release.
- Remember to check the cleats periodically for wear. When the cleats are worn, replace them. Always check the spring tension before riding and after replacing the pedal cleats.

**BE SURE TO READ AND FOLLOW THE ABOVE WARNINGS CAREFULLY.**  
If the warnings are not followed, your shoes may not come out of the pedals when you intend or they may come out unexpectedly or accidentally, and severe injury may result.

- Reflectors have to be mounted to the bike at any time as soon as traveling on public roads.
- Optional reflectors are available for models that do not come equipped with reflectors as standard. For information on suitable reflectors, contact the place of purchase or a bicycle dealer.

- Do not continue riding the bicycle if the reflectors are dirty or damaged, otherwise it becomes more difficult for oncoming vehicles to see you.
- After reading the user's manual carefully, keep it in a safe place for later reference.

## Note

- In addition, if pedaling performance does not feel normal, check this once more.
- If you experience any trouble with the rotating parts of the pedal, the pedal may require adjustment. Contact the place of purchase or a bicycle dealer.
- Parts are not guaranteed to resist natural wear or deterioration resulting from normal use.
- For maximum performance we highly recommend Shimano lubricants and maintenance products.

## Regular inspections before riding the bicycle

Before riding the bicycle, check the following items. If any problems are found with the following items, contact the place of purchase or a bicycle dealer.

- Are the fastening sections fixed securely?
- Is there a large play between the cleats and the pedals because of wear?
- Are there any abnormalities in the engagement and release of the cleats?
- Are there any abnormal noises?

## Names of parts

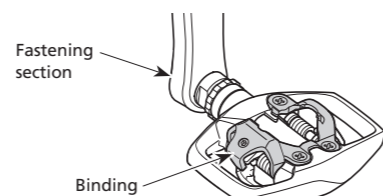

## Cleat types and using the pedals

### WARNING

Do not use the pedals and cleats in any way other than as described in these user's manuals. The cleats are designed to engage and release from the pedals when facing forward.

See below for instructions on how to install the cleats.  
**FAILURE TO FOLLOW THESE INSTRUCTIONS MAY RESULT IN SERIOUS PERSONAL INJURY.**

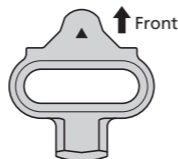

Single release mode cleats (SM-SH51) and multiple release mode cleats (SM-SH56) are available for use with these pedals.

Each type of cleat has its own distinctive features, so be sure to read the Service Instructions carefully and select whichever type of cleat best suits your riding style and the terrain and riding conditions which you will encounter.

Other types of cleats, such as single release mode cleats (SM-SH52) and multiple release mode cleats (SM-SH55), cannot be used as they do not provide stable enough step-out performance or sufficient holding force.

## Engaging the cleats with the pedals

Press the cleats into the pedals with a forward and downward motion.

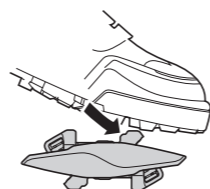

## Releasing the cleats from the pedals

The method of release varies according to the type of cleats you are using. (Check the model number and color of your cleats to determine the proper method of release.)

Multiple release mode cleats: SM-SH56 (silver, gold)	Single release mode cleats: SM-SH51 (black / Optional accessory)
The cleats can be released by twisting your heel in any direction.	These cleats only release when the heel is moved <b>outward</b> . They will not release if the heel is twisted in any other direction.
Because the cleats can also be released by lifting your heel, they may become accidentally released when applying upward force on the pedals. These cleats should not be used for riding which involves pulling up on the pedals, or for activities such as jumping, in which pulling force is applied to the pedals causing possible release.	Upward force may be applied to the pedal, since they will not release unless the foot is twisted outward.
Although the cleats can be released by twisting your heels in any direction, or by lifting, they will not necessarily release if you lose your balance. Accordingly, for places and conditions where it looks as though you may lose balance, make sure that you have sufficient time to release the cleats beforehand.	The cleats will not necessarily release if you lose your balance. Accordingly, for places and conditions where it looks as though you may lose balance, make sure that you have sufficient time to release the cleats beforehand.
If the cleats release by accident, you may fall off the bicycle and serious injury may result. If the use of the multiple release mode cleats are not sufficiently understood or used correctly, they may release accidentally more frequently than single release mode cleats. You can help to prevent this by adjusting the amount of force required to release the cleats in any direction, and you should practice until you are accustomed to the amount of force and the angle required to release.	When you are pedaling vigorously, your heel may inadvertently twist outward and this may cause the cleat to release accidentally. If the cleat releases by accident, you may fall off the bicycle and serious injury may result. This can be prevented by adjusting the amount of force required to release the cleats; you should practice until you are accustomed to the amount of force and the angle required to release the cleats.

### Note:

It is necessary to practice releasing until you become accustomed to the technique.

- \* In multiple release mode, releasing by lifting your heel requires particular practice.

## Adjusting the spring tension of the pedals

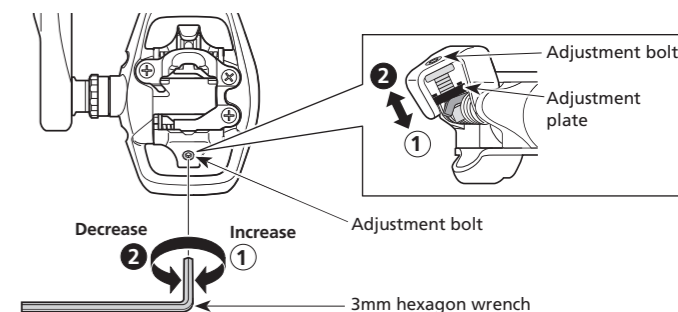

- The spring tension of the pedals can be adjusted by turning the adjustment bolts to adjust the spring force of the binding.
- Clicking the adjustment bolt changes the tension one step. There are four clicks per turn.
- The adjustment bolt is located at the rear of each binding, resulting in four positions in total. (Some models have a total of two adjustment bolts counting both pedals.)
- Adjust the spring force to the optimal cleat holding force when releasing the cleats from the bindings.
- Equalize the cleat holding forces at four positions (two positions for some models) by checking the adjustment plate position and counting the number of turns of the adjustment bolts.
- Turning the adjustment bolt clockwise increases the spring tension, and turning it counterclockwise decreases it.

### Strongest position

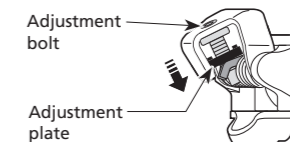

### Weakest position

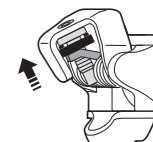

If the adjustment plate is at the strongest or the weakest position, do not turn the adjustment bolt any further.

### Note:

- In order to prevent accidental or unintentional release from occurring, make sure all the spring tensions are properly adjusted and check the spring tensions.
- If the spring tensions are not adjusted equally, it can cause the rider difficulty to engage or release from the pedals. The spring tension should be adjusted equally for both the right and left pedal.

## Replacement of the cleats and body cover

The cleats and body cover are consumables and need to be replaced periodically. The cleats and body cover should be replaced at a dealer or an agency as soon as possible after they become worn and difficult to release or can be released with much less effort than that required when they were new.

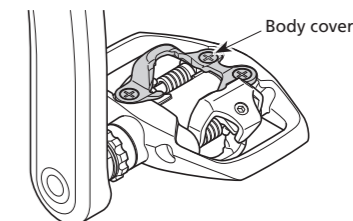

# SHIMANO

SHIMANO NORTH AMERICA BICYCLE, INC.  
One Holland, Irvine, California 92618, U.S.A. Phone: +1-949-951-5003

SHIMANO EUROPE B.V.  
High Tech Campus 92, 5656 AG Eindhoven, The Netherlands Phone: +31-402-612222

SHIMANO INC.  
3-77 Oimatsu-cho, Sakai-ku, Sakai-shi, Osaka 590-8577, Japan

Please note: specifications are subject to change for improvement without notice. (English)  
© May 2018 by Shimano Inc. ITP