

**General Safety Information**

**WARNING**

- To avoid serious injuries:
- Obtain and read the service instructions carefully prior to installing the parts. Loose, worn, or damaged parts may cause serious injury to the rider. We strongly recommend only using genuine Shimano replacement parts.
- Read these Technical Service Instructions carefully, and keep them in a safe place for later reference.

**CAUTION**

- To avoid serious injuries:
- Reduce the force being applied to the pedals when shifting the lever. If you try to force operation of the shifting lever while the pedals are being turned strongly, your feet may come off the pedals and the bicycle may topple over, which could result in serious injury.

**NOTE:**

- The CJ-S700 cassette joint should only be used with sprockets from 18T to 23T. If using the CT-S500 chain tensioner, use the special CS-S500 18T or 20T sprocket with chain guard. Do not use any other type of sprocket; otherwise, the chain may come off the sprocket.
- When lubricating the chain or the sprockets, be careful not to get any oil on the rubber bellows or the rubber cover of the cassette joint.
- For maximum performance we highly recommend Shimano lubricants and maintenance products.
- Parts are not guaranteed against natural wear or deterioration resulting from normal use.

**To shift to higher gear (Lever B)**

You can vary the lever stroke to shift the desired number of gears, so that to shift by one gear only, move the lever to the (1) position, and to shift by two gears at one time, move the lever to the (2) position. A maximum two-gear shift can be made in this manner.

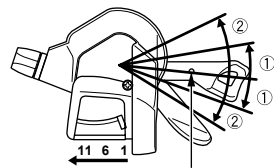

**Installation of the shifting lever**

Install the shifting lever as shown in the illustration.  
Use a handlebar grip with a maximum outer diameter of 34 mm.

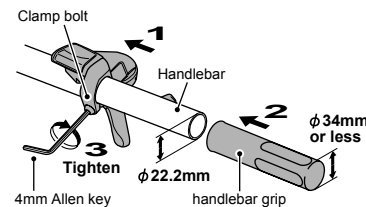

**Tightening torque:**  
4.5 – 6.5 N·m {39 – 57 in. lbs.}

**Replacement and assembly of the indicator unit**

Disassembly and assembly should only be carried out when removing and replacing the indicator unit.

**Removal**

1. Operate lever B 10 times or more to set it to [1].
2. Loosen and remove the 3 cover fixing screws which are securing the indicator unit.
3. Remove the indicator unit as shown in the illustration.

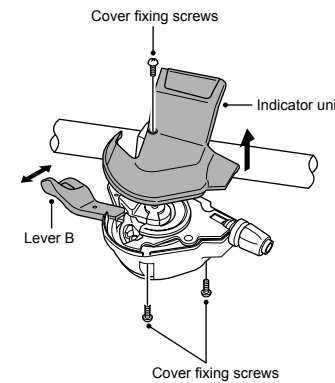

**Installation**

4. Check that the needle of the indicator is on the left side ([1] position), and then install the indicator unit so that it is facing straight upward. At this time, check that the main axle is installed in the cam unit hole and that the pin of the cam unit is installed in the winder unit hole, and then insert the indicator shaft protruding from the bottom of the indicator unit into the groove of the cam unit.

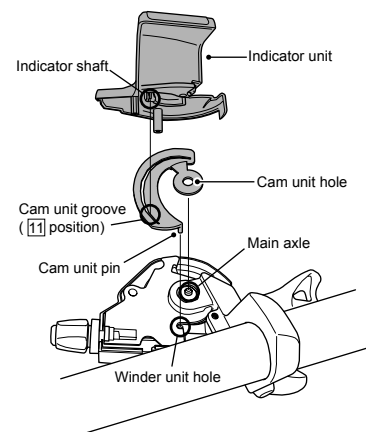

5. Secure the indicator unit with the 3 cover fixing screws.

**Tightening torque:**  
0.3 – 0.5 N·m {3 – 4 in. lbs.}

6. Operate lever A and lever B, and check their operation. If they do not operate correctly, reinstall the indicator unit while taking particular note of step 4, above.

Do not disassemble the indicator unit or the shifting lever unit. Disassembling them may result in malfunctions.

**Disconnecting the shifting cable when removing the rear wheel from the frame**

Disconnect the cable from the cassette joint when removing the rear wheel from the frame.

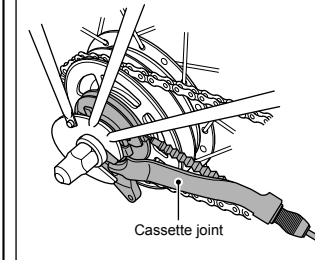

1. Set the shifting lever to [1].

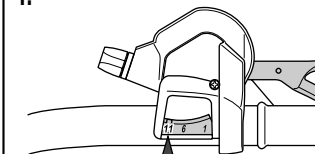

2. Press the lever of the pulley clockwise to loosen the inner cable. In the following steps 3 and 4, continue to work in this condition.

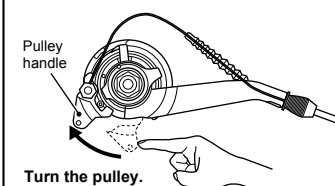

3. Pull the outer casing holder out of the outer casing holder holding section of the cassette joint. Remove the inner cable with the rubber bellows from the slit of the bracket. At this time, be careful that the rubber bellows are not scratched.

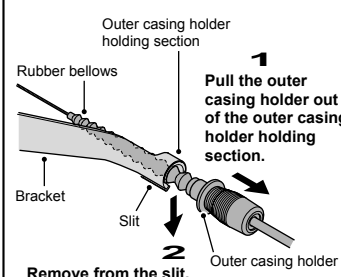

4. Remove the inner cable fixing bolt unit from the cassette joint pulley.

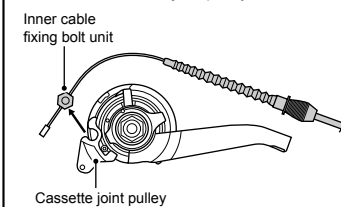

**Note:**  
If reusing the cable, refer to steps 9 to 12 in "Installation of the shifting cable".

**Installation of the shifting cable**

Use a shifting cable with one inner cable drum. Cable with one inner cable drum: OT-SP41/SP40 (4 mm dia.)

1. Set the shifting lever to [1].

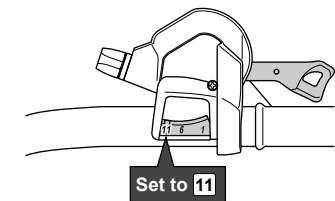

**Shifting lever side**

2. Loosen and remove the wire end hooking cap.

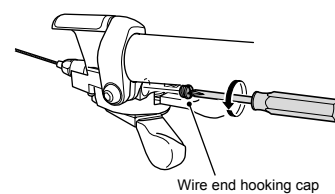

3. Insert the inner cable into the hole in the winder unit, and then pass it through the hole in the cable adjustment bolt. Next, pull the inner cable so that the inner cable drum fits into the notch in the winder unit.

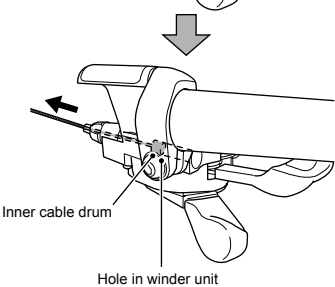
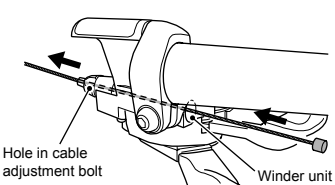

4. Screw in the wire end hooking cap as shown in the illustration until it stops. If it is turned any further, it will damage the screw thread in the cover. In addition, the unit cover may become bent, which may cause an obstruction between the unit cover and lever A, and lever A may not operate correctly. If lever A does not return properly, loosen the wire end hooking cap slightly to make a gap between lever A and the unit cover, and check that this improves the returning of lever A.

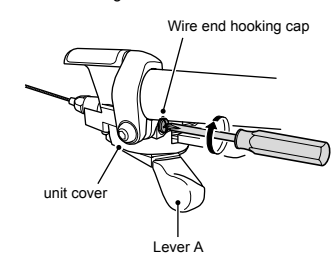

**Tightening torque:**  
0.3 – 0.5 N·m {3 – 4 in. lbs.}

5. Pass the inner cable through the OT-SP41/SP40 outer casing through the end with the plastic cap.

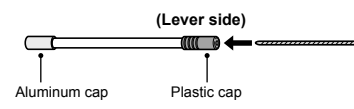

If cutting the outer casing, cut it near the end with the plastic cap while the cap is still attached. Then make the cut end perfectly round and attach the plastic cap.

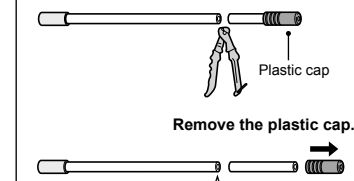

**Make the cut end perfectly round.**

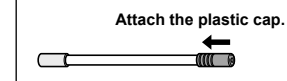

**Cassette joint side**

6. Install the rubber cover and rubber bellows to the outer casing holder.

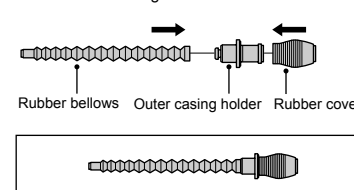

7. Wipe away any grease which may be on the inner cable, and then pass the inner cable through the rubber bellows. After this, insert the outer casing into the rubber cover and set it into the outer casing holder.

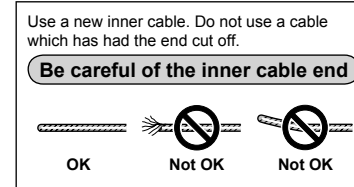

- 1) While holding the end of the rubber bellows, insert the inner cable. Be careful not to pierce the rubber bellows with the end of the inner cable at this time.

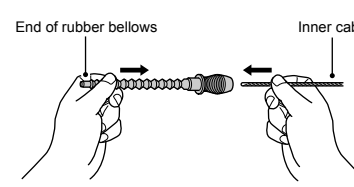

- 2) Slide the rubber bellows onto the inner cable.

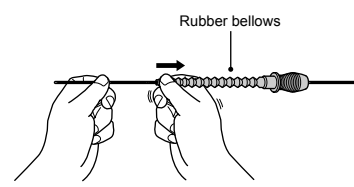

- 3) Push the outer casing on so that it securely touches the outer casing holder.

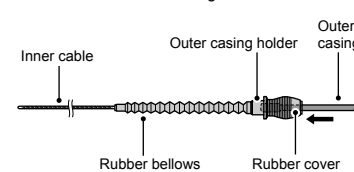

8. After checking that the end of the outer casing is sitting securely in the cable adjustment bolt of the shifting lever, attach the inner cable fixing bolt unit to the inner cable. It is recommended that the special tool TL-S700 is used when attaching the inner cable fixing bolt unit.

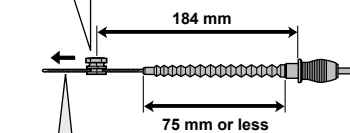
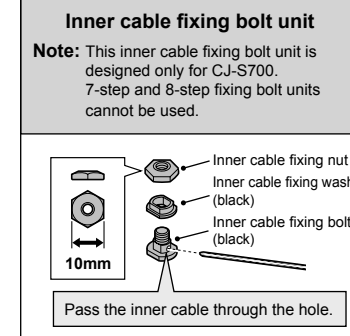

Pull the inner cable while attaching the inner cable fixing bolt unit.

**Tightening torque:**  
3.5 – 5.5 N·m {30 – 48 in. lbs.}

9. Turn the lever of the pulley clockwise. In the following steps 10 and 12, continue to work in this condition.

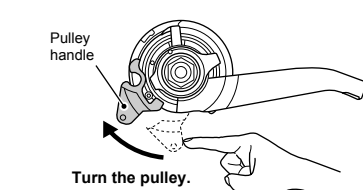

10. Bring the cable around to the cassette joint pulley, hold it so that the inner cable fixing nut is facing to the outside (toward the frame end), and then slide the flat part of the inner cable fixing washer into the gap in the pulley.

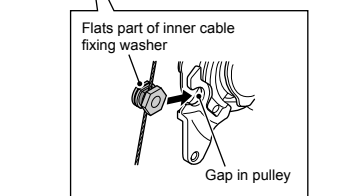
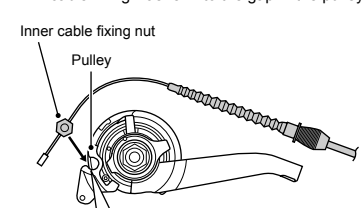

11. Turn the cable 60° clockwise and attach it to the hook.

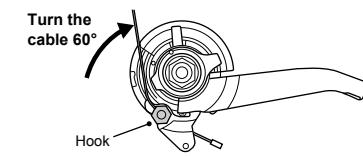

12. Attach the inner cable to the pulley as shown in the illustration, pass the part of the inner cable which has the rubber bellows attached through the slit in the cassette joint bracket, and then insert the outer casing holder securely into the outer casing holder holding section. Be careful not to damage the rubber bellows at this time.

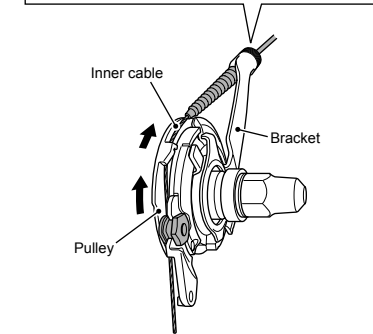
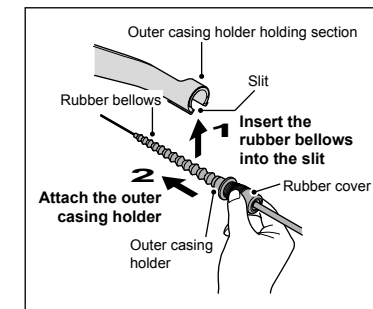

**Note:**  
Check that the inner cable is correctly seated inside the pulley guide.

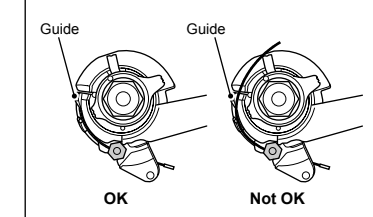

13. Secure the cable to the frame with the outer casing bands.

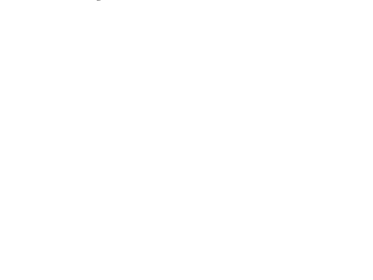
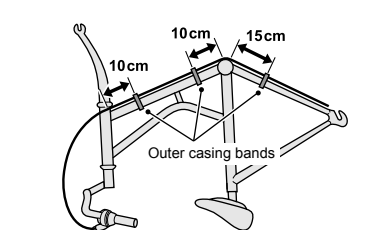

These service instructions explain how to use and maintain the Shimano bicycle parts which have been used on your new bicycle. For any questions regarding your bicycle or other matters which are not related to Shimano parts please contact the place of purchase or the bicycle manufacturer.

\* Service Instructions in further languages are available at: <http://techdocs.shimano.com>

Please note: specifications are subject to change for improvement without notice. (English)

**SHIMANO**

SHIMANO AMERICAN CORPORATION  
One Holland, Irvine, California 92618, U.S.A. Phone: +1-949-951-5003

SHIMANO EUROPE B.V.  
Industrieweg 24, 8071 CT Nunspeet, The Netherlands Phone: +31-341-272222

SHIMANO INC.  
3-77 Oimatsu-cho, Sakai-ku, Sakai-shi, Osaka 590-8577, Japan

**Adjusting the cassette joint**

1. Set the shifting lever from [1] to [6]. Check to be sure that the yellow setting lines on the cassette joint bracket and pulley are aligned at this time.

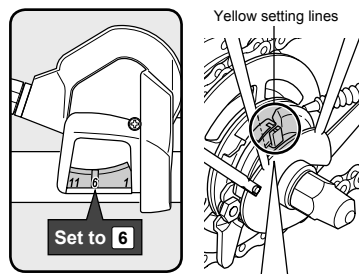

The yellow setting lines on the cassette joint are located in two places. Use the one that is easiest to see.

**When bicycle is standing up**

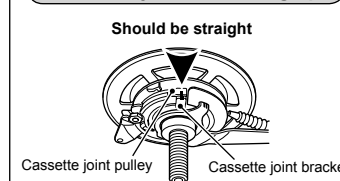

**When bicycle is upside down**

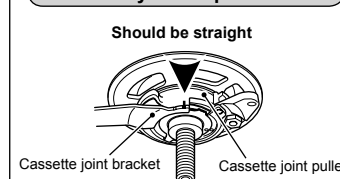

If the yellow setting lines are not aligned, turn the cable adjustment bolt of the shifting lever to align the yellow setting lines. After this, move the shifting lever once more from [6] to [1] and then back to [6], and then re-check to be sure that the yellow setting lines are aligned.

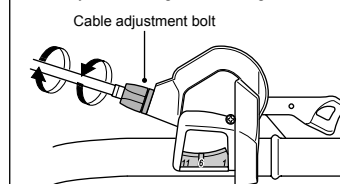

2. After adjusting the cassette joint, cut off the excess length of inner cable and then install the inner end cap. After attaching the inner end cap, bend the inner cable outward (toward the frame end) to prevent it from coming in contact with the chain.

