

**WARNING**

- Be careful not to let the cuffs of your clothes get caught in the chain while riding, otherwise you may fall off the bicycle.
- Obtain and read the service instructions carefully prior to installing the parts. Loose, worn or damaged parts may cause the bicycle to fall over and serious injury may occur as a result. We strongly recommend only using genuine Shimano replacement parts.
- Obtain and read the service instructions carefully prior to installing the parts. If adjustments are not carried out correctly, the chain may come off and this may cause you to fall off the bicycle which could result in serious injury.
- Read these Technical Service Instructions carefully, and keep them in a safe place for later reference.

**Note**

- The front derailleur is for double front chainwheels only. It cannot be used with triple front chainwheels, as the shifting points will not match.
- If gear shifting operations do not feel smooth, wash the derailleur and lubricate all moving parts.
- If the amount of looseness in the links is so great that adjustment is not possible, you should replace the derailleur.
- When the chain is in the position shown in the illustration, the chain may contact the front chainrings or front derailleur and generate noise. If the noise is a problem, shift the chain onto the next-larger rear sprocket or the one after.
- For frames with suspension, the chain stay angle will vary depending on whether the bicycle is being ridden or not being ridden. When the bicycle is not being ridden and the chain is positioned on the largest/larger chainring and on the smallest sprocket, the chain guide outer plate of the front derailleur may touch the chain.
- Shimano does not provide the bottom bracket mount fixing bolts.
- For smooth operation, use the specified outer casing and the bottom bracket cable guide.
- Parts are not guaranteed against natural wear or deterioration resulting from normal use.
- For maximum performance we highly recommend Shimano lubricants and maintenance products.
- For any questions regarding methods of installation, adjustment, maintenance or operation, please contact a professional bicycle dealer.
- Be sure to read the service instructions for the Front Drive System in conjunction with these service instructions.

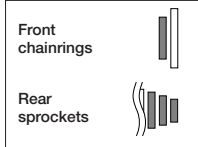

Technical Service Instructions

SI-5MY0A-001

**FD-M785 / FD-M785-E2  
FD-M786 / FD-M786-D**

Front derailleur

Specifications

X = Available

Model number	FD-M785	FD-M785-E2	FD-M786	FD-M786-D
Normal type	X	X	X	X
Top route type	X	X	X	X
Front chainwheel tooth difference	14T	12T	14T	14T
Front derailleur installation band diameter	S, M, L	-	S, M, L	-
Chainstay angle (α)	66° - 69°	66° - 69°	66° - 69°	66° - 69°
Applicable chain line	48.8 mm	44-38T	40-38T	44-38T
Applicable front chainwheel	For double chainwheel only FC-M785 (38-26T / 40-28T)			

Installation of the front derailleur

**For bracket type**

Install as shown in the illustration.

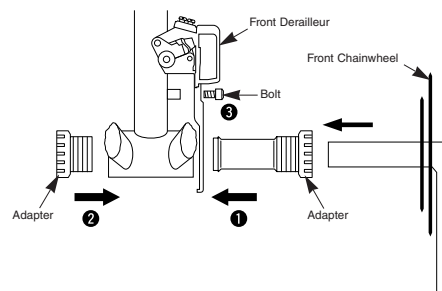

1, 2 Tightening torque :  
35 - 50 N·m {305 - 435 in. lbs.}

3 Tightening torque :  
5 - 7 N·m {44 - 60 in. lbs.}

**Note:**

When installing the components to carbon frame/handle bar surfaces, verify with the manufacturer of the carbon frame/parts for their recommendation on tightening torque in order to prevent over tightening that can cause damage to the carbon material and/or under tightening that can cause lack of fixing strength for the components.

• FD-M785 / M786

Install the front derailleur as shown in the illustration. At this time, adjust the position of the front derailleur while installing it so that there is a clearance of 1 - 3 mm between the chain guide outer plate and the maximum outer diameter of the larger chainring.

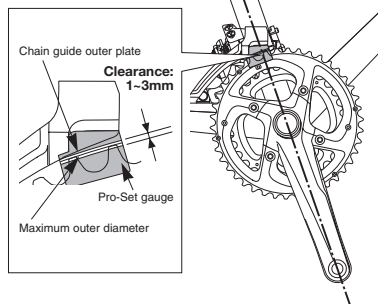

Set the height of the front derailleur. The flat section of the chain guide outer plate should be directly above and parallel to the larger chainring. Secure using a 5 mm allen key.

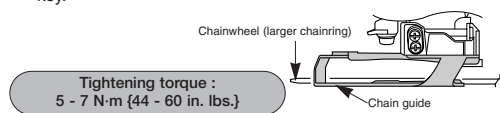

Tightening torque :  
5 - 7 N·m {44 - 60 in. lbs.}

• FD-M786-D

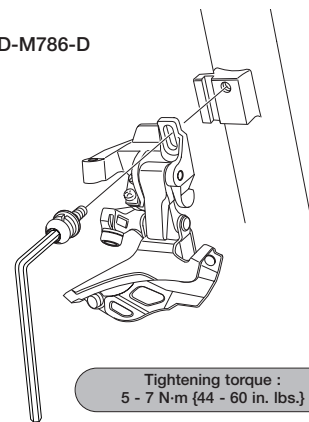

Tightening torque :  
5 - 7 N·m {44 - 60 in. lbs.}

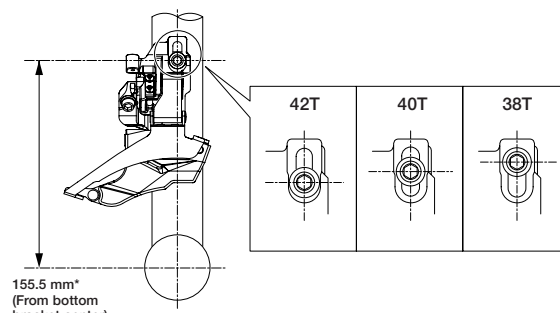

155.5 mm\*  
(From bottom bracket center)

\* The installation height will vary depending on the position of the frame washer.

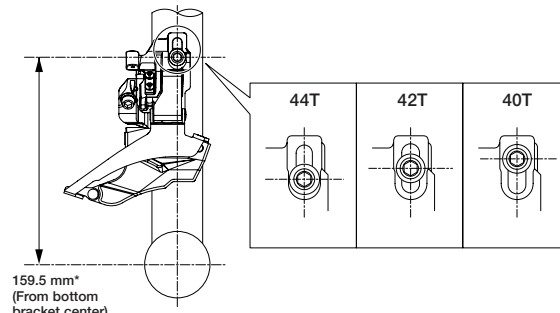

159.5 mm\*  
(From bottom bracket center)

• FD-M785-E2

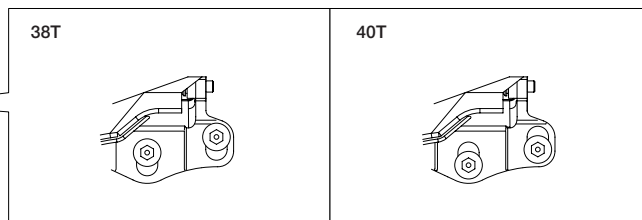
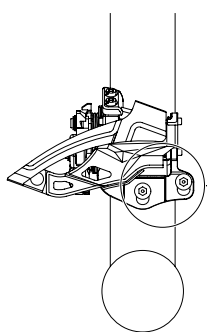

Models without BB plate

• FD-M785-E2

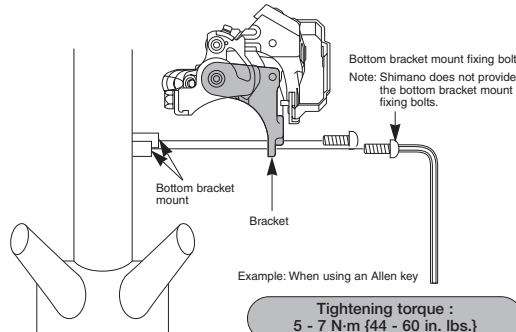

Tightening torque :  
5 - 7 N·m {44 - 60 in. lbs.}

SIS Adjustment

Be sure to follow the sequence described below.

\* If the bicycle has rear suspension, first check the recommended segment position according to the owner's manual for the rear suspension. Next, use a fixing band or similar to set the rear suspension to the recommended stroke for the rear suspension, and then adjust the front derailleur.

1. Low adjustment

Set so that the clearance between the chain guide inner plate and the chain is 0 - 0.5 mm.

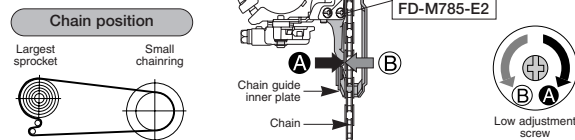

2. Connecting and securing the inner cable

Switch the mode converter to the 3x (triple mode) position, and then check the lowest position. Operate lever B two times or more to set the lever to the lowest position. Remove the inner hole cover, and install the cable.

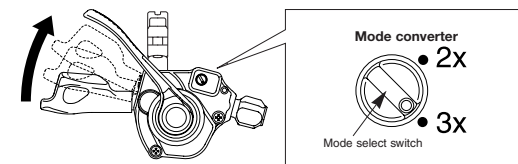
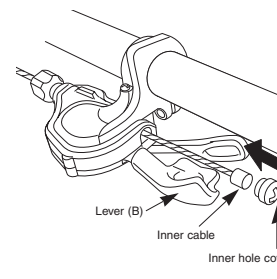

**Note:**

Do not force the mode select switch to turn. If you force it to turn, it will break.

Operate lever A once to set it to the middle position. Switch the mode converter to the 2x (double mode) position.

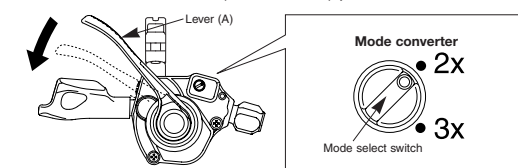

**Note:**

The mode converter cannot be switched while the lever is at the lowest position. Be sure to operate lever (A) one or more times before switching. Do not turn the mode converter by force, otherwise it may break.

Install the inner hole cover by turning it as shown in the illustration until it stops. Do not turn it any further than this, otherwise it may damage the thread on the cover.

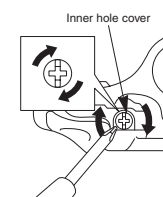

Cutting the outer casing

When cutting the outer casing, cut the opposite end to the end with the marking. After cutting the outer casing, make the end round so that the inside of the hole has a uniform diameter.



Attach the same outer end cap to the cut end of the outer casing.

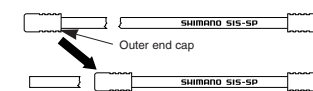

• FD-M785 / FD-M785-E2

Use an 8 mm spanner or a 4 mm Allen key to tighten the wire fixing bolt.

< Normal type >

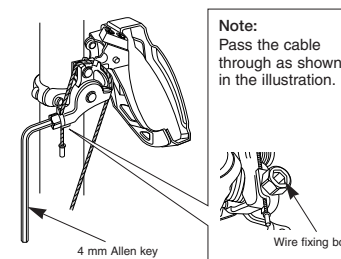

**Note:**  
Pass the cable through as shown in the illustration.

< Top route type >

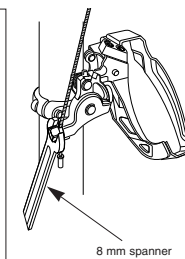

• FD-M786 / FD-M786-D

< Normal type >

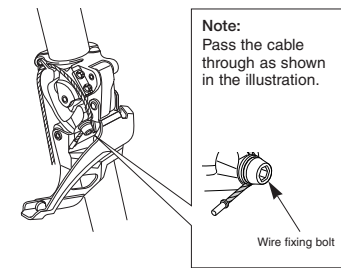

**Note:**  
Pass the cable through as shown in the illustration.

< Top route type >

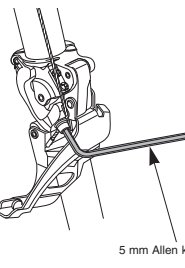

Tightening torque :  
6 - 7 N·m {52 - 60 in. lbs.}

After taking up the initial slack in the cable, re-secure to the front derailleur as shown in the illustration.

Normal type

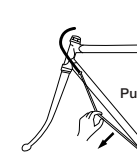

Top route type

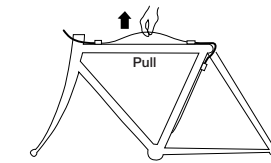

3. Adjustment of the cable tension

(1) Set the chain to the largest rear sprocket, and shift to the large chainring.

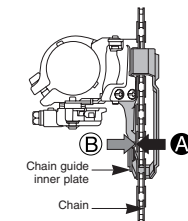
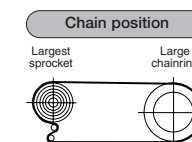

(2) Adjust using the outer casing adjustment barrel so that the clearance between the chain guide inner plate and the chain is 0 - 0.5 mm.

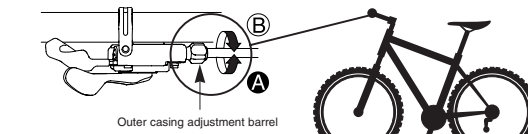

4. Top adjustment

Set so that the clearance between the chain guide outer plate and the chain is 0 - 0.5 mm.

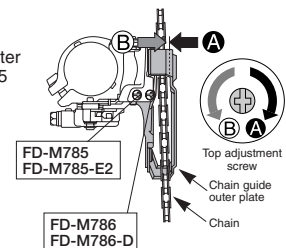
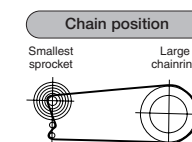

5. Troubleshooting chart

After completion of steps 1 - 4, move the shifting lever to check the shifting. (This also applies if shifting becomes difficult during use.)

If the chain falls to the crank side.	Tighten the top adjustment screw clockwise (about 1/4 turn).
If shifting is difficult from the small chainring to the large chainring.	Loosen the top adjustment screw counterclockwise (about 1/8 turn). If it still does not solve the problem, adjust the cable tension again.
If shifting is difficult from the large chainring to the small chainring.	Loosen the low adjustment screw counterclockwise (about 1/4 turn).
If there is interference between the chain and the front derailleur inner plate when the chain is on the large chainring and the largest sprocket.	Tighten the top adjustment screw clockwise (about 1/8 turn). If this still does not solve the problem, tighten the outer casing adjustment barrel by turning it clockwise by 1 to 2 turns.
If there is interference between the chain and the front derailleur outer plate at the large chainring.	Loosen the top adjustment screw by turning it counterclockwise (about 1/2 turn). If this still does not solve the problem, loosen the outer casing adjustment barrel by turning it counterclockwise by 1 to 2 turns.
If the chain falls to the bottom bracket side.	Tighten the low adjustment screw clockwise (about 1/2 turn).

**SHIMANO**

SHIMANO AMERICAN CORPORATION  
One Holland, Irvine, California 92618, U.S.A. Phone: +1-949-951-5003

SHIMANO EUROPE B.V.  
Industrieweg 24, 8071 CT Nunspeet, The Netherlands Phone: +31-341-272222

SHIMANO INC.  
3-77 Oimatsu-cho, Sakai-ku, Sakai-shi, Osaka 590-8577, Japan

\* Service Instructions in further languages are available at :  
<http://techdocs.shimano.com>

Please note: specifications are subject to change for improvement without notice. (English)  
© Jan. 2011 by Shimano Inc. XBC SZK Printed in Japan.