

# Dealer's Manual

ROAD	MTB	Trekking
City Touring/ Comfort Bike	URBAN SPORT	E-BIKE

# Rear Derailleur

**DEORE XT**  
RD-T8000

# CONTENTS

<b>IMPORTANT NOTICE</b> .....	<b>3</b>
<b>TO ENSURE SAFETY</b> .....	<b>4</b>
<b>LIST OF TOOLS TO BE USED</b> .....	<b>7</b>
<b>INSTALLATION</b> .....	<b>9</b>
Installation of the rear derailleur (direct mount) .....	9
Replacing with direct mount type .....	9
<b>ADJUSTMENT</b> .....	<b>11</b>
Adjustment of the end adjust bolt (SHADOW RD) .....	11
SIS adjustment (SHADOW RD).....	12
<b>MAINTENANCE</b> .....	<b>14</b>
Replacement of the plate and the plate tension spring.....	14
Replacement of the pulley .....	16

## IMPORTANT NOTICE

- **This dealer's manual is intended primarily for use by professional bicycle mechanics.**

Users who are not professionally trained for bicycle assembly should not attempt to install the components themselves using the dealer's manuals. If any part of the information on the manual is unclear to you, do not proceed with the installation. Instead, contact your place of purchase or a local bicycle dealer for their assistance.

- Make sure to read all instruction manuals included with the product.
- Do not disassemble or modify the product other than as stated in the information contained in this dealer's manual.
- All dealer's manuals and instruction manuals can be viewed on-line on our website (<http://si.shimano.com>).
- Please observe the appropriate rules and regulations of the country, state or region in which you conduct your business as a dealer.

**For safety, be sure to read this dealer's manual thoroughly before use, and follow it for correct use.**

The following instructions must be observed at all times in order to prevent personal injury and physical damage to equipment and surroundings. The instructions are classified according to the degree of danger or damage which may occur if the product is used incorrectly.

 **DANGER**

Failure to follow the instructions will result in death or serious injury.

 **WARNING**

Failure to follow the instructions could result in death or serious injury.

 **CAUTION**

Failure to follow the instructions could cause personal injury or physical damage to equipment and surroundings.

## TO ENSURE SAFETY

### WARNING

- **Be sure to follow the instructions provided in the manuals when installing the product.**  
It is recommended to use genuine Shimano parts only. If parts such as bolts and nuts become loose or damaged, the bicycle may suddenly fall over, which may cause serious injury.  
In addition, if adjustments are not carried out correctly, problems may occur, and the bicycle may suddenly fall over, which may cause serious injury.
-  Be sure to wear safety glasses or goggles to protect your eyes while performing maintenance tasks such as replacing parts.
- After reading the dealer's manual thoroughly, keep it in a safe place for later reference.

#### Be sure to also inform users of the following:

- *Intervals between maintenance depend on the use and riding circumstances. Clean the chain with an appropriate chain cleaner regularly. Never use alkali based or acid based solvents, such as rust cleaners. If those solvent be used chain might break and cause serious injury.*
- Check the chain for any damage (deformation or crack), skipping, or other abnormalities such as unintended gear shifting. If any problems are found, consult a dealer or an agency. The chain may break, and you may fall.

### CAUTION

#### For Installation to the Bicycle, and Maintenance:

- When installing and removing the plate unit, be careful not to get your fingers caught in the strong reaction force of the plate tension spring.

### NOTE

#### Be sure to also inform users of the following:

- If gear shifting operations do not feel smooth, wash the derailleur and lubricate all moving parts.
- If looseness in the links is so great that gear shifting adjustments cannot be made, replace the derailleur.
- Products are not guaranteed against natural wear and deterioration from normal use and aging.
- For maximum performance we highly recommend Shimano lubricants and maintenance products.

#### For Installation to the Bicycle, and Maintenance:

- Depending on the shape of the frame, the rear derailleur may interfere with the chainstay.
- Using a frame with internal cable routing is strongly discouraged as it has tendencies to impair the SIS shifting function due to its high cable resistance.
- Grease the inner cable and the inside of the outer casing before use to ensure that they slide properly.
- Do not let dust adhere on the inner cable. If the grease on the inner cable is wiped off, the application of SIS SP41 grease (Y04180000) is recommended. Do not use DURA-ACE grease or other types of grease, otherwise it may deteriorate gear shifting performance.
- Use an OT-SP sealed outer casing and cable guide for smooth operation.
- Use an outer casing which still has some length to spare even when the handlebars are turned all the way to both sides. Furthermore, check that the shifting lever does not touch the bicycle frame when the handlebars are turned all the way.
- If gear shifting adjustments cannot be carried out, check that the rear fork ends are aligned, whether the cable is lubricated and that the outer casing is not too long or short.
- Periodically clean the derailleur and lubricate all moving parts (mechanism and pulleys).

## TO ENSURE SAFETY





- Depending on the model, the guide pulley has arrows on it to indicate the direction of rotation. Install the guide pulley so that the arrows are pointing counterclockwise when looking at the outer side of the derailleur.
- The tension pulley has an arrow on it to indicate the direction of rotation. Install the tension pulley so that the arrow is pointing clockwise when looking at the outer side of the derailleur.
- If you hear abnormal noise as a result of looseness in a pulley, you should replace the pulley.

The actual product may differ from the illustration because this manual is intended mainly to explain the procedures for using the product.

# LIST OF TOOLS TO BE USED

# LIST OF TOOLS TO BE USED

The following tools are needed for installation, adjustment, and maintenance purposes.

Tool		Tool		Tool	
	2mm Allen key		4mm Allen key		Screwdriver[#2]
	3mm Allen key		5mm Allen key		

# INSTALLATION



## INSTALLATION

### ►► Installation of the rear derailleur (direct mount)

# INSTALLATION

Refer to "REAR DERAILLEUR FOR MTB/TREKKING" in "General Operations" for installation to the frame.

## ■ Installation of the rear derailleur (direct mount)

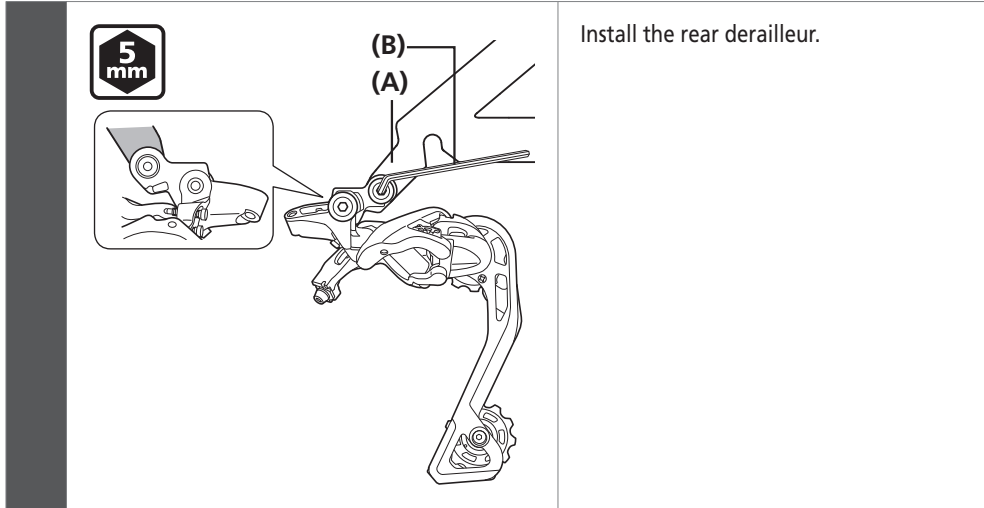

- (A) Fork end
- (B) 5mm Allen key

### Tightening torque



8 - 10 N·m

### NOTE

Direct mount rear derailleurs can only be installed to frames that support direct mounting.

## ■ Replacing with direct mount type

When replacing the direct mount type with the bracket-equipped type, reverse the procedure.

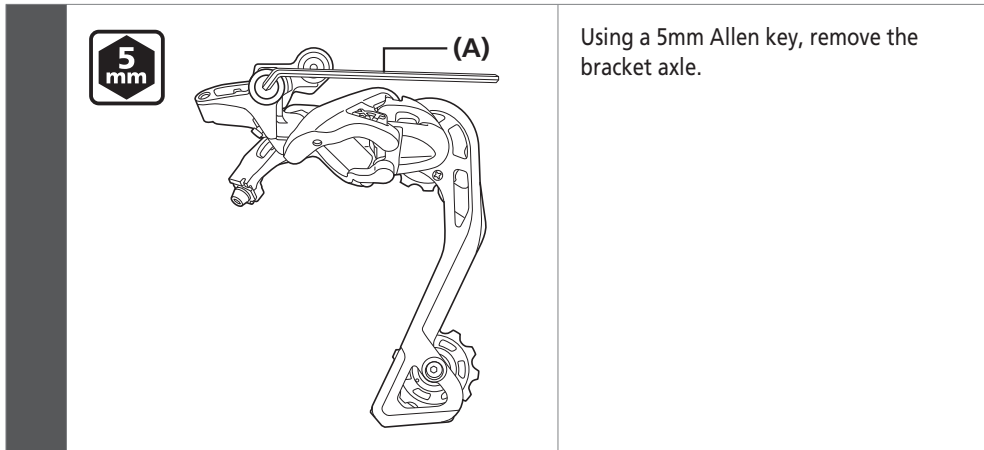

- (A) 5mm Allen key

### Tightening torque



8 - 10 N·m

# ADJUSTMENT

# ADJUSTMENT

This section describes the adjustment procedure for the SHADOW RD.  
Refer to "Rear derailleur" in "General Operations" for details not provided here.

## ■ Adjustment of the end adjust bolt (SHADOW RD)

**1** Set the rear derailleur to the largest sprocket.

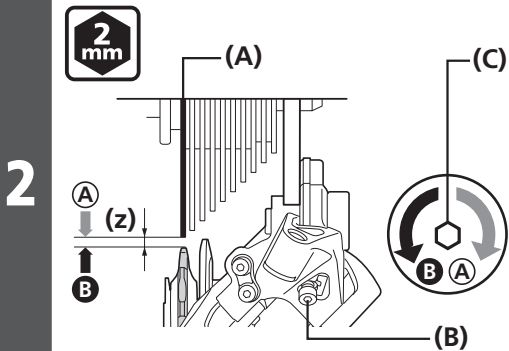

After stopping the wheel, check that the distance between the tip of the guide pulley and the edge of the sprocket is within the range shown in the illustration.

(z) 5 - 6mm

(A) Largest sprocket

(B) End adjust bolt

(C) 2mm Allen key

**3** Turn the crank and shift gears to check that other gears do not feel rough.

## ADJUSTMENT

### ▶▶ SIS adjustment (SHADOW RD)

## ■ SIS adjustment (SHADOW RD)

**1** Operate the shifting lever once to move the chain to the 2nd sprocket.

Then, while operating the lever just enough to close the gap in the lever, turn the crank arm.

### When shifting to 3rd

- Tighten the adjustment bolt until the chain returns to the 2nd sprocket. (Clockwise)

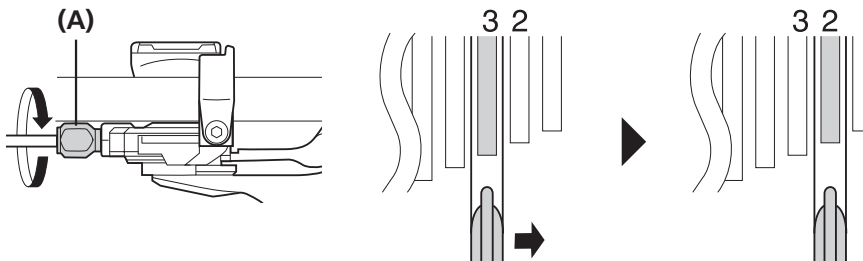

**2**

### When no sound at all is generated

- Loosen the bolt until the chain touches the 3rd sprocket and makes noise. (Counterclockwise)

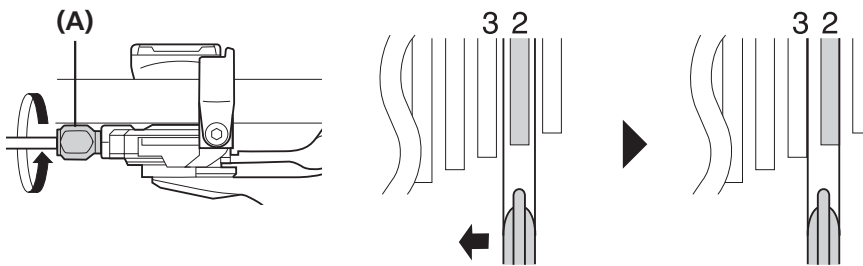

**3**

Return the lever to its original position (the position where the lever is at the 2nd sprocket setting and it has been released) and then turn the crank arm clockwise.

**4**

Operate lever to change gears, and check that no noise occurs in any of the gear positions.

**5**

For the best SIS performance, periodically lubricate all power-transmission parts.

**(A)** Adjustment bolt



### TECH TIPS

The best setting is when the shifting lever is operated just enough to close the lever gap and the chain touches the 3rd sprocket and makes noise.

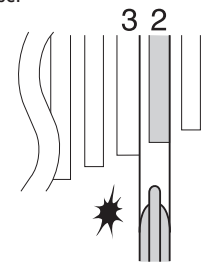

### TECH TIPS

If the chain is touching the 3rd sprocket and making noise, turn the adjustment bolt clockwise slightly to tighten it just until the noise stops and the chain runs smoothly.

# MAINTENANCE

# MAINTENANCE

## ■ Replacement of the plate and the plate tension spring

### Removal

1

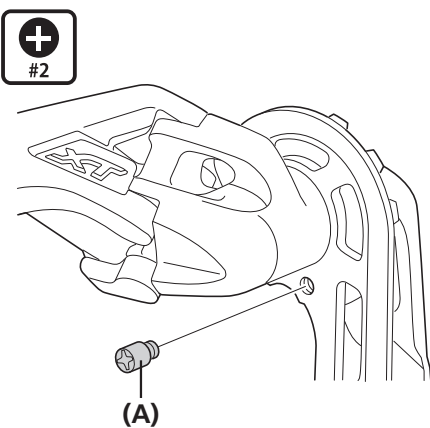

Remove the plate stopper pin.

**(A)** Plate stopper pin

Tightening torque	
	1 N·m

2

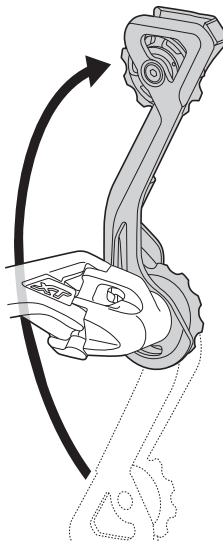

Turn the plate to loosen the plate tension spring as shown in the illustration.

3

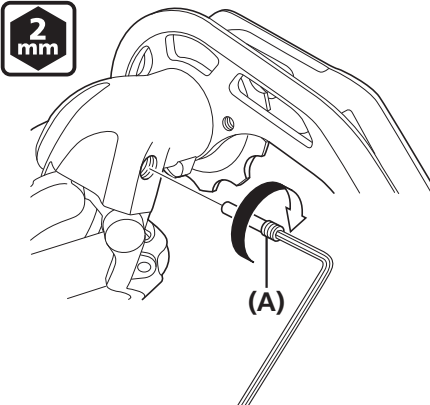

Using a 2mm Allen key, remove the stopper bolt.

**(A)** Stopper bolt

Tightening torque	
	1 N·m

▶▶ Replacement of the plate and the plate tension spring

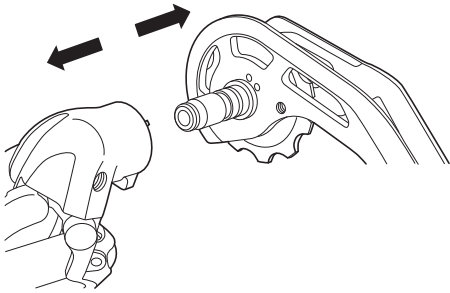
4		Detach the plate.
---	-----------------------------------------------------------------------------------	-------------------

**Cautions when assembling**

Assemble by carrying out the removal procedure in reverse while adhering to the following cautions.

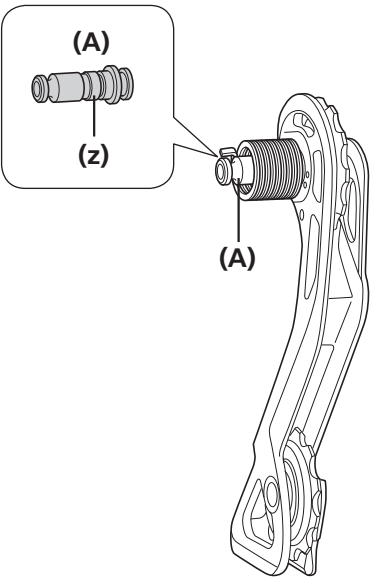
1		Apply grease to the plate axle. <b>(z)</b> Apply grease.
---	------------------------------------------------------------------------------------	-------------------------------------------------------------

**(A)** Plate axle

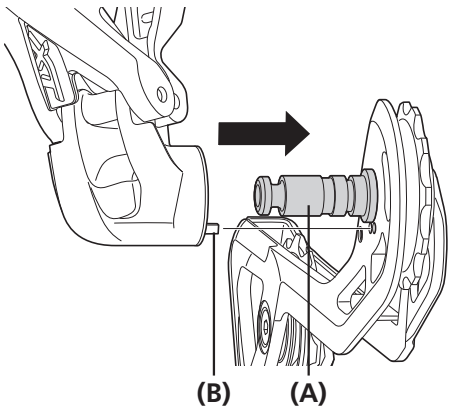
2		When reassembling, insert the end of the plate tension spring into the groove in the plate.
---	-------------------------------------------------------------------------------------	---------------------------------------------------------------------------------------------

**(A)** Plate axle  
**(B)** Plate tension spring

## ■ Replacement of the pulley

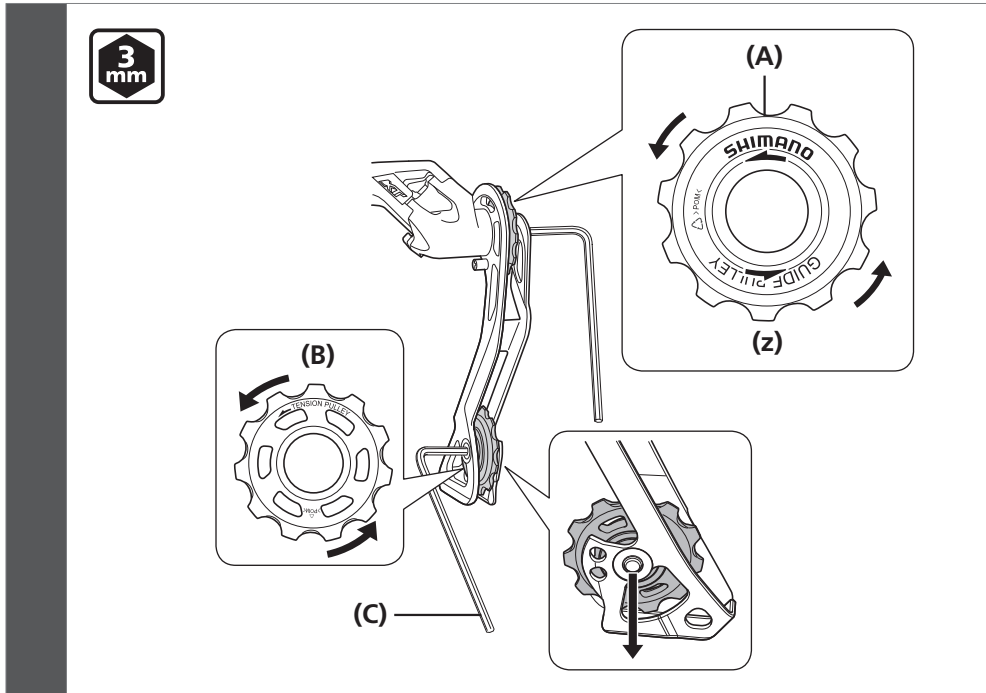

(z) With arrows

(A) Guide pulley

(B) Tension pulley

(C) 3mm Allen key

**Tightening torque**



2.5 - 5 N·m



# SHIMANO

## **SHIMANO AMERICAN CORPORATION**

One Holland, Irvine, California 92618, U.S.A. Phone: +1-949-951-5003

## **SHIMANO EUROPE B.V.**

Industrieweg 24, 8071 CT Nunspeet, The Netherlands Phone: +31-341-272222

## **SHIMANO INC.**

3-77 Oimatsu-cho, Sakai-ku, Sakai-shi, Osaka 590-8577, Japan

Please note: specifications are subject to change for improvement without notice. (English)

© Feb. 2016 by Shimano Inc. HTR