

Dealer's Manual

ROAD	MTB	Trekking
City Touring/ Comfort Bike	URBAN SPORT	E-BIKE

Cassette sprocket

CS-HG400-9

CS-HG50-8

CONTENTS

IMPORTANT NOTICE.....	3
TO ENSURE SAFETY.....	4
LIST OF TOOLS TO BE USED.....	6
INSTALLATION	8
Installation of cassette sprocket.....	8
Sprocket pattern	9

IMPORTANT NOTICE

- **This dealer's manual is intended primarily for use by professional bicycle mechanics.**

Users who are not professionally trained for bicycle assembly should not attempt to install the components themselves using the dealer's manuals. If any part of the information on the manual is unclear to you, do not proceed with the installation. Instead, contact your place of purchase or a local bicycle dealer for their assistance.

- Make sure to read all instruction manuals included with the product.
- Do not disassemble or modify the product other than as stated in the information contained in this dealer's manual.
- All dealer's manuals and instruction manuals can be viewed on-line on our website (<http://si.shimano.com>).
- Please observe the appropriate rules and regulations of the country, state or region in which you conduct your business as a dealer.

For safety, be sure to read this dealer's manual thoroughly before use, and follow it for correct use.

The following instructions must be observed at all times in order to prevent personal injury and physical damage to equipment and surroundings. The instructions are classified according to the degree of danger or damage which may occur if the product is used incorrectly.



Failure to follow the instructions will result in death or serious injury.



Failure to follow the instructions could result in death or serious injury.



Failure to follow the instructions could cause personal injury or physical damage to equipment and surroundings.

TO ENSURE SAFETY

WARNING

- **Be sure to follow the instructions provided in the manuals when installing the product.**
It is recommended to use genuine Shimano parts only. If parts such as bolts and nuts become loose or damaged, the bicycle may suddenly fall over, which may cause serious injury.
In addition, if adjustments are not carried out correctly, problems may occur, and the bicycle may suddenly fall over, which may cause serious injury.
-  Be sure to wear safety glasses or goggles to protect your eyes while performing maintenance tasks such as replacing parts.
- After reading the dealer's manual thoroughly, keep it in a safe place for later reference.

NOTE

Be sure to also inform users of the following:

- If the chain keeps coming off the gears during use, replace the gears and the chain.
- Products are not guaranteed against natural wear and deterioration from normal use and aging.
- For maximum performance we highly recommend Shimano lubricants and maintenance products.

For Installation to the Bicycle, and Maintenance:

- The gears should be periodically washed with a neutral detergent. In addition, cleaning the chain with neutral detergent and lubricating it can be an effective way of extending the life of the gears and the chain.
- Always use the recommended combination of gears.
- Always be sure to use the sprocket set bearing the same group marks; never use in combination with a sprocket bearing a different group mark.
(Depending on the tooth combination, some may not have a mark.)

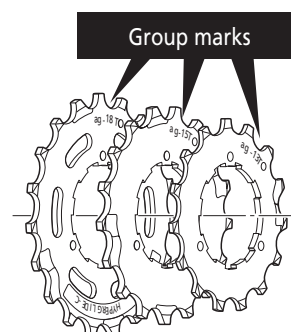





- Always use CS-HG400-9 in combination with CN-7701, CN-HG93, CN-HG73, or CN-HG53. Other chains cannot be used because the dimensions do not match.
- Always use CS-HG50-8 in combination with CN-HG40 or CN-HG71. Other chains cannot be used because the dimensions do not match.

The actual product may differ from the illustration because this manual is intended mainly to explain the procedures for using the product.

LIST OF TOOLS TO BE USED

LIST OF TOOLS TO BE USED

The following tools are needed for installation, adjustment, and maintenance purposes.

Tool		Tool	
 TL-LR15	TL-LR15	 TL-SR21	TL-SR21
 Adjustable wrench	Adjustable wrench	 TL-SR23	TL-SR23

INSTALLATION

INSTALLATION

■ Installation of cassette sprocket

1

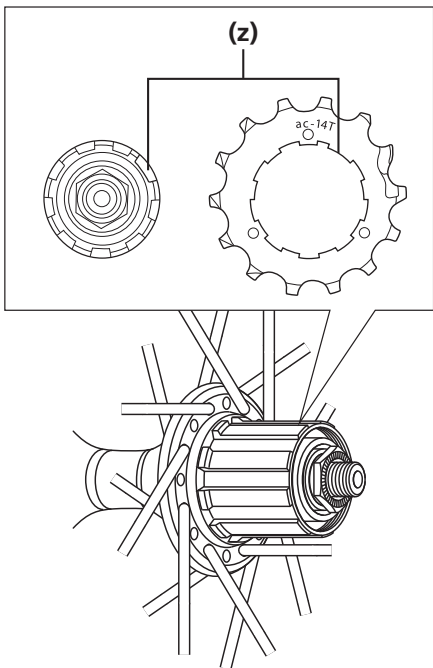

When setting the sprockets, set each one so that the surface that has the group mark faces outward and so that the wide groove area on the freewheel body is aligned with the wide groove area on each sprocket.

(z) Wide part



There is only one wide groove area on the freewheel body and on each sprocket. Check when setting the sprockets.

2

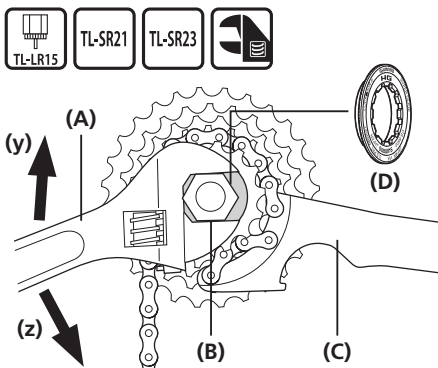

Installing HG sprockets:
Tighten the lock ring with the Shimano original tool TL-LR15.

Replacing HG sprockets:
Remove the lock ring with the Shimano original tools TL-LR15 and TL-SR21/SR23.

- (y)** Assembly
- (z)** Disassembly

- (A)** Adjustable wrench
- (B)** TL-LR15
- (C)** TL-SR21/SR23
- (D)** Lock ring

Tightening torque

 TL-LR15 TL-SR21/SR23	<p>30 - 50 N·m</p>
-------------------------------------	--------------------

NOTE

Set TL-SR21/SR23 on a sprocket smaller than the middle sprocket. If it is set on a sprocket larger than the middle sprocket, the tool will not be stable.

Sprocket pattern

CS-HG400-9

11T-32T (ar), 11T-34T (au), 11T-36T (cb)

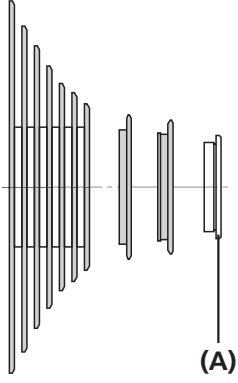

12T-36T (bh) (MTB)

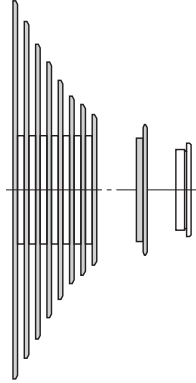

- (A) Lock ring
- (B) Sprocket spacers

11T-28T (bg)

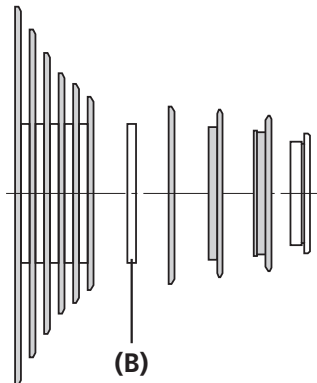

11-25T(G)

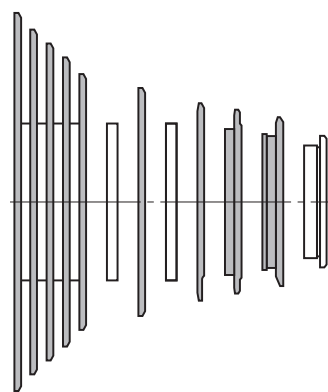

CS-HG50-8

11-28T (bf), 11-30T (an), 11-32T (aw), 11-34T (ca)

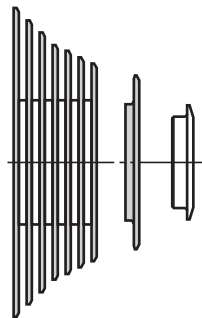

SHIMANO

SHIMANO AMERICAN CORPORATION

One Holland, Irvine, California 92618, U.S.A. Phone: +1-949-951-5003

SHIMANO EUROPE B.V.

High Tech Campus 92, 5656 AG Eindhoven, The Netherlands Phone: +31-402-612222

SHIMANO INC.

3-77 Oimatsu-cho, Sakai-ku, Sakai-shi, Osaka 590-8577, Japan

Please note: specifications are subject to change for improvement without notice. (English)

© Jan. 2017 by Shimano Inc. ITP