

## Dealer's Manual

ROAD	MTB	Trekking
City Touring/ Comfort Bike	URBAN SPORT	E-BIKE

# Front derailleur

## DURA-ACE

FD-R9100

## ULTEGRA

FD-R8000

## 105

FD-5801

FD-R7000

Procedures for cable tension adjustment and top adjustment differ from those of previous models. Be sure to read this dealer's manual thoroughly before use, and follow it for correct use.

# CONTENTS

<b>IMPORTANT NOTICE.....</b>	<b>3</b>
<b>TO ENSURE SAFETY.....</b>	<b>4</b>
<b>LIST OF TOOLS TO BE USED.....</b>	<b>7</b>
<b>INSTALLATION .....</b>	<b>9</b>
Brazed-on type.....	9
Band type.....	12
Installation of the front derailleur using a band adapter (SM-AD91) .....	13
<b>ADJUSTMENT .....</b>	<b>15</b>
Connection and securing of inner cable.....	15
Adjustment of cable tension .....	18
Top adjustment .....	19
Low adjustment.....	20
Routing and cutting excess cable.....	21
Troubleshooting chart .....	22
<b>MAINTENANCE.....</b>	<b>24</b>
Replacing the skid plate .....	24

## IMPORTANT NOTICE

- **This dealer's manual is intended primarily for use by professional bicycle mechanics.**

Users who are not professionally trained for bicycle assembly should not attempt to install the components themselves using the dealer's manuals. If any part of the information on the manual is unclear to you, do not proceed with the installation. Instead, contact your place of purchase or a local bicycle dealer for their assistance.

- Make sure to read all instruction manuals included with the product.
- Do not disassemble or modify the product other than as stated in the information contained in this dealer's manual.
- All dealer's manuals and instruction manuals can be viewed on-line on our website (<http://si.shimano.com>).
- Please observe the appropriate rules and regulations of the country, state or region in which you conduct your business as a dealer.

**For safety, be sure to read this dealer's manual thoroughly before use, and follow it for correct use.**

The following instructions must be observed at all times in order to prevent personal injury and physical damage to equipment and surroundings. The instructions are classified according to the degree of danger or damage which may occur if the product is used incorrectly.



Failure to follow the instructions will result in death or serious injury.



Failure to follow the instructions could result in death or serious injury.



Failure to follow the instructions could cause personal injury or physical damage to equipment and surroundings.

# TO ENSURE SAFETY

## ⚠ WARNING

- **Be sure to follow the instructions provided in the manuals when installing the product.**  
It is recommended to use genuine Shimano parts only. If parts such as bolts and nuts become loose or damaged, the bicycle may suddenly fall over, which may cause serious injury.  
In addition, if adjustments are not carried out correctly, problems may occur, and the bicycle may suddenly fall over, which may cause serious injury.
-  Be sure to wear safety glasses or goggles to protect your eyes while performing maintenance tasks such as replacing parts.
- After reading the dealer's manual thoroughly, keep it in a safe place for later reference.



**Be sure to also inform users of the following:**

- Be careful not to let the hemming of your clothes get caught in the chain while riding. Otherwise you may fall off the bicycle.

## NOTE

**Be sure to also inform users of the following:**

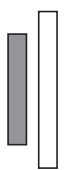
- If gear shifting operations cannot be carried out smoothly, clean the derailleur and lubricate all moving parts.
- When the chain is in any of the positions shown in the illustration, the chain may come into contact the front chainring or front derailleur and generate noise. If the noise is a problem, shift the chain to the second largest rear sprocket.

	Double
Front chainring	
Rear sprocket	

- Products are not guaranteed against natural wear and deterioration from normal use and aging.
- For maximum performance we highly recommend Shimano lubricants and maintenance products.

**For Installation to the Bicycle, and Maintenance:**

- Use an OT-SP sealed outer casing and cable guide for smooth operation.
- Grease the inner cable and the inside of the outer casing before use to ensure that they slide properly. Do not let dust adhere to the inner cable. If the grease on the inner cable is wiped off, the application of SIS SP41 grease (Y04180000) is recommended.
- If using a full outer casing, connect the end with the outer cap (resin type) to the derailleur.
- If using the bicycle in a cold region, use sealed outer cap (resin type) to protect against freezing.
- If looseness in the links is so great that gear shifting adjustments cannot be made, replace the derailleur.

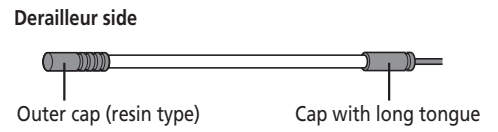





The actual product may differ from the illustration because this manual is intended mainly to explain the procedures for using the product.

# LIST OF TOOLS TO BE USED

## LIST OF TOOLS TO BE USED

The following tools are needed for installation, adjustment, and maintenance purposes.

Tool		Tool	
	2 mm hexagon wrench		5 mm hexagon wrench
	4 mm hexagon wrench		Nippers

# INSTALLATION



# INSTALLATION

## NOTE

With a carbon frame, even the recommended tightening torque may be too tight and cause damage to the frame, or too loose and not sufficiently attached to the frame. For the appropriate torque value, consult with the manufacturer of the completed bicycle or the manufacturer of the frame.

## ■ Brazed-on type

If installing the front derailleur to a brazed-on type frame, a backup plate must be attached to the seat tube. Always be sure to install the backup plate in order to prevent damage to the frame from the pressure applied by the support bolt of the front derailleur.

### Installation of the backup plate

Either 2 backup plates (a plate with a curved adhesion surface [1] and a plate with a flat surface [2]) or 1 backup plate (curved surface only [1]) will be included.

If 2 plates are included, use whichever type matches the shape of the frame.

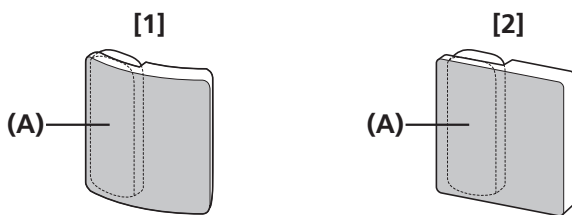

(A) Tape

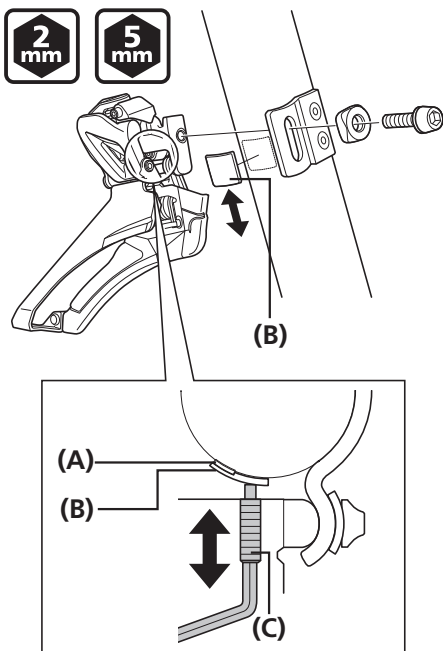

Check the position where the support bolt directly touches the frame when the support bolt of the front derailleur is being adjusted, and attach the backup plate in that position.

In addition, avoid positioning the tape that attaches the backup plate to the seat tube in the location where the support bolt directly touches the frame.

(A) Tape  
(B) Backup plate  
(C) Support bolt

## Installation of the front derailleur

1

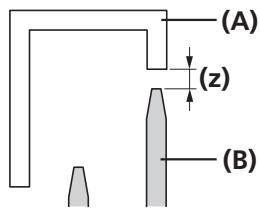

Adjust so that there is a clearance of 1 – 3 mm between the chain guide outer plate and the largest chainring.

After this, tentatively tighten the clamp bolt.

**(z)** 1 – 3 mm

- (A)** Chain guide
- (B)** Largest chainring

2

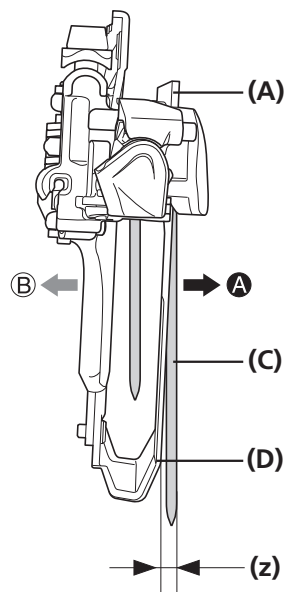
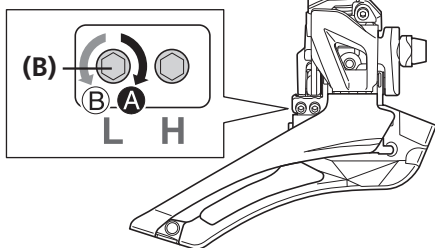

Adjust the low adjustment bolt and align the front end of the chain guide outer plate parallel to the surface of the largest chainring.

At this point, adjust the chain guide so that its rear end is 0.5 – 1.0 mm inside.

**(z)** 0.5 – 1 mm

- (A)** Front end of chain guide outer plate
- (B)** Low adjustment bolt
- (C)** Largest chainring
- (D)** Rear end of chain guide

3

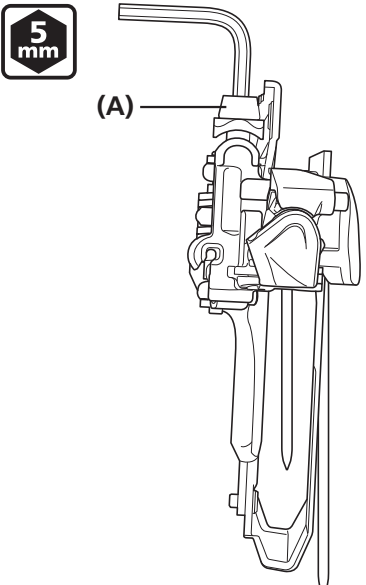

When the adjustment is complete, tighten the clamp bolt.

**(A)** Clamp bolt

Tightening torque	
	5 - 7 N·m

4

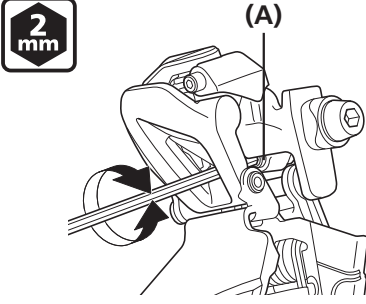

Adjustment is complete

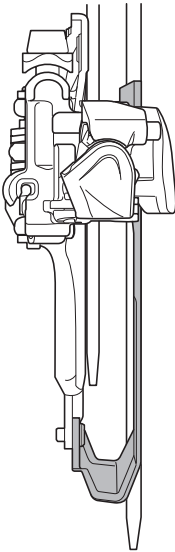

Adjust the support bolt so that the flat portion of the outer plate of the chain guide is parallel to the surface of the largest chainring.

At that time, make sure that the support bolt is in contact with the backup plate.

**(A)** Support bolt

NOTE

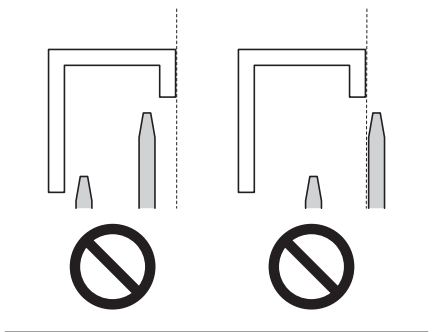

TECH TIPS

Check by holding a hexagon wrench against the flat surface of the largest chainring.

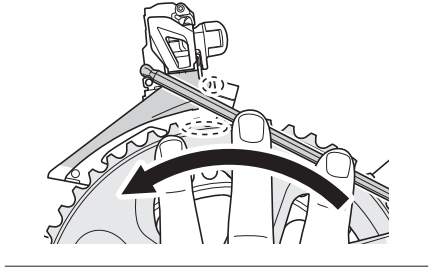

■ Band type

1

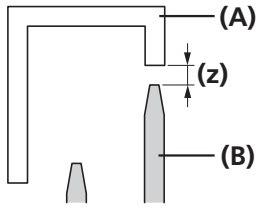

Adjust so that there is a clearance of 1 – 3 mm between the chain guide outer plate and the largest chainring.

After this, tentatively tighten the clamp bolt.

(z) 1 – 3 mm

- (A) Chain guide
- (B) Largest chainring

2

Adjust the low adjustment bolt and align the flat portion of the chain guide outer plate parallel to the surface of the largest chainring.

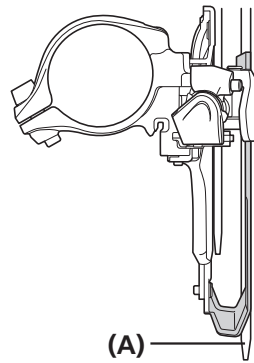
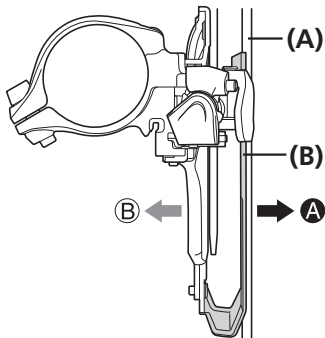
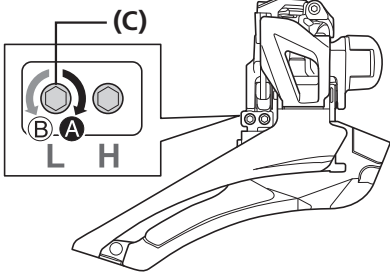

- (A) Largest chainring
- (B) Chain guide
- (C) Low adjustment bolt

NOTE

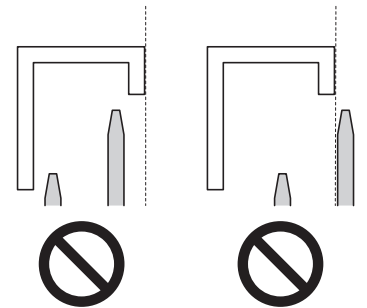

TECH TIPS

Check by holding a hexagon wrench against the flat surface of the largest chainring as shown in the illustration.

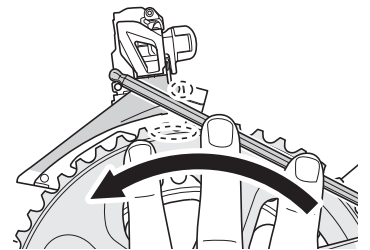

## INSTALLATION

### ▶ Installation of the front derailleur using a band adapter (SM-AD91)

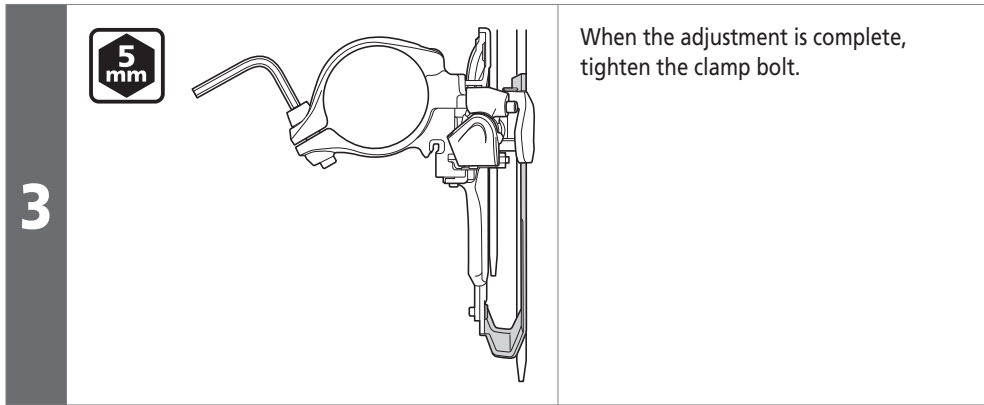

Tightening torque	
5 mm	5 - 7 N·m

## ■ Installation of the front derailleur using a band adapter (SM-AD91)

Use a support bolt even when installing the front derailleur using a band adapter (SM-AD91).

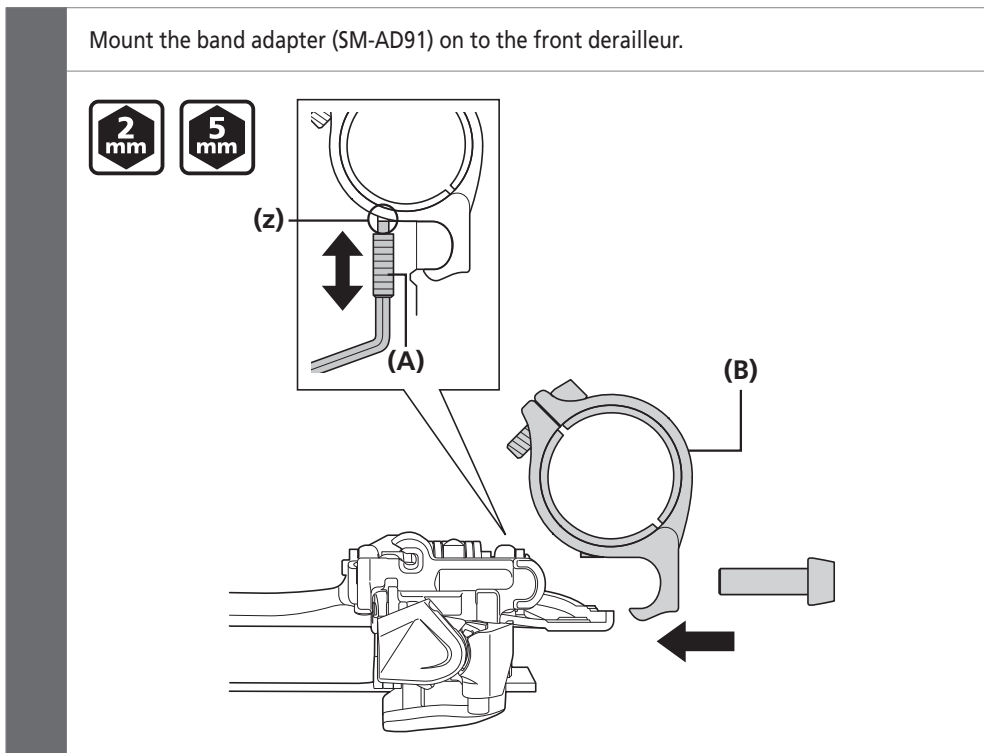

(z) Bring into contact

(A) Support bolt

(B) Band adapter

Tightening torque	
5 mm	5 - 7 N·m

For subsequent procedures, refer to the installation procedures for band types.

# ADJUSTMENT

# ADJUSTMENT

## ■ Connection and securing of inner cable

### Securing the cable

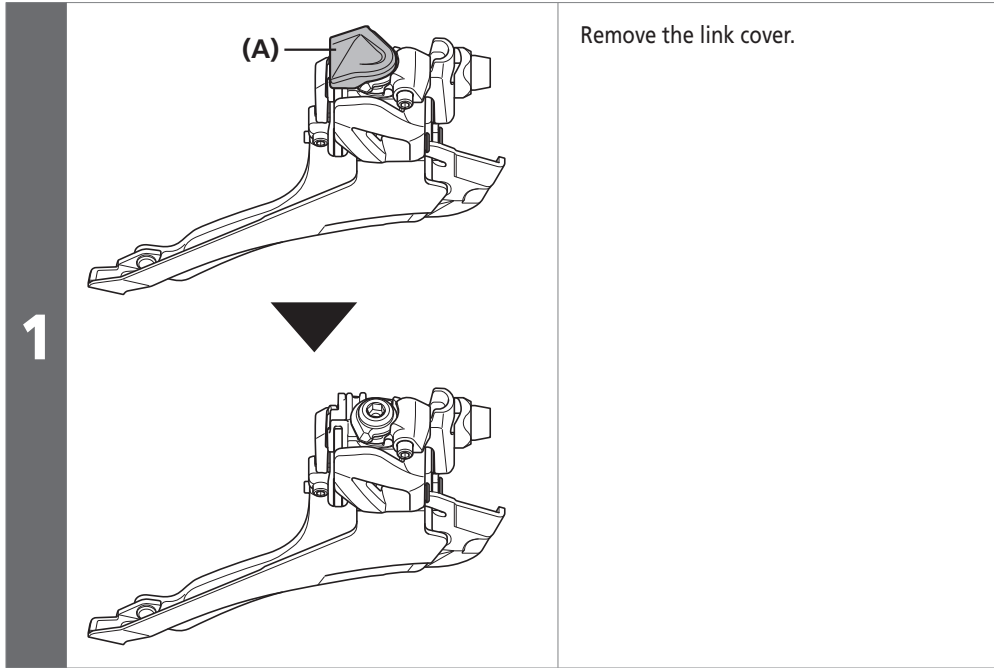

Remove the link cover.

(A) Link cover



TECH TIPS

When removing the link cover, lift it up while rotating it in the direction of the arrow as shown in the illustration.

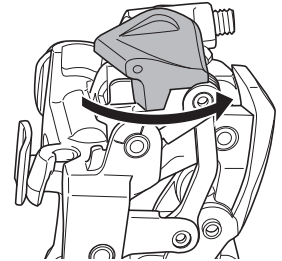

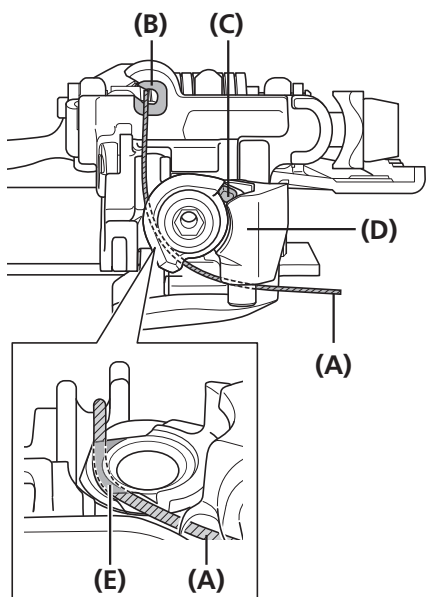

Adjust the low adjustment bolt to align the flat portion of the chain guide outer plate with the surface of the largest chainring, and then route the cable through as shown in the illustration. Confirm that the adjustment barrel protrusion is in contact with the input link.

If it is not in contact, loosen the cable adjustment barrel until contact is made and then route the cable.

Make sure to route the cable through the groove.

- (A) Inner cable
- (B) Cable guide
- (C) Adjustment barrel protrusion
- (D) Input link
- (E) Groove
- (F) Outer casing holder
- (G) Outer cap (resin type)
- (H) Outer casing

**NOTE**

- Make sure to check that the inner cable is routed through the cable guide.
- If using a full outer casing, connect the end with the outer cap (resin type) to the derailleur.
- If using the bicycle in a cold region, use sealed outer cap (resin type) to protect against freezing.

**2**

When using a full outer casing

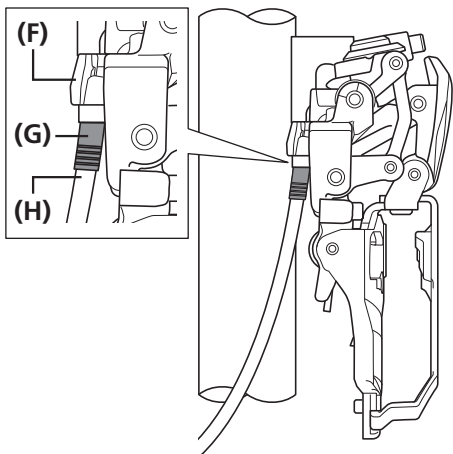

Make sure to secure the outer casing to the outer casing holder before use.

**Derailleur side**

Outer cap (resin type)



**TECH TIPS**

Fixing the cable with the chain guide outer plate and the surface of the largest chainring aligned, allows you to decrease the amount of cable tension adjustment when adjusting gear shifting.

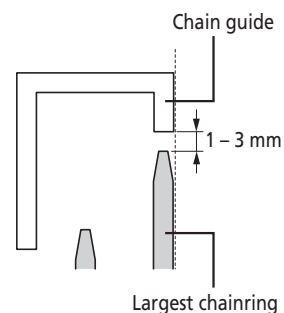

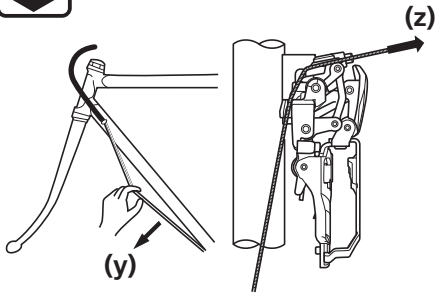

3

4  
mm

Tentatively secure the inner cable and remove the initial slack from the cable.

After that, fix the cable again while pulling it.

- (y) Remove the initial extension
- (z) Pull

## Tightening torque

4  
mm

6 - 7 N·m

## NOTE

- Take up the initial extension before installing the chain.
- If a chain is already installed, turn the crank as you operate the lever.
- Do not apply excessive force when operating the lever. Otherwise, the lever could malfunction.



## TECH TIPS

For a full outer model, operate the lever normally, move the front derailleur several times, and then remove the initial extension. After removing the initial extension, secure the cable in place and then adjust.

## ADJUSTMENT

### ▶ Adjustment of cable tension

## ■ Adjustment of cable tension

The gear where the lever is released from the top position (y) to the T-trim position (x) is the tension adjustment position.

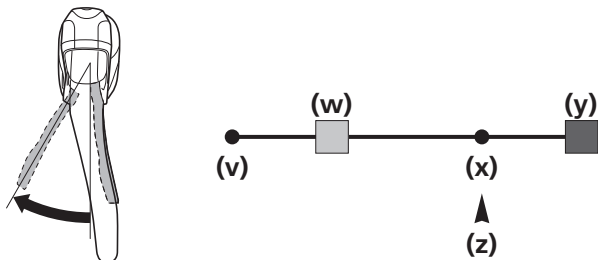

- (v) L-trim
- (w) Low
- (x) T-trim
- (y) Top
- (z) Tension adjustment position

Adjust the cable tension with the cable adjustment barrel (C) or cable adjuster on the frame so that the bracket indicator (B) or (E) is aligned with the input link indicator (A) or (D).

If the cable is tightened too much, make sure to release to the low position once while loosening the barrel. After this, check the position of the indicators again by checking the T-trim position.

Attach the chain after completing cable tension adjustment.

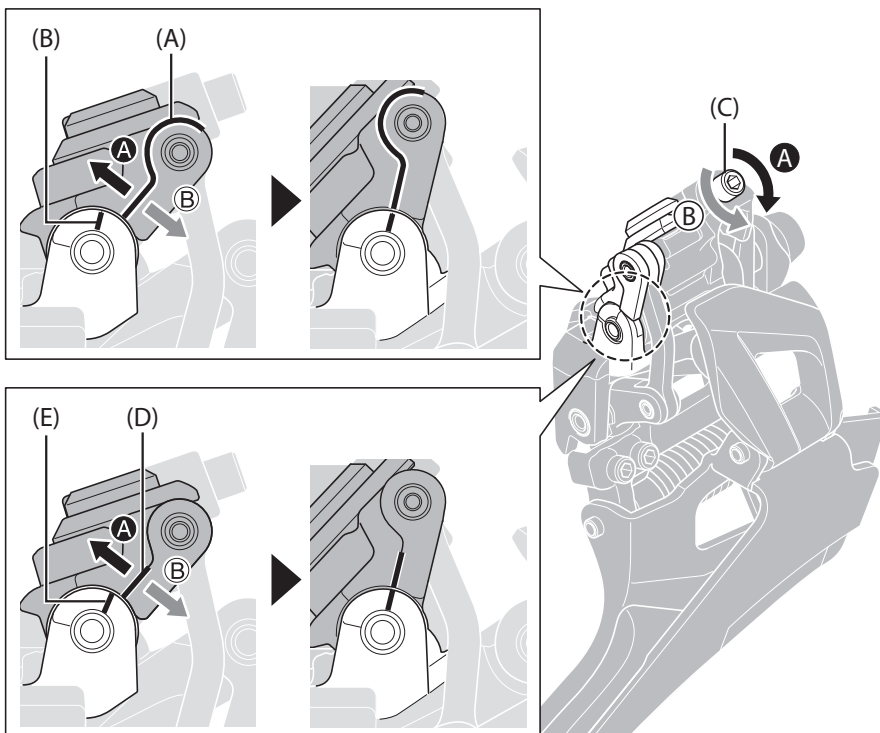

- (A) Input link indicator (level difference)
- (B) Bracket indicator (level difference)
- (C) Cable adjustment barrel
- (D) Input link indicator (line)
- (E) Bracket indicator (line)

### NOTE

There are types adjusted with (A) and (B), and types adjusted with (D) and (E). For types with a line, use (D) and (E) to adjust.

■ **Top adjustment**

The gear where the lever is released from the top position (y) to the T-trim position (x) is the tension adjustment position.

Shift the rear derailleur to engage the largest sprocket.

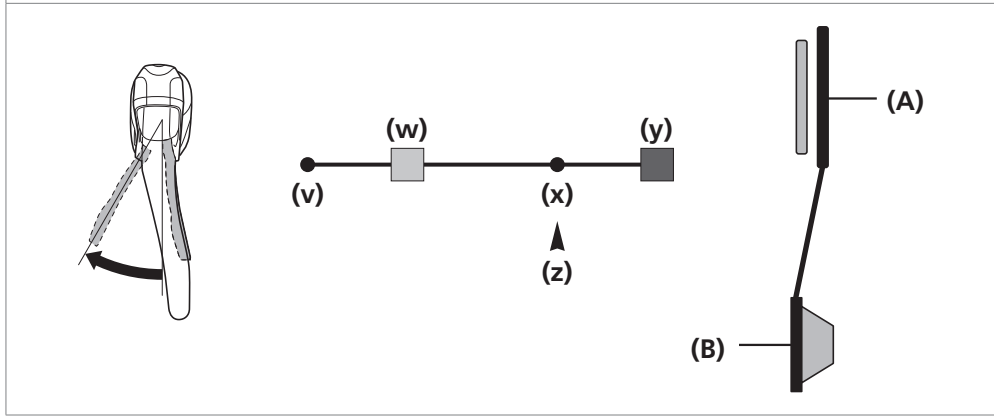

- (v) L-trim
- (w) Low
- (x) T-trim
- (y) Top
- (z) Top adjustment position

- (A) Largest chainring
- (B) Largest sprocket

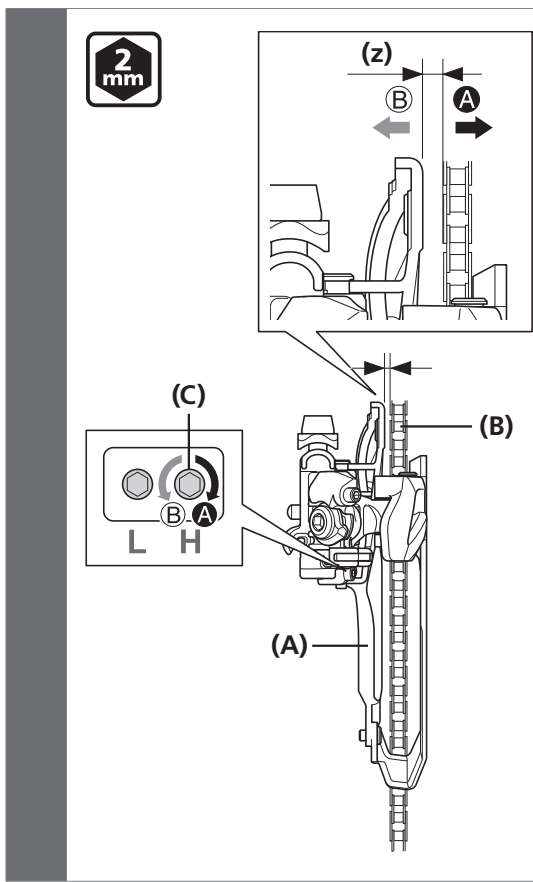

Adjust the top adjustment bolt so that the clearance between the chain guide inner plate and the chain is 0 - 0.5 mm.

(z) 0 - 0.5 mm

- (A) Chain guide inner plate
- (B) Chain
- (C) Top adjustment bolt

■ **Low adjustment**

The gear where the lever is released from the low position (w) to the L-trim position (v) is the low adjustment position.

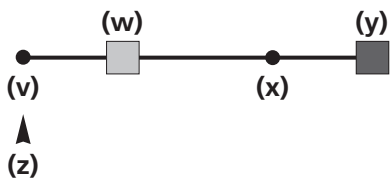
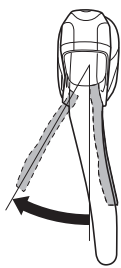

- (v) L-trim
- (w) Low
- (x) T-trim
- (y) Top
- (z) Low adjustment position

- (A) Smallest chainring
- (B) Largest sprocket

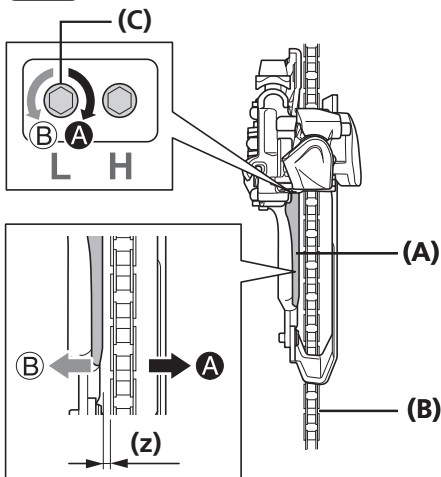

Adjust the low adjustment bolt so that the clearance between the skid plate of the chain guide and the chain is 0 - 0.5 mm.

(z) 0 - 0.5 mm

- (A) Skid plate (resin part)
- (B) Chain
- (C) Low adjustment bolt

## ■ Routing and cutting excess cable

**1**

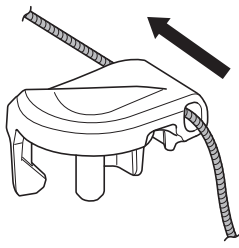

Pass the end of any remaining cable through the hole in the link cover.

**2**

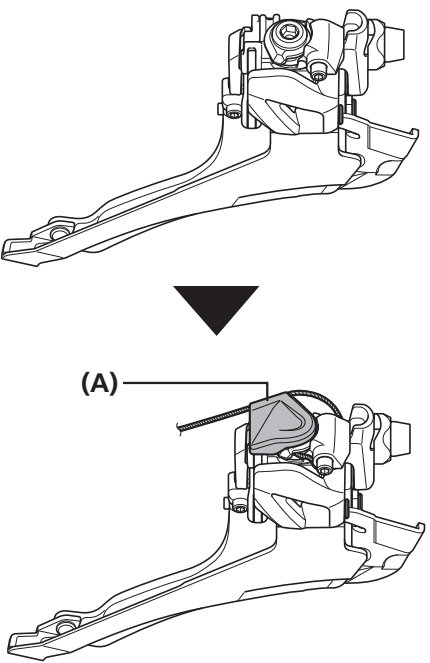

Attach the link cover.

(A) Link cover

**3**

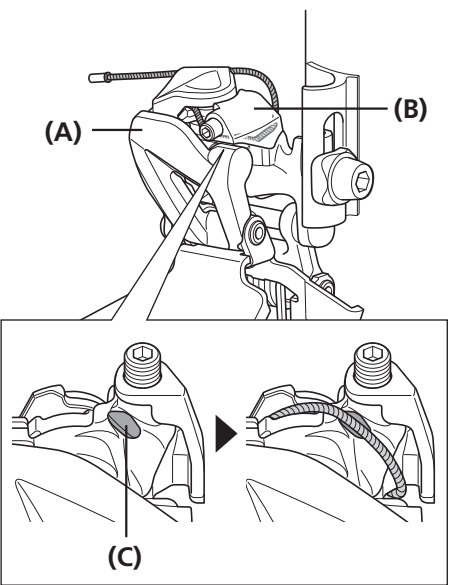

Route the cable as shown in the illustration.

Cut the cable and attach a cap to the end.

(A) Outer link  
 (B) Input link  
 (C) Groove

**NOTE**

When releasing to the L-trim position, make sure that the cable is not caught between the outer link and the input link.

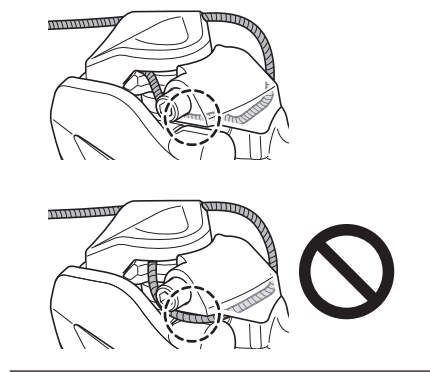

## ■ Troubleshooting chart

After the cable is installed and adjusted, check the gear-shift by operating the shifting lever.

If the chain falls to the crank side.	Turn the top adjustment bolt counterclockwise.
If shifting is difficult from the smallest chainring to the largest chainring.	Turn the top adjustment bolt clockwise.
If shifting is difficult from the largest chainring to the smallest chainring.	Turn the top adjustment bolt counterclockwise.
If the chain falls to the bottom bracket side when the gear is shifted to the lowest position.	Turn the top adjustment bolt clockwise.
If the chain falls to the bottom bracket side when the gear is shifted to the L-trim position.	Turn the low adjustment bolt clockwise.

### NOTE

- First check the indicator to determine whether cable tension is appropriate.
- This method for checking cable tension should also be used when gear shifting becomes difficult during use.

# MAINTENANCE

# MAINTENANCE

## ■ Replacing the skid plate

### Removing the skid plate

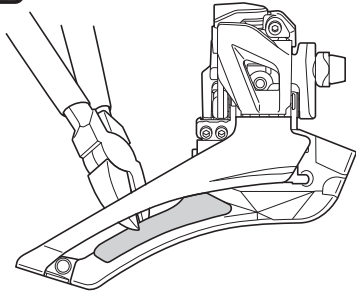

Make a slit in the skid plate at the position illustrated using nippers, and then remove the skid plate.

#### NOTE

The skid plate attached to the outer plate cannot be replaced.

### Mounting the skid plate

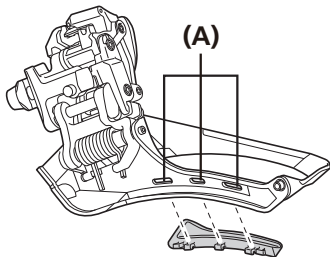
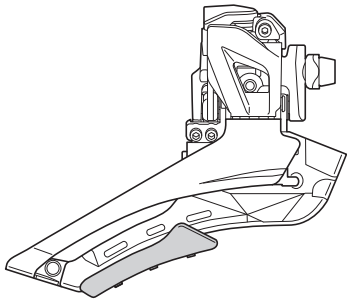

Insert the skid plate into the mounting holes.

After insertion, check that the claws of the skid plate are engaged properly on the back side.

**(A)** Mounting holes



# SHIMANO

**SHIMANO NORTH AMERICA BICYCLE, INC.**

One Holland, Irvine, California 92618, U.S.A. Phone: +1-949-951-5003

**SHIMANO EUROPE B.V.**

High Tech Campus 92, 5656 AG Eindhoven, The Netherlands Phone: +31-402-612222

**SHIMANO INC.**

3-77 Oimatsu-cho, Sakai-ku, Sakai-shi, Osaka 590-8577, Japan

Please note: specifications are subject to change for improvement without notice. (English)

© Mar. 2018 by Shimano Inc. ITP