

## Dealer's Manual

ROAD	MTB	Trekking
City Touring/ Comfort Bike	URBAN SPORT	E-BIKE

# Cassette Sprocket

### **DURA-ACE**

CS-R9100

### **ULTEGRA**

CS-R8000

CS-HG800-11

**CONTENTS**

**IMPORTANT NOTICE..... 3**

**TO ENSURE SAFETY..... 4**

**LIST OF TOOLS TO BE USED..... 6**

**INSTALLATION ..... 8**

    Installing cassette sprocket.....8

## IMPORTANT NOTICE

- **This dealer's manual is intended primarily for use by professional bicycle mechanics.**

Users who are not professionally trained for bicycle assembly should not attempt to install the components themselves using the dealer's manuals. If any part of the information on the manual is unclear to you, do not proceed with the installation. Instead, contact your place of purchase or a local bicycle dealer for their assistance.

- Make sure to read all instruction manuals included with the product.
- Do not disassemble or modify the product other than as stated in the information contained in this dealer's manual.
- All dealer's manuals and instruction manuals can be viewed on-line on our website (<http://si.shimano.com>).
- Please observe the appropriate rules and regulations of the country, state or region in which you conduct your business as a dealer.

**For safety, be sure to read this dealer's manual thoroughly before use, and follow it for correct use.**

The following instructions must be observed at all times in order to prevent personal injury and physical damage to equipment and surroundings. The instructions are classified according to the degree of danger or damage which may occur if the product is used incorrectly.



Failure to follow the instructions will result in death or serious injury.



Failure to follow the instructions could result in death or serious injury.



Failure to follow the instructions could cause personal injury or physical damage to equipment and surroundings.

## TO ENSURE SAFETY

### WARNING

- **Be sure to follow the instructions provided in the manuals when installing the product.**  
It is recommended to use genuine Shimano parts only. If parts such as bolts and nuts become loose or damaged, the bicycle may suddenly fall over, which may cause serious injury.  
In addition, if adjustments are not carried out correctly, problems may occur, and the bicycle may suddenly fall over, which may cause serious injury.
-  Be sure to wear safety glasses or goggles to protect your eyes while performing maintenance tasks such as replacing parts.
- After reading the dealer's manual thoroughly, keep it in a safe place for later reference.

### NOTE

#### **Be sure to also inform users of the following:**

- If the chain keeps coming off the gears during use, replace the gears and the chain.
- Products are not guaranteed against natural wear and deterioration from normal use and aging.
- For maximum performance we highly recommend Shimano lubricants and maintenance products.

#### **For Installation to the Bicycle, and Maintenance:**



- Always use CS-R9100/CS-R8000/CS-HG800-11 in combination with CN-9000/CN-6800/CN-HG901-11/CN-HG701-11/CN-HG601-11. Other chains cannot be used because the dimensions do not match.
- The gears should be periodically washed with a neutral detergent. In addition, cleaning the chain with neutral detergent and lubricating it can be an effective way of extending the life of the gears and the chain.
- Always use the recommended combination of gears.

The actual product may differ from the illustration because this manual is intended mainly to explain the procedures for using the product.

# LIST OF TOOLS TO BE USED

## LIST OF TOOLS TO BE USED

The following tools are needed for installation, adjustment, and maintenance purposes.

Tool		Tool	
	Adjustable wrench		TL-SR23
	TL-LR15		

# INSTALLATION

# INSTALLATION

## ■ Installing cassette sprocket

1

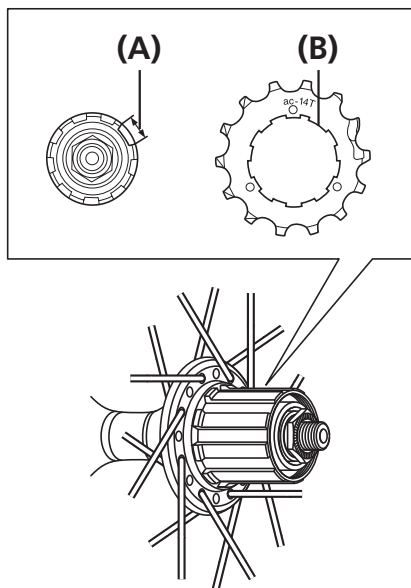

Place each sprocket with the marked side facing outward.

Install them so that the wide groove in the freewheel is aligned with the wide protrusion on each sprocket.

- (A) Wide groove (freewheel)
- (B) Wide protrusion (sprocket)

### NOTE

If installing CS-HG800-11 to a ROAD 11-speed wheel/freehub, install a 1.85mm spacer first. (A 1.85mm spacer is not required if installing to an MTB 11-speed wheel/hub.)

2

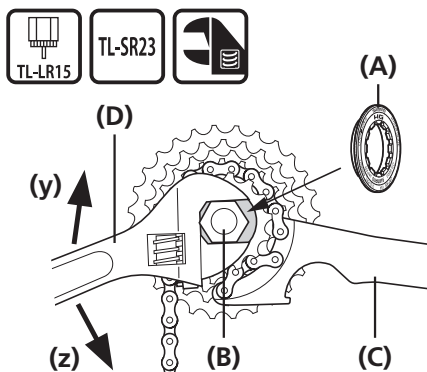

**Installing HG sprockets:**  
Tighten the lock ring with the Shimano original tool TL-LR15.

**Replacing HG sprockets:**  
Remove the lock ring with the Shimano original tools TL-LR15 and TL-SR23.

- (y) Assembly
- (z) Disassembly

- (A) Lock ring
- (B) TL-LR15
- (C) TL-SR23
- (D) Adjustable wrench

### Tightening torque



30 - 50 N·m



**CS-R9100: 11T-25T,11T-28T,11T-30T,12T-25T,12T-28T**

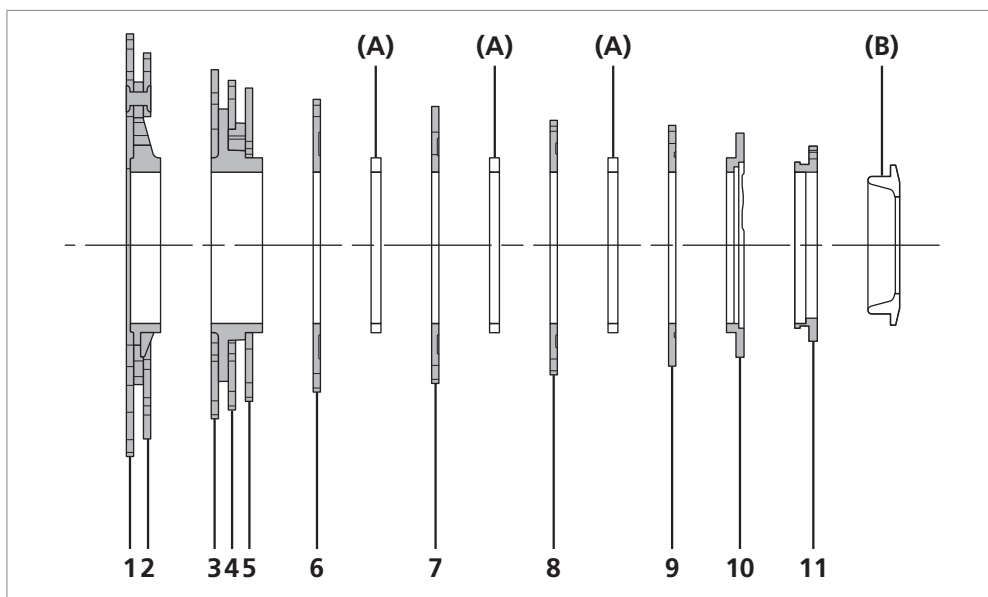

**(A)** Sprocket spacers  
**(B)** Lock ring

Number	11T-25T			11T-28T			11T-30T		
	Number of teeth	Mark	Spider arm	Number of teeth	Mark	Spider arm	Number of teeth	Mark	Spider arm
1	25	11S 25A	11S 11-25	28	11S 28A	11S 11-28	30	11S 30A	11S 11-30
2	23	11S 23B		25	11S 25B		27	11S 27A	
3	21	11S 21B	11S 11-25	23	11S 23C	11S 11-28	24	11S 24A	11S 11-30
4	19	11S 19B		21	11S 21C		21	11S 21C	
5	17	11S 17A		19	11S 19C		19	11S 19C	
6	16	11S 16A	-	17	11S 17B	-	17	11S 17B	-
7	15	11S 15A	-	15	11S 15A	-	15	11S 15A	-
8	14	11S 14A	-	14	11S 14A	-	14	11S 14A	-
9	13	11S 13A	-	13	11S 13A	-	13	11S 13A	-
10	12	11S 12A	-	12	11S 12A	-	12	11S 12A	-
11	11	11S 11A	-	11	11S 11A	-	11	11S 11A	-

Number	12T-25T			12T-28T		
	Number of teeth	Mark	Spider arm	Number of teeth	Mark	Spider arm
1	25	11S 25A	11S 12-25	28	11S 28A	11S 12-28
2	23	11S 23B		25	11S 25B	
3	21	11S 21D	11S 12-25	23	11S 23C	11S 12-28
4	19	11S 19D		21	11S 21C	
5	18	11S 18B		19	11S 19C	
6	17	11S 17C	-	17	11S 17C	-
7	16	11S 16A	-	16	11S 16A	-
8	15	11S 15A	-	15	11S 15A	-
9	14	11S 14A	-	14	11S 14A	-
10	13	11S 13B	-	13	11S 13B	-
11	12	11S 12B	-	12	11S 12B	-

**CS-R8000: 11T-25T,11T-28T,11T-30T,11T-32T,12T-25T**

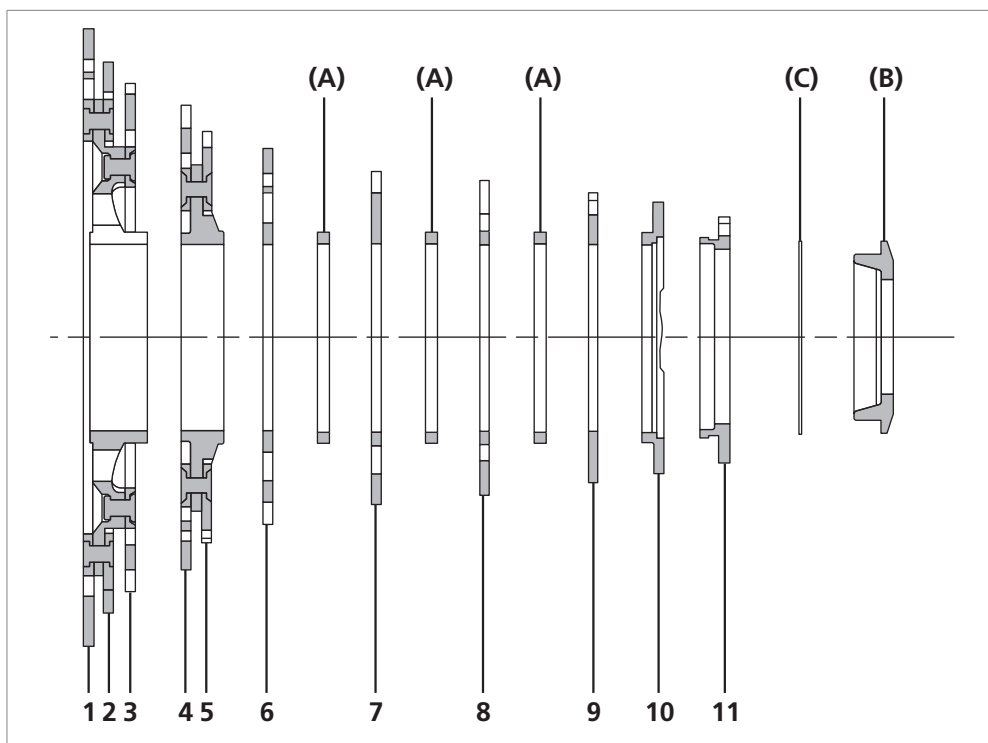

- (A)** Sprocket spacers
- (B)** Lock ring
- (C)** Spacer

Number	11T-25T (CS-R8000)			11T-28T (CS-R8000)			11T-30T (CS-R8000)		
	Number of teeth	Mark	Spider arm	Number of teeth	Mark	Spider arm	Number of teeth	Mark	Spider arm
1	25	11S 25A	11S 11-25	28	11S 28A	11S 11-28	30	11S 30A	11S 11-30
2	23	11S 23B		25	11S 25B		27	11S 27A	
3	21	11S 21B		23	11S 23C		24	11S 24A	
4	19	11S 19B	11S 11-25	21	11S 21C	11S 11-28	21	11S 21C	11S 11-30
5	17	11S 17A		19	11S 19C		19	11S 19C	
6	16	11S 16A	-	17	11S 17B	-	17	11S 17B	-
7	15	11S 15A	-	15	11S 15A	-	15	11S 15A	-
8	14	11S 14A	-	14	11S 14A	-	14	11S 14A	-
9	13	11S 13A	-	13	11S 13A	-	13	11S 13A	-
10	12	11S 12A	-	12	11S 12A	-	12	11S 12A	-
11	11	11S 11A	-	11	11S 11A	-	11	11S 11A	-

Number	11T-32T (CS-R8000)			12T-25T (CS-R8000)		
	Number of teeth	Mark	Spider arm	Number of teeth	Mark	Spider arm
1	32	11S 32A	11S 11-32	25	11S 25A	11S 12-25
2	28	11S 28B		23	11S 23B	
3	25	11S 25C		21	11S 21B	
4	22	11S 22A	11S 11-32	19	11S 19D	11S 12-25
5	20	11S 20A		18	11S 18B	
6	18	11S 18C	-	17	11S 17C	-
7	16	11S 16B	-	16	11S 16A	-
8	14	11S 14A	-	15	11S 15A	-
9	13	11S 13A	-	14	11S 14A	-
10	12	11S 12A	-	13	11S 13A	-
11	11	11S 11A	-	12	11S 12A	-

## INSTALLATION

### ▶ Installing cassette sprocket

#### CS-R8000: 14T-28T

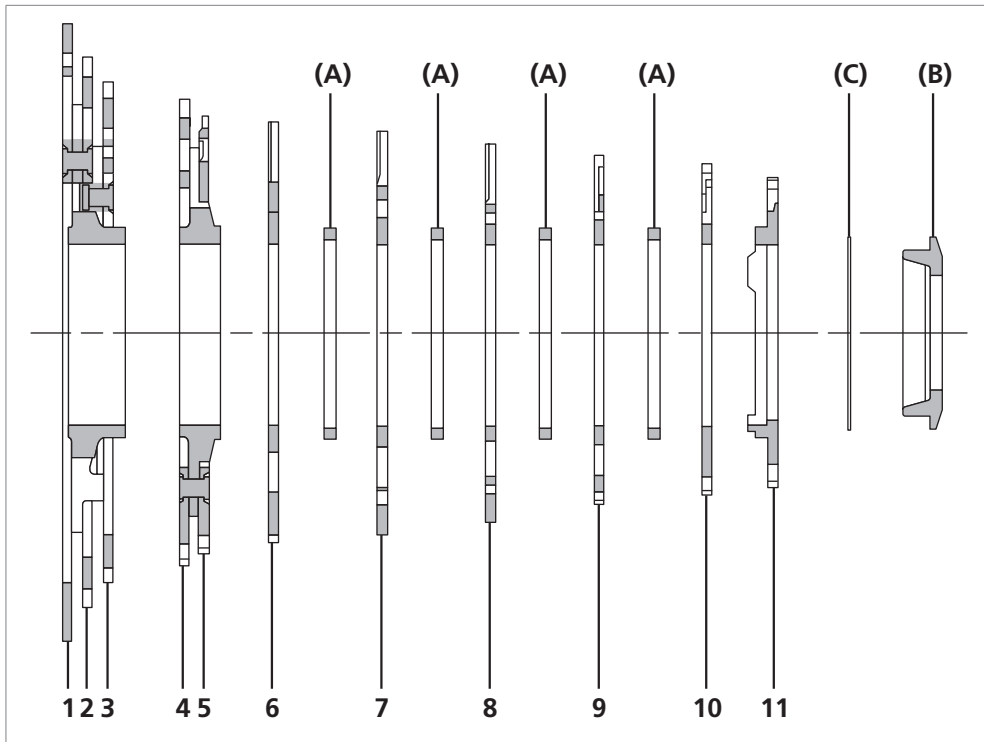

- (A)** Sprocket spacers
- (B)** Lock ring
- (C)** Spacer

14T-28T (CS-R8000)			
Number	Number of teeth	Mark	Spider arm
1	28	11S 28A	11S 14-28
2	25	11S 25B	
3	23	11S 23C	
4	21	11S 21E	11S 14-28
5	20	11S 20C	
6	19	11S 19F	-
7	18	11S 18D	-
8	17	11S 17C	-
9	16	11S 16A	-
10	15	11S 15B	-
11	14	11S 14B	-

**CS-HG800-11: 11T-34T**

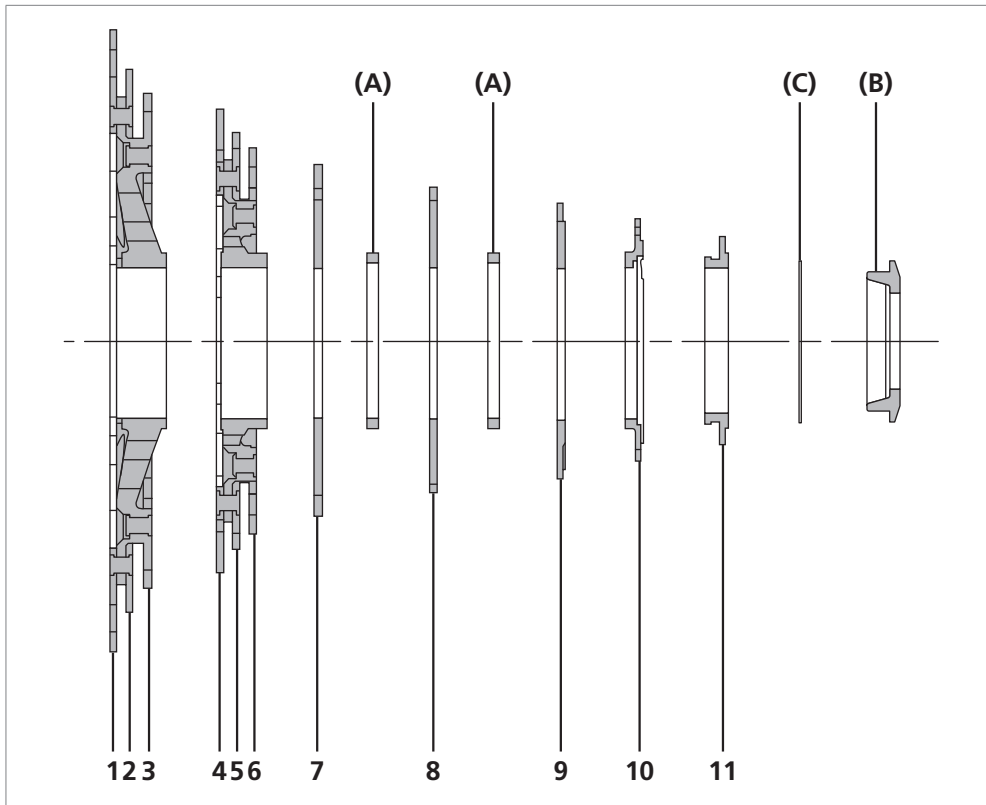

- (A)** Sprocket spacers
- (B)** Lock ring
- (C)** Spacer

11T-34T (CS-HG800-11)			
Number	Number of teeth	Mark	Spider arm
1	34	11S 34A	11S 11-34
2	30	11S 30B	
3	27	11S 27E	
4	25	11S 25D	11S 11-34
5	23	11S 23D	
6	21	11S 21J	
7	19	11S 19H	-
8	17	11S 17E	-
9	15	11S 15C	-
10	13	11S 13C	-
11	11	11S 11B	-

# SHIMANO

**SHIMANO AMERICAN CORPORATION**

One Holland, Irvine, California 92618, U.S.A. Phone: +1-949-951-5003

**SHIMANO EUROPE B.V.**

Industrieweg 24, 8071 CT Nunspeet, The Netherlands Phone: +31-341-272222

**SHIMANO INC.**

3-77 Oimatsu-cho, Sakai-ku, Sakai-shi, Osaka 590-8577, Japan

Please note: specifications are subject to change for improvement without notice. (English)

© Nov. 2016 by Shimano Inc. ITP