

## Dealer's Manual

ROAD	MTB	Trekking
City Touring/ Comfort Bike	URBAN SPORT	E-BIKE

# CASSETTE SPROCKET

## **XTR**

CS-M9100

## **DEORE XT**

CS-M8100

## **SLX**

CS-M7100

# CONTENTS

---

<b>CONTENTS</b> .....	<b>2</b>
<b>IMPORTANT NOTICE</b> .....	<b>3</b>
<b>TO ENSURE SAFETY</b> .....	<b>4</b>
<b>LIST OF TOOLS TO BE USED</b> .....	<b>6</b>
<b>INSTALLATION/REMOVAL</b> .....	<b>7</b>
Installing the cassette sprocket.....	7
Removing the cassette sprocket .....	9
Sprocket pattern .....	10
• CS-M9100 .....	10
• CS-M8100 .....	11
• CS-M7100 .....	12
<b>MAINTENANCE</b> .....	<b>13</b>
Replacing the adhesive ring .....	13
• CS-M8100/CS-M7100.....	13



# IMPORTANT NOTICE

- **This dealer's manual is intended primarily for use by professional bicycle mechanics.**  
Users who are not professionally trained for bicycle assembly should not attempt to install the components themselves using the dealer's manuals.  
If any part of the information on the manual is unclear to you, do not proceed with the installation. Instead, contact your place of purchase or a bicycle dealer for their assistance.
- Make sure to read all manuals included with the product.
- Do not disassemble or modify the product other than as stated in the information contained in this dealer's manual.
- All manuals and technical documents are accessible online at <https://si.shimano.com>.
- For consumers who do not have easy access to the internet, please contact a SHIMANO distributor or any of the SHIMANO offices to obtain a hardcopy of the User's Manual.
- Please observe the appropriate rules and regulations of the country, state or region in which you conduct your business as a dealer.

**For safety, be sure to read this dealer's manual thoroughly before use, and follow it for correct use.**

The following instructions must be observed at all times in order to prevent personal injury and physical damage to equipment and surroundings.

The instructions are classified according to the degree of danger or damage which may occur if the product is used incorrectly.

 <b>DANGER</b>	Failure to follow the instructions will result in death or serious injury.
 <b>WARNING</b>	Failure to follow the instructions could result in death or serious injury.
 <b>CAUTION</b>	Failure to follow the instructions could cause personal injury or physical damage to equipment and surroundings.

# TO ENSURE SAFETY

## ⚠ WARNING

- Be sure to follow the instructions provided in the manuals when installing the product. Only use SHIMANO genuine parts. If a component or replacement part is incorrectly assembled or adjusted, it can lead to component failure and cause the rider to lose control and crash.
- If the lock ring is tightened with the sprockets improperly positioned, the splines on the sprockets may be damaged during tightening. That may cause a sudden release of resistance on the wrench being used to tighten the lock ring, which in turn may cause injury. In addition, if the bike is ridden with the sprockets improperly installed, damage or chain skip may occur, which can cause the rider to crash, resulting in serious injury.

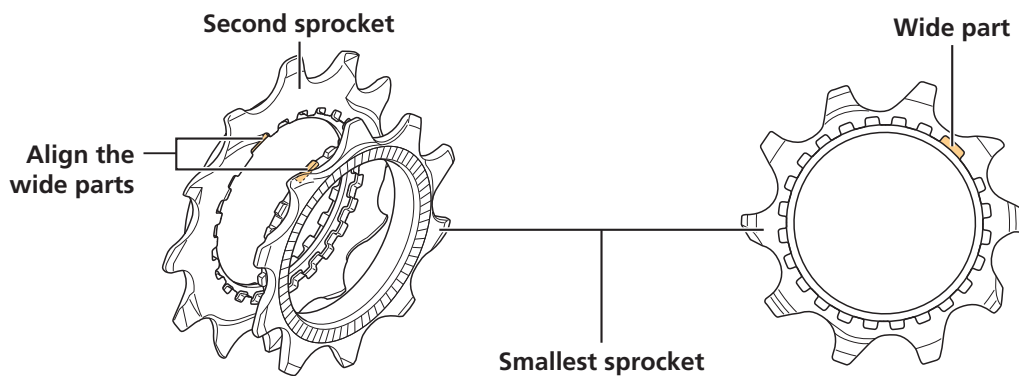

Properly positioned state

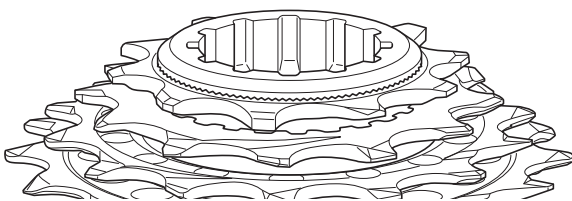

The protrusions on the smallest sprocket fit into the indents in the second sprocket along the entire circumference.

Improperly positioned state

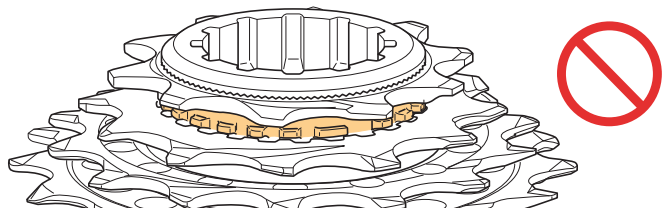

There are places where the protrusions on the smallest sprocket overlap the indents in the second sprocket.

-  Wear approved eye protection while performing maintenance tasks such as replacing components.

## **NOTICE**

### **Be sure to also inform users of the following:**

- If the chain keeps skipping during use, consult the place of purchase.
- Products are not guaranteed against natural wear and deterioration from normal use and aging.
- For maximum performance we highly recommend SHIMANO lubricants and maintenance products.

### **For installation to the bicycle, and maintenance:**





- The gears should be periodically washed with a neutral detergent. In addition, cleaning the chain with neutral detergent and lubricating it can be an effective way of extending the life of the gears and the chain.
- Always use the recommended combination of gears.
- Always use CS-M9100/CS-M8100/CS-M7100 in combination with CN-M9100/CN-M8100/CN-M7100.

Other chains cannot be used because the dimensions do not match.

The actual product may differ from the illustration because this manual is intended mainly to explain the procedures for using the product.

# LIST OF TOOLS TO BE USED

The following tools are needed for installation/removal, adjustment, and maintenance purposes.

Tool	
	TL-LR10
	TL-LR15
	TL-SR24
	Adjustable wrench

# INSTALLATION/REMOVAL

## Installing the cassette sprocket

### 1. Place all of the sprockets other than the smallest sprocket on the freewheel body.

For CS-M9100, place the low spacer first.

Then, place the sprockets in descending order from the largest sprocket.

Place the sprockets so that the wide convex section of the sprocket is aligned with the wide groove in the freewheel body.

The marked side of the sprockets must be facing outward.

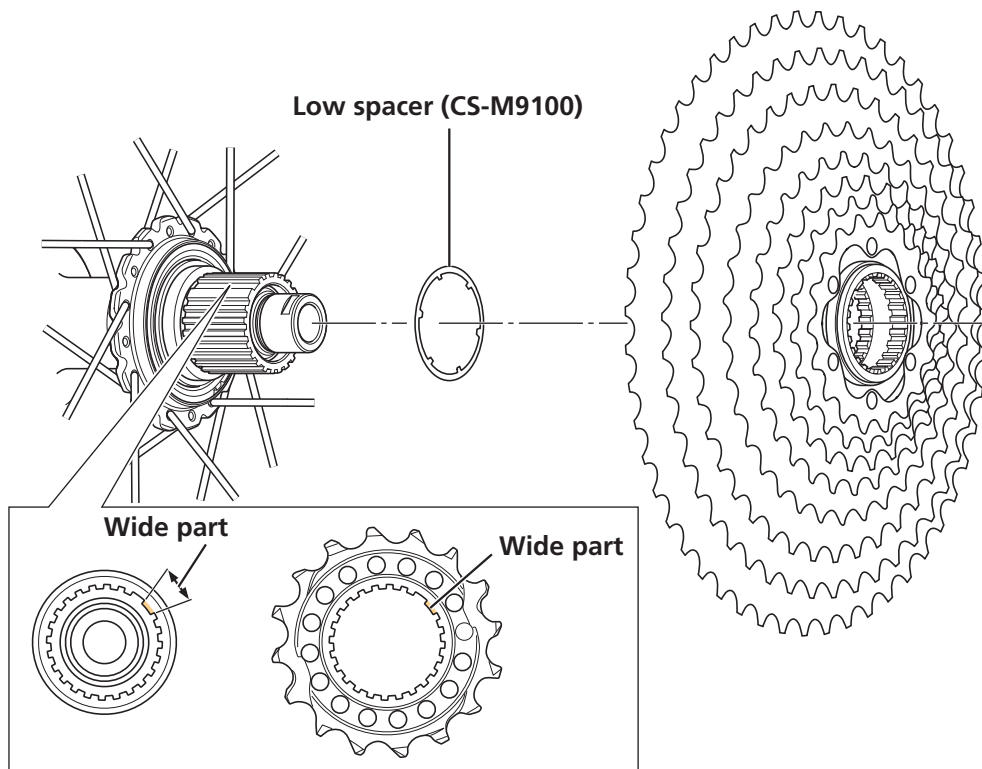

### NOTICE

- Do not stack more than 2 low spacers.

## 2. Place the smallest sprocket.

Place the sprocket so that the wide part on the inner side of the smallest sprocket is aligned with the wide part of the second sprocket.

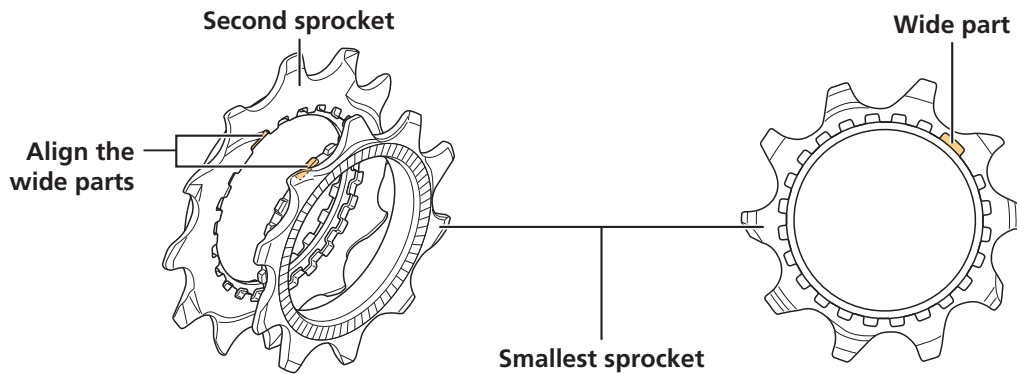

### TECH TIPS

- There are sprocket alignment marks for 10T (smallest sprocket), 12T, and 14T. Assemble it so that the marks of each sprocket are aligned.

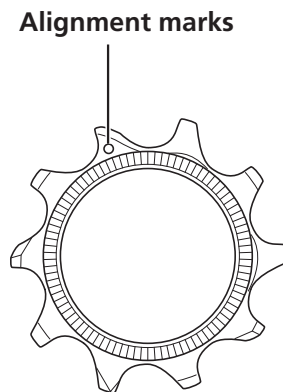

- If the sprocket aligning marks are properly placed, it will be as shown in the figure.

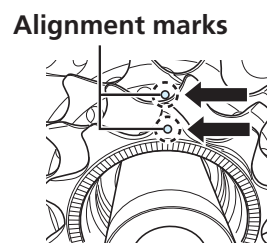



- Place the lock ring into the freehub body and use a SHIMANO original tool to tighten.

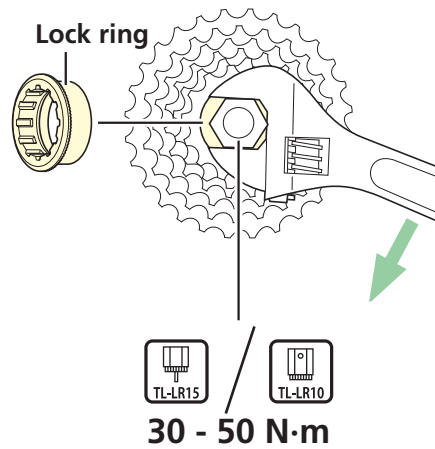

## Removing the cassette sprocket

- Remove the lock ring with a SHIMANO original tool.

Install TL-SR24 on the sprocket outward from the middle sprocket to secure the assembly. If the TL-SR24 is set on a sprocket inward from the middle sprocket, it will not be stable.

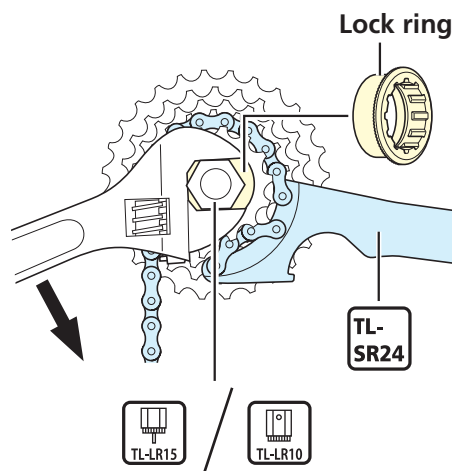

- Remove the cassette sprocket from the freehub body.

# Sprocket pattern

## CS-M9100

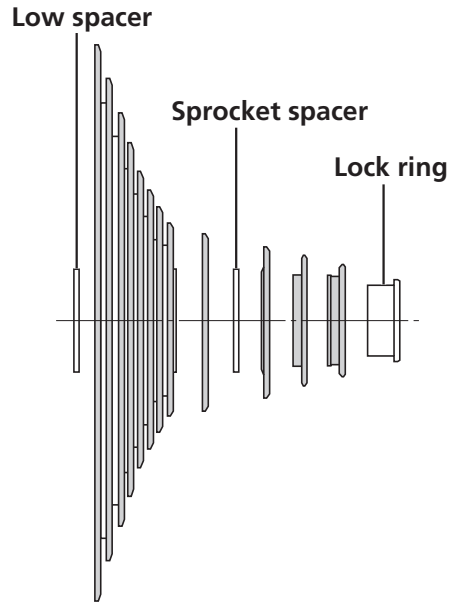

Number	10 - 51T		10 - 45T		
	Number of teeth	Mark	Number of teeth	Mark	
1	51	51A	45	45C	
2	45	45A	40	40C	
3	39	39A	36	36A	
4	33	33A	32	32C	
5	28	28E	28	28E	
6	24	24E	24	24E	
7	21	21L	21	21L	
8	18	18E	18	18E	
9	16	16C	16	16C	
10	14	14C	14	14C	
11	12	12C	12	12C	12D
12	10	10A	10	10A	10B

# CS-M8100

The thickness of the two sprocket spacers differs. Be careful when installing the sprocket spacers.

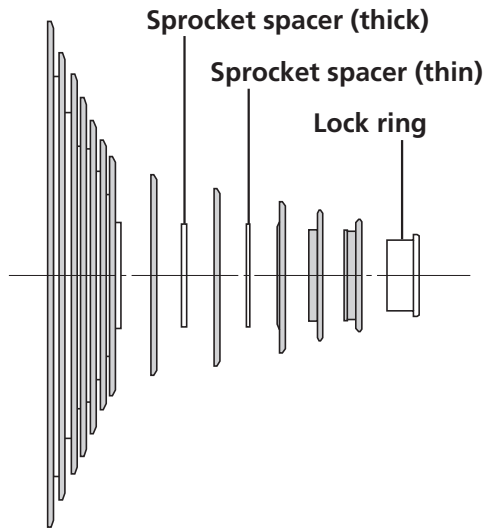

Number	10 - 51T		10 - 45T	
	Number of teeth	Mark	Number of teeth	Mark
1	51	51B	45	45F
2	45	45D	40	40D
3	39	39B	36	36B
4	33	33B	32	32D
5	28	28F	28	28F
6	24	24F	24	24F
7	21	21M	21	21M
8	18	18F	18	18F
9	16	16C	16	16C
10	14	14C	14	14C
11	12	12D	12	12D
12	10	10B	10	10B

# CS-M7100

The thickness of the two sprocket spacers differs. Be careful when installing the sprocket spacers.

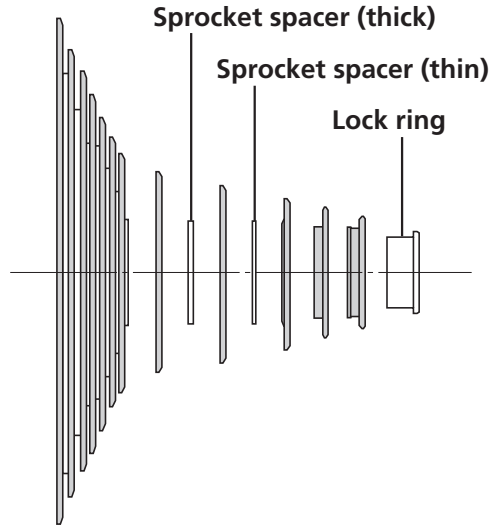

Number	10 - 51T		10 - 45T	
	Number of teeth	Mark	Number of teeth	Mark
1	51	51B	45	45F
2	45	45E	40	40E
3	39	39B	36	36B
4	33	33B	32	32D
5	28	28F	28	28F
6	24	24F	24	24F
7	21	21M	21	21M
8	18	18F	18	18F
9	16	16C	16	16C
10	14	14C	14	14C
11	12	12D	12	12D
12	10	10B	10	10B

# MAINTENANCE

## Replacing the adhesive ring

CS-M8100/CS-M7100

### 1. Remove the old adhesive ring.

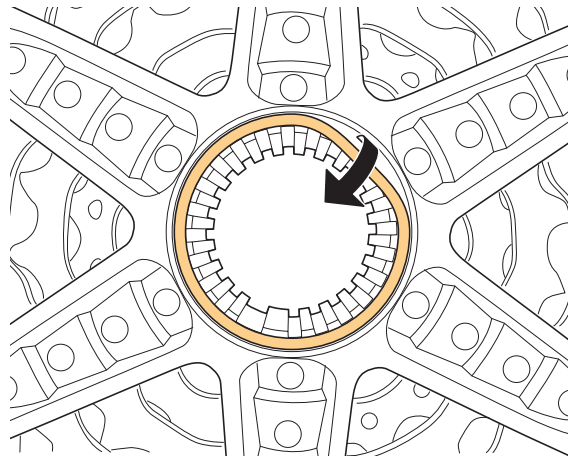

### 2. Wipe clean any dirt, water, and oil on the surface where the adhesive ring was affixed.

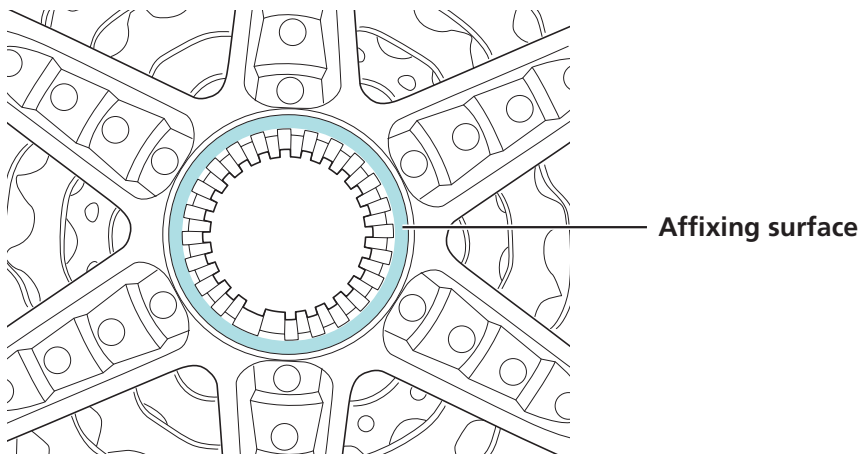

#### **NOTICE**

- The adhesive force weakens if there is any dirt, water, or oil on the surface where the adhesive ring was affixed.

### 3. Affix a new adhesive ring.

Firmly press down on the adhesive ring so that it adheres firmly to the mating face of the cassette.

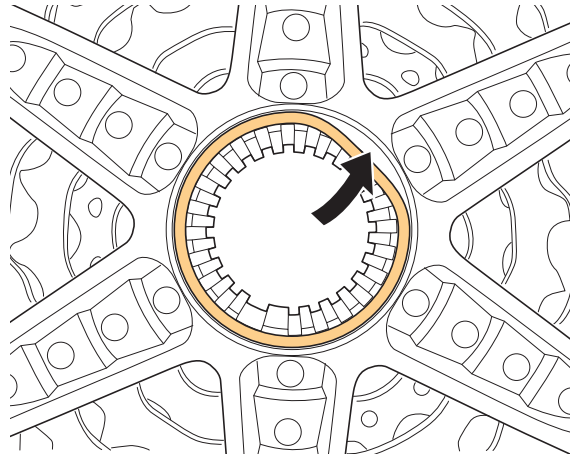

# SHIMANO

**SHIMANO NORTH AMERICA BICYCLE, INC.**

One Holland, Irvine, California 92618, U.S.A. Phone: +1-949-951-5003

**SHIMANO EUROPE B.V.**

High Tech Campus 92, 5656 AG Eindhoven, The Netherlands Phone: +31-402-612222

**SHIMANO INC.**

3-77 Oimatsu-cho, Sakai-ku, Sakai City, Osaka 590-8577, Japan

Please note: specifications are subject to change for improvement without notice. (English)

© Jul. 2019 by SHIMANO INC. ITP