



One-Sided SPD / One-Sided Flat Pedals

IMPORTANT NOTICE

• Contact the place of purchase or a distributor for information on installation, adjustment, and replacement of the products which are not found in the user's manual. A dealer's manual for professional and experienced bicycle mechanics is available on our website (<https://si.shimano.com>).

For safety, be sure to read this "user's manual" thoroughly before use, follow it for correct use, and store it so that it can be referenced at any time.

The following instructions must be observed at all times in order to prevent personal injury and physical damage to equipment and surroundings. The instructions are classified according to the degree of danger or damage which may occur if the product is used incorrectly.

DANGER	Failure to follow the instructions will result in death or serious injury.
WARNING	Failure to follow the instructions could result in death or serious injury.
CAUTION	Failure to follow the instructions could cause personal injury or physical damage to equipment and surroundings.

Important safety information

WARNING

- In order to ensure child safety for children using this product, children should be given instruction on the correct use after both guardians and children have fully understood the following information. Failure to follow the provided instructions may lead to serious injury.
- Do not disassemble or modify the product. This may cause the product to not operate correctly, and you may suddenly fall and be seriously injured.
- Before attempting to ride with these pedals and cleats (shoes), make sure you understand the operation of the engagement/release mechanism for the pedals and cleats (shoes). SPD pedals are designed to be released only when intended. They are not designed to be released automatically when you have fallen off the bicycle.
- Use only SPD shoes with this product. Other types of shoes may not release from the pedals, or may release unexpectedly.
- Use only SHIMANO cleats (SM-SH51/SM-SH56) and make sure that the mounting screws are tightened securely to the shoes. Failure to securely tighten the screws may result in a fall in which the cleats do not release.
- Before attempting to ride with these pedals and cleats, apply the brakes, then place one foot on the ground and practice engaging and releasing each cleat from its pedal until you can do so naturally and with minimal effort.
- Ride on level ground first until you become accustomed to engaging and releasing your cleats from the pedals.
- Before riding, adjust the cleat holding force of the pedals to your liking. If the cleat holding force of the pedals is low, the cleats may become accidentally released and you may lose balance and fall off the bicycle. If the cleat holding force of the pedals is high, the cleats cannot be easily released.

- When riding at low speed or when there is a possibility that you might need to stop riding, (for example, when doing a U-turn, nearing an intersection, riding uphill or turning a blind curve), release your cleats from the pedals beforehand so that you can quickly put your feet onto the ground at any time.
- Use a lighter cleat holding force for attaching the pedal cleats when riding in adverse conditions.
- Keep cleats and bindings out of dirt and debris to ensure proper engagement and release.
- Remember to check the cleats periodically for wear. When the cleats are worn, replace them, and adjust the cleat holding force before riding and after replacing the pedal cleats.

If the warnings above are not followed, your shoes may not come out of the pedals when you intend or they may come out unexpectedly or accidentally, and severe injury may result.

- If you are unsure of how to replace the short and long pins on the pedals, contact the place of purchase or a distributor.
- Raise your feet from the pedals then slide them sideways to disengage your feet from the pedals. With one foot firmly on the ground, practice engaging and disengaging the other foot from the pedal repeatedly until you become used to the operation, otherwise, you may fall and be seriously injured. If you cannot get used to this operation, use the product with spacers installed or the short pins replaced.
- Be sure to wear clothing and protective gear which is suitable for the way in which the bicycle is to be used. Because the pins are long, they may cause injury if they come into direct contact with your skin.
- Do not continue riding the bicycle if the reflectors are dirty or damaged. Otherwise, it becomes more difficult for oncoming vehicles to see you.
- Do not use the pedals or cleats in any way not described in the user's manual. When the cleat and pedal are facing forwards, the cleat can be released and engaged with the pedal. Read the user's manual carefully for instructions on using the cleats. Failure to follow the instructions may lead to serious injury.

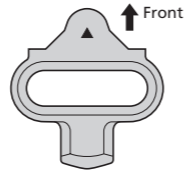

- Read the manual and choose the correct product for your needs, based on a consideration of bicycle type, riding terrain, and conditions. Single release mode cleats (SM-SH51) and multiple release mode cleats (SM-SH56) are available for use with these pedals. Cleats such as the single release mode cleats (SM-SH52) and multiple release mode cleats (SM-SH55) cannot be used as they lack certain features, such as stable step-out performance and sufficient holding force. If such cleats are used, the shoes may not come out of the pedals when you intend or they may come out unexpectedly or accidentally, resulting in the bicycle collapsing and serious injury.

Notice

- If pedaling performance does not feel normal, perform an inspection again.
- If you experience any trouble with the rotating parts of the pedal, the pedal may require adjustment. Consult your place of purchase or a distributor.
- Products are not guaranteed against natural wear and deterioration from normal use and aging.
- For maximum performance we highly recommend SHIMANO lubricants and maintenance products.

Regular inspections before riding the bicycle

Before riding the bicycle, check the following items. If any problems are found, consult your place of purchase or a distributor.

- Are the fastening sections fixed securely?
- Has excess play increased between the cleat and pedal due to wear?
- Are there any abnormalities when the cleat engages or releases?
- Are there any abnormal noises?

Names of parts

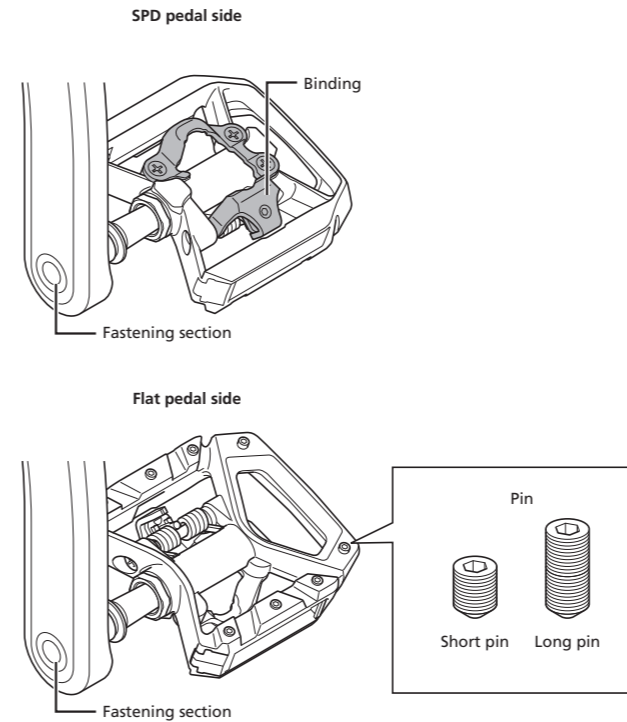

Cleat types, and using the cleats

■ How to engage

Press the cleats into the pedal binding with an angled downward motion.

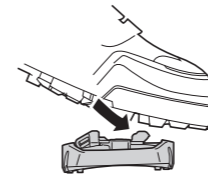

■ How to release

The release mode can be selected depending on the type of cleat being used.

(Check the cleat model number and color for the appropriate release method.)

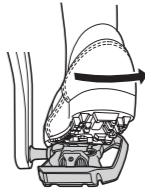
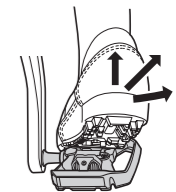
Single release mode cleats: SM-SH51 (Black)	Multiple release mode cleats: SM-SH56 (Silver, Gold / sold separately)
These cleats only release when the heel is moved outward. They will not release if the heel is twisted in any other direction. 	The cleats can be released by twisting in any direction. 
Upward force may be applied to the pedal, since the cleat will not release unless the foot is twisted.	The cleat may release in an upward direction. Therefore, pulling up on the pedal may result in the cleat unexpectedly disengaging. Therefore, do not use this cleat if you pull up on the pedals when riding, or if you perform jumps or similar in which forces act on the foot in the direction of cleat release.
The cleats will not necessarily release if you lose your balance. Accordingly, for places and conditions where it looks as though you may lose balance, make sure that you have sufficient time to release the cleats beforehand.	Although the cleats do release in directions other than the horizontal, they will not necessarily release if you lose your balance. Accordingly, for places and conditions where it looks as though you may lose balance, make sure that you have sufficient time to release the cleats beforehand.
When, for example, you are pedaling vigorously, your heel may inadvertently twist sideways and this may cause the cleat to release accidentally. Once you have adjusted the cleats, practice engaging and releasing until you are fully familiar with the amount of force and foot angle required. An unexpected release may cause you to fall off the bicycle and serious injury may result.	If the characteristics of multiple release mode cleats are not sufficiently understood or used correctly, they are more likely than single release mode cleats to release unexpectedly. Once you have adjusted the cleats, practice engaging and releasing until you are fully familiar with the amount of force required in each direction. An unexpected release may cause you to fall off the bicycle and serious injury may result.

Notice

It is necessary to practice releasing until you become accustomed to the technique.

- * In multiple release mode, releasing by lifting your heel requires particular practice.

Adjusting the cleat holding force of the pedals

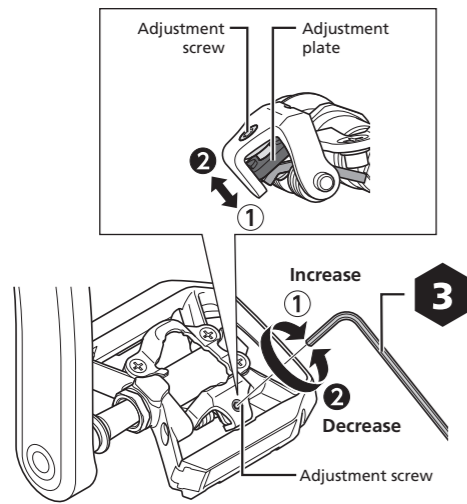

- The spring tension of the pedals can be adjusted by turning the adjustment screw.
- Clicking the adjustment screw once changes the tension one step. There are four clicks per turn.
- The adjustment screw is located at the rear of each binding, resulting in two positions in total for the two pedals.
- Adjust the spring force to the optimal cleat holding force when releasing the cleats from the bindings.
- Equalize the cleat holding forces at the two positions by checking the adjustment plate position and counting the number of turns of the adjustment screws.
- Turning the adjustment screw clockwise increases the cleat holding force, and turning it counterclockwise decreases it.

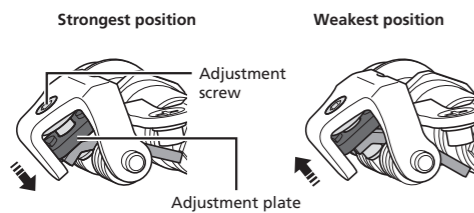

If the adjustment plate is at the strongest or the weakest position, do not turn the adjustment screw any further.

Notice

- In order to prevent accidental cleat release and ensure that release is possible when needed, make sure that the cleat holding force is properly adjusted.
- If the cleats are not adjusted equally, it can cause the rider difficulty in engaging or releasing the cleats. The cleat holding force for the right and left pedals should be adjusted so they are equal.

Replacing cleats, replacing body covers

Cleats and body covers become worn and need to be replaced periodically.

When, due to wear, the cleat release starts to become too tight or too loose, immediately contact the place of purchase or a distributor and replace the cleats and body covers with new ones.

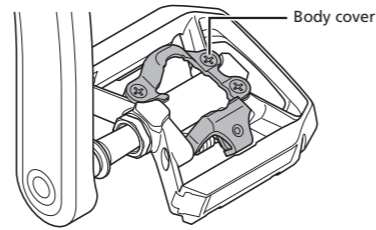

SHIMANO

SHIMANO NORTH AMERICA BICYCLE, INC.
One Holland, Irvine, California 92618, U.S.A. Phone: +1-949-951-5003

SHIMANO EUROPE B.V.
High Tech Campus 92, 5656 AG Eindhoven, The Netherlands Phone: +31-402-612222

SHIMANO INC.
3-77 Oimatsu-cho, Sakai-ku, Sakai City, Osaka 590-8577, Japan

Please note: specifications are subject to change for improvement without notice. (English)
© Dec. 2020 by SHIMANO INC. ITP