



Disc Brake Rotor Adapter

IMPORTANT NOTICE

- Contact the place of purchase or a distributor for information on installation, adjustment, and replacement of the products which are not found in the user's manual. A dealer's manual for professional and experienced bicycle mechanics is available on our website (<https://si.shimano.com>).

For safety, be sure to read this "user's manual" thoroughly before use, follow it for correct use, and store it so that it can be referenced at any time.

The following instructions must be observed at all times in order to prevent personal injury and physical damage to equipment and surroundings. The instructions are classified according to the degree of danger or damage which may occur if the product is used incorrectly.

DANGER	Failure to follow the instructions will result in death or serious injury.
WARNING	Failure to follow the instructions could result in death or serious injury.
CAUTION	Failure to follow the instructions could cause personal injury or physical damage to equipment and surroundings.

Important safety information

WARNING

- Because each bicycle may handle slightly differently depending on the model, be sure to learn the proper braking technique (including brake lever pressure and bicycle control characteristics) and operation of your bicycle. Improper use of your bicycle's brake system may result in a loss of control, which could lead to serious injury due to a fall or collision.
- Do not disassemble or modify the product. This may cause the product to not operate correctly, and you may suddenly fall and be seriously injured.
- Riders must become accustomed to the higher performance of this brake before riding the bicycle. The 203 mm and 180 mm disc brake rotors provide a higher braking force than the 160 mm disc brake rotors. If you ride the bicycle without becoming sufficiently familiar with the braking characteristics, braking may cause you to fall off the bicycle, potentially causing serious injury or a fatal accident.



- Please use extra caution to keep your fingers away from the rotating disc brake rotor. The disc brake rotor is sharp enough to inflict severe injury to your fingers if caught within the openings of moving rotor.
- Do not touch the calipers or disc brake rotor while riding or immediately after dismounting from the bicycle. The calipers and disc brake rotor will become hot when the brakes are operated, so you may get burned if you touch them.
- Do not allow any oil or grease to get onto the disc brake rotor and brake pads. Riding the bicycle with oil or grease on the brake shoes may prevent the brakes from operating and result in serious injury due to a fall or collision.

- Check the thickness of the brake pads and do not use them if they have a thickness of 0.5 mm or less. Doing so may prevent the brakes from operating and result in serious injury due to a fall or collision.

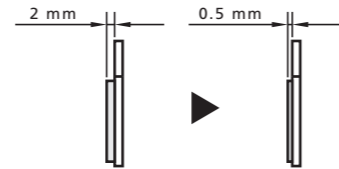

- Do not use the disc brake rotor if it is cracked or deformed. The disc brake rotor may break, and result in serious injury due to a fall. Replace the disc brake rotor with a new one.
- Do not use the disc brake rotor if its thickness is 1.5 mm or less. Also do not use it if the aluminum surface becomes visible. The disc brake rotor may break, and result in serious injury due to a fall. Replace the disc brake rotor with a new one.
- Do not apply the front brake too strongly. If you do so, the front wheel may lock and the bicycle may fall forward, and serious injury may result.
- Because the required braking distance will be longer during wet weather, reduce your speed and apply the brakes early and gently. You may fall or collide and be seriously injured.
- A wet road surface may cause tires to lose traction; therefore, to avoid this, reduce your speed and apply the brakes early and gently. If the tires lose traction, you may fall and be seriously injured.

Warnings regarding hydraulic disc brakes

- Do not continuously apply the brakes. Doing so may cause a sudden increase in the brake lever stroke, preventing the brakes from operating and resulting in serious injury due to a fall or collision.
- Do not use the brakes with fluid leaking. Doing so may prevent the brakes from operating and result in serious injury due to a fall or collision.

Warnings regarding mechanical disc brakes

- Do not use the brake cable if it has any rust, fraying, or cracks. Doing so may prevent the brakes from operating and result in serious injury due to a fall or collision.

CAUTION

- Disc brakes have a bed-in period, and the braking force will gradually increase as the bed-in period progresses. Accidents or falls may occur due to losing control of the bicycle, possibly resulting in serious injury. The same thing will happen when the brake pads or disc brake rotor are replaced.

Notice

- To prevent noise and ensure the best performance, perform the bed-in procedure after replacing the brake pads or disc brake rotor.
- Also, read carefully all manuals included with the brake lever and brake caliper.
- Products are not guaranteed against natural wear and deterioration from normal use and aging.
- For maximum performance we highly recommend SHIMANO lubricants and maintenance products.

Descriptions regarding hydraulic disc brakes

- When the bicycle wheel has been removed, it is recommended that pad spacers are installed. Do not depress the brake lever while the wheel is removed. If the brake lever is depressed without the pad spacers installed, the pistons will protrude further than normal. If that happens, consult a place of purchase.

Regular inspections before riding the bicycle

Before riding the bicycle, check the following items. If any problems are found, consult your place of purchase or a distributor.

- Do the front and rear brakes work correctly?
- Is the gap in the brake lever sufficient?
- Does the brake cable have any rust, fraying, or cracks?
- Do the brake pads have a thickness of 0.5 mm or more?
- Is the disc brake rotor cracked or deformed?
- Are there any abnormal noises?

Names of parts

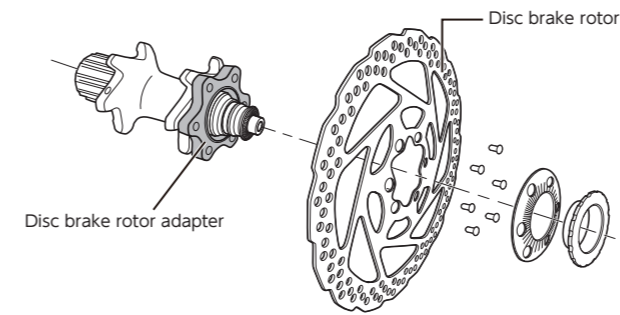

Hydraulic disc brake

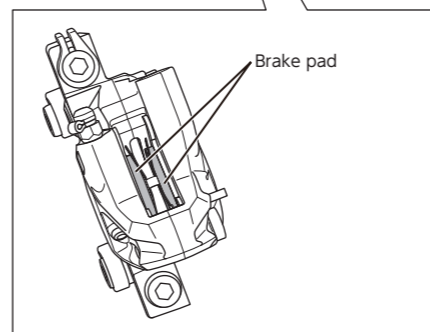
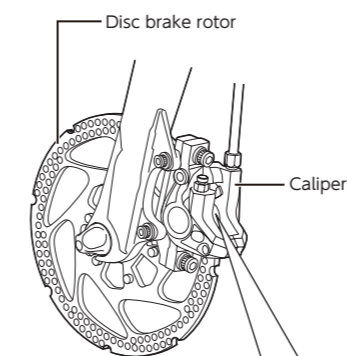
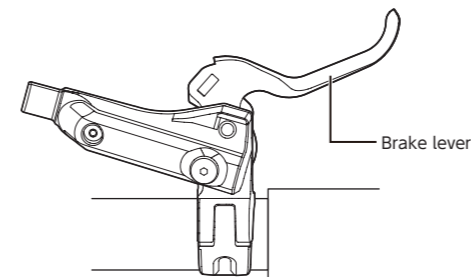

Mechanical disc brake

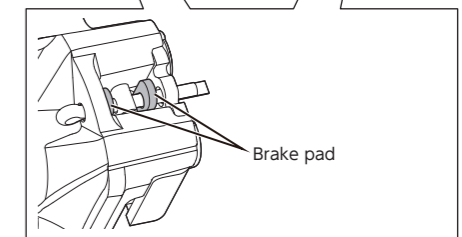
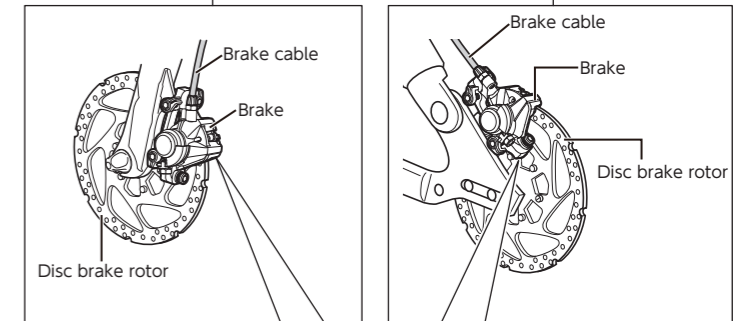
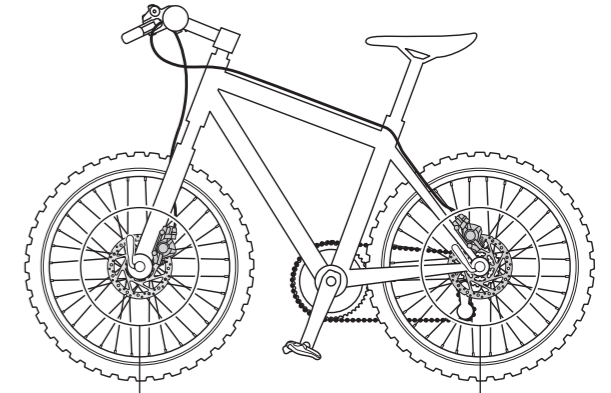

How to perform bed-in

To optimize the performance of the brake pads and disc brake rotor, perform the bed-in procedure as explained in the steps below:

- Ride your bicycle in a flat and safe area without obstacles and accelerate to a moderate speed.
- Operate the brake lever until you slow down to walking speed. Do this only with one brake lever at a time. Be careful when performing this procedure. Always operate your brake lever with moderation, especially when you bed in the front brake.
- Repeat steps 1 and 2 for at least 20 times for both the front and rear brakes. While repeating the process, the brake force will increase.

SHIMANO

SHIMANO NORTH AMERICA BICYCLE, INC.
One Holland, Irvine, California 92618, U.S.A. Phone: +1-949-951-5003

SHIMANO EUROPE B.V.
High Tech Campus 92, 5656 AG Eindhoven, The Netherlands Phone: +31-402-612222

SHIMANO INC.
3-77 Oimatsu-cho, Sakai-ku, Sakai City, Osaka 590-8577, Japan