

SHIMANO STEPS

SHIMANO Total Electric Power System

User's Manual for Drop Handlebar Bicycles

This user's manual is for SHIMANO STEPS drop handlebar bicycles.

It describes configurations for drop handlebar type bicycles, how to operate the dual control lever, and other information.

Refer to the user's manual for your series for details on **how to handle the battery, and on settings for assist mode and the cycle computer.**

User's manuals for each series can be seen at the following link:

<http://si.shimano.com>

CONTENTS

IMPORTANT NOTICE	2
Important safety information	2
To ensure safety	2
User's Manuals.....	6
User's Manual for Drop Handlebar Bicycles (this document)	6
SHIMANO STEPS user's manuals for each series	6
Assist Mode.....	6
Quick guide	7
Names of parts.....	10
Operation	11
Basic operation.....	11

IMPORTANT NOTICE

- Contact the place of purchase or a bicycle dealer for information on installation and adjustment of the products which are not found in the user's manual. A dealer's manual for professional and experienced bicycle mechanics is available on our website (<http://si.shimano.com>).
- Do not disassemble or alter this product.
- Use the product according to local laws and regulations.
- The Bluetooth® word mark and logos are registered trademarks owned by the Bluetooth SIG, Inc. and any use of such marks by SHIMANO INC. is under license. Other trademarks and trade names are those of their respective owners.

For safety, be sure to read this user's manual thoroughly before use, and follow it for correct use.

Important safety information

- Please keep the User's Manual for future reference.
- Be sure to observe the following in order to avoid burns or other injury from fluid leakages, overheating, fire or explosions.

To ensure safety



Handling the battery

- Do not deform, modify, disassemble or apply solder directly to the battery. Doing so may cause leakage, overheating, bursting, or ignition of the battery.
- Do not leave the battery near sources of heat such as heaters. Doing so may cause bursting or ignition of the battery.
- Do not heat the battery or throw it into a fire. Doing so may cause bursting or ignition of the battery.
- Do not subject the battery to strong shocks or throw it. If this is not observed, overheating, bursting, or fire may occur.
- Do not place the battery into fresh water or sea water, and do not allow the battery terminals to get wet. Doing so may cause overheating, bursting, or ignition of the battery.
- Use the SHIMANO specified charger and observe the specified charging conditions when charging the specified battery. Not doing so may cause overheating, bursting, or ignition of the battery.



To ensure safe riding

- Do not give too much of your attention to the cycle computer display while riding, otherwise accidents may result.
- Check that the wheels are securely installed to the bicycle before commencing riding. If the wheels are not securely installed, the bicycle may fall over and cause serious injury.
- If riding a power-assisted bicycle, make sure that you are fully familiar with the starting-off characteristics of the bicycle before riding it on roads with several vehicle lanes and pedestrian footpaths. If the bicycle starts off suddenly, accidents may result.
- Check that the bicycle lights illuminate before riding at night.

Using the product safely

- Be sure to remove the battery and charging cable before wiring or attaching parts to the bicycle. Otherwise, an electric shock may result.
- When charging the battery while it is installed on the bicycle, do not move the bicycle. The power plug for the battery charger may come loose and not be fully inserted into the electrical outlet, resulting in risk of fire.
- Do not touch the drive unit when it has been continuously used for a long period of time. The surface of the drive unit becomes hot and could cause burns.
- Periodically clean the chain using an appropriate chain cleaner. The frequency of maintenance will vary depending on the riding conditions.
- Do not use alkaline or acidic cleaning agents for removing rust under any circumstances. If such cleaning agents are used, they may damage the chain and serious injury may result.
- When installing this product, be sure to follow the instructions given in the user's manual. Furthermore, it is recommended that you use only genuine SHIMANO parts at these times. If bolts and nuts are left loosened or the product is damaged, the bicycle may suddenly fall over and serious injury may result.

Handling the battery

- If any liquid leaking from the battery gets into your eyes, immediately wash the affected area thoroughly with clean water such as tap water without rubbing your eyes, and seek medical advice immediately. If this is not done, the battery liquid may damage your eyes.
- Do not recharge the battery in places with high humidity or outdoors. Doing so may result in electric shock.
- Do not insert or remove the plug while it is wet. If this is not observed, electric shocks may result. If there is water leaking out of the plug, dry it thoroughly before inserting it.
- If the battery does not become fully charged after 2 hours of charging, immediately unplug the battery from the outlet and contact the place of purchase. Doing otherwise may cause overheating, bursting, or ignition of the battery. Refer to the battery charger user's manual for the designated charging time of the battery.
- Do not use the battery if it has any noticeable scratches or other external damage. Doing so may cause bursting, overheating or problems with operation.
- The operating temperature ranges for the battery are given below. Do not use the battery in temperatures outside these ranges. If the battery is used or stored in temperatures outside these ranges, fire, injury or problems with operation may occur.
 1. During discharge: -10°C - 50°C
 2. During charging: 0°C - 40°C



To ensure safe riding

- Observe the instructions in the user's manual for the bicycle, in order to ride safely.

Using the product safely

- Never attempt to modify the system yourself. It may cause problems with system operation.
- Periodically check the battery charger and adapter, particularly the cord, plug, and case, for any damage. If the charger or adapter is broken, do not use it until it has been repaired.
- This appliance is not intended for use by persons (including children) with reduced physical, sensory or mental capabilities, or lack of experience and knowledge, unless they have been given supervision or instruction concerning use of the appliance by a person responsible for their safety.
- Do not allow children to play near the product.

Handling the battery

- Do not leave the battery in a place exposed to direct sunlight, inside a vehicle on a hot day, or other hot places. This may result in battery leakage.
- If any leaked fluid gets on your skin or clothes, wash it off immediately with clean water. The leaked fluid may damage your skin.
- Store the battery in a safe place out of the reach of infants and pets.

NOTICE

Using the product safely

- If any malfunctions or other problems occur, contact the place of purchase.
- Be sure to install caps to any connectors which are not being used.
- For installation and adjustment of the product, consult a dealer.
- The Product is designed to be fully waterproof to withstand wet weather riding conditions. However, do not deliberately place them into water.
- Do not clean the bicycle in a high-pressure wash. If water gets into any of the components, operating problems or rusting may result.
- Do not turn the bicycle upside down. The cycle computer or the shifting switch may get damaged.
- Handle the product carefully, and avoid subjecting it to any strong shocks.
- Although the bicycle still functions as a normal bicycle even when the battery is removed, the light does not turn on if it is connected to the electric power system. Be aware that using the bicycle under these conditions will be considered non-observance of the road traffic laws in Germany.
- When charging the battery while it is mounted on the bicycle, be careful of the following:
 - When charging, make sure there is no water on the charging port or the charger plug.
 - Ensure that the battery is locked into the battery mount before charging.
 - Do not remove the battery from the battery mount while charging.
 - Do not ride with the charger mounted.
 - Close the charging port cap when not charging.
 - Stabilize the bicycle to ensure that it does not collapse during charging.

Handling the battery

- When you carry a power-assisted bicycle in a car, remove the battery from the bicycle and place the bicycle on a stable surface in the car.
- Before connecting the battery, make sure that there is no buildup of water or dirt in the connector where the battery will be connected.
- The use of a genuine SHIMANO battery is recommended. If using a battery from another manufacturer, make sure to carefully read the instruction manual for the battery before use.

Disposal information for countries outside the European Union



This symbol is only valid within the European Union. Follow local regulations when disposing of used batteries. If you are not sure, consult the place of purchase or a bicycle dealer.

Connection and communication with PC

A PC linkage device can be used to connect a PC to the bicycle (system or components), and E-TUBE PROJECT can be used to carry out tasks such as customizing single components or the whole system and updating firmware.

- PC linkage device: SM-PCE1/SM-PCE02
- E-TUBE PROJECT: PC application
- Firmware: software inside each component

Connection and communication with smartphone or tablet

It is possible to customize single components or the system, and update firmware, using E-TUBE PROJECT for smartphones/tablets after connecting the bicycle (system or components) to a smartphone or tablet via Bluetooth® LE.

- E-TUBE PROJECT: app for smartphones/tablets
- Firmware: software inside each component

Cleaning

- The number found on the battery mount key is necessary when purchasing spare keys. Keep it in a safe place. There is a space to enter the key number on the back cover of this user's manual. Enter the key number for safekeeping and later reference.
- Contact the place of purchase for updates of the product software. The most up-to-date information is available on the SHIMANO website. For details, refer to the "Connection and communication with devices." section.
- Do not use thinner or other solvents to clean any of the products. As such substances may damage the surfaces.
- You should periodically wash the chainrings in a neutral detergent. In addition, cleaning the chain with neutral detergent and lubricating it can be an effective way of extending the useful life of the chainrings and the chain.
- Use a damp cloth, with the water well wrung out, when cleaning the battery and plastic cover.
- For any questions regarding handling and maintenance, contact the place of purchase.
- Products are not guaranteed against natural wear and deterioration from normal use and aging.
- For maximum performance we highly recommend SHIMANO lubricants and maintenance products.

Assist

- If the settings are not correct, for instance if the chain tension is too tight, the proper assist force may not be obtained. If this happens, contact the place of purchase.

Label

- Some of the important information contained in this user's manual is also indicated on the battery charger label.

FCC compliance information

This device complies with Part 15 of the FCC Rules.

Operation is subject to the following two conditions:

- (1) This device may not cause harmful interference, and
- (2) This device must accept any interference received, including interference that may cause undesired operation.

NOTICE: This equipment has been tested and found to comply with the limits for a Class B digital device, pursuant to Part 15 of the FCC Rules. These limits are designed to provide reasonable protection against harmful interference in a residential installation. This equipment generates, uses and can radiate radio frequency energy and, if not installed and used in accordance with the instructions, may cause harmful interference to radio communications. However, there is no guarantee that interference will not occur in a particular installation. If this equipment does cause harmful interference to radio or television reception, which can be determined by turning the equipment off and on, the user is encouraged to try to correct the interference by one or more of the following measures:

- Reorient or relocate the receiving antenna.
- Increase the separation between the equipment and receiver.
- Connect the equipment into an outlet on a circuit different from that to which the receiver is connected.
- Consult the dealer or an experienced radio/TV technician for help.

User's Manuals

Instructions on how to use SHIMANO STEPS for drop handlebar bicycles are spread across two documents: your "**SHIMANO STEPS user's manual for your series**" and the "**User's Manual for Drop Handlebar Bicycles**" (this document).

Be sure to read this document along with the user's manual for your series.

User's manuals for each series can be seen at the following website, or accessed from the QR code included in "Important Information on this Product" included with the product:

<http://si.shimano.com>

* "QR code" is a registered trademark of DENSO WAVE INCORPORATED.

■ User's Manual for Drop Handlebar Bicycles (this document)

This describes SHIMANO STEPS configurations for drop handlebar bicycles, how to operate the switches on the dual control lever, and other information.

■ SHIMANO STEPS user's manuals for each series

These describe the following topics not included in the User's Manual for Drop Handlebar Bicycles:

- How to handle the battery
- Assist mode and cycle computer settings
- Troubleshooting

Assist Mode

The assist mode can be selected according to each usage scenario.

[HIGH]/[BOOST]	[NORM] (normal)/[TRAIL]	[ECO]
Sudden ascending slopes	Gentle ascending slopes and level ground	Long distance riding on level ground
When the battery level is low, this reduces assistance and increases the maximum traveling distance.		
[OFF]		
<ul style="list-style-type: none">• When assist is not required• When the battery level is unstable		
[WALK]		
When walking while pushing the E-BIKE		
<ul style="list-style-type: none">• Walk assist mode may not be able to be used in certain regions.		

Quick guide

1. Charge the battery.

It is possible to charge the battery even while it is mounted on the bicycle.

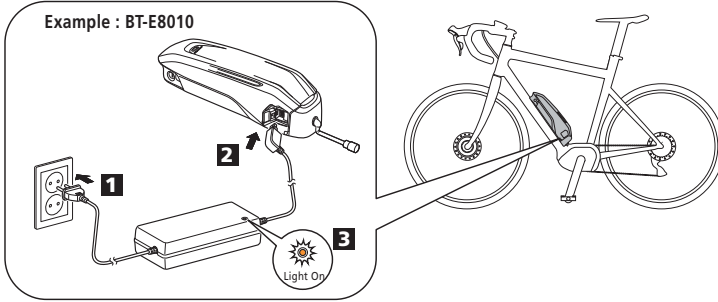

Refer to the user's manual for your series for details.

External type

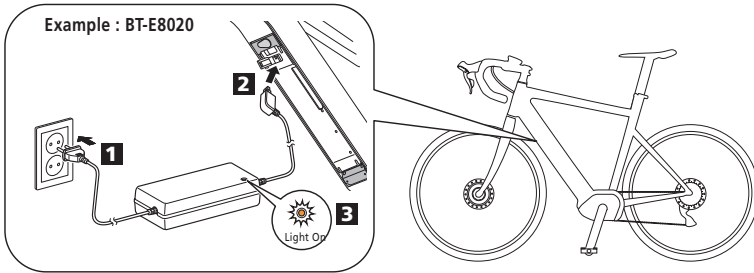

Built-in type



 Lights up	Charging
 Flashing	Charging error

2. Turn on the power.

To turn off the power, repeat this procedure.

External type

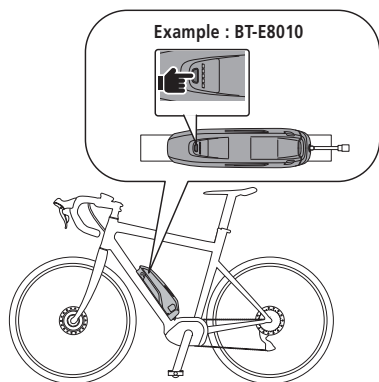

Built-in type

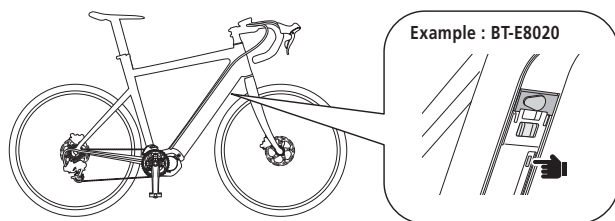

NOTICE

When turning the power ON/OFF, do not place your foot on the pedal.

- 3.** Select your preferred assist mode.
- * When the power is turned on, assist mode is set to [OFF].
 - * The figure shows an example of using the E6100 Series.

Dual control lever (left)

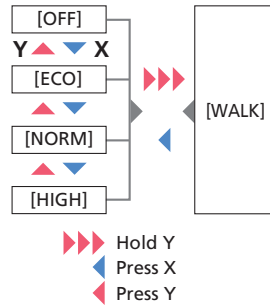
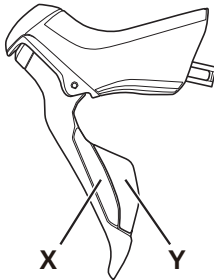

* The Walk assist mode function may not be able to be used in certain regions.

EW-EN100

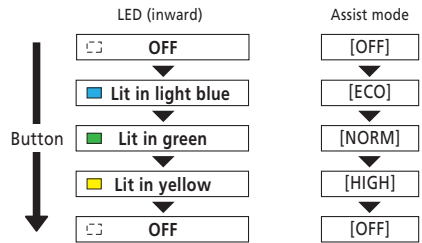
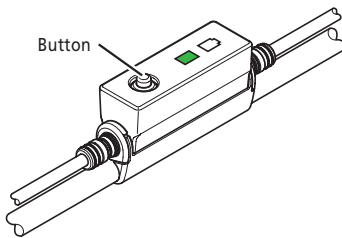

- 4.** Ride the bicycle.
- Assist will start when you start pedaling.



Before riding, please check the brake system of your bicycle and how to operate it beforehand.

- 5.** Turn off the power.

Names of parts

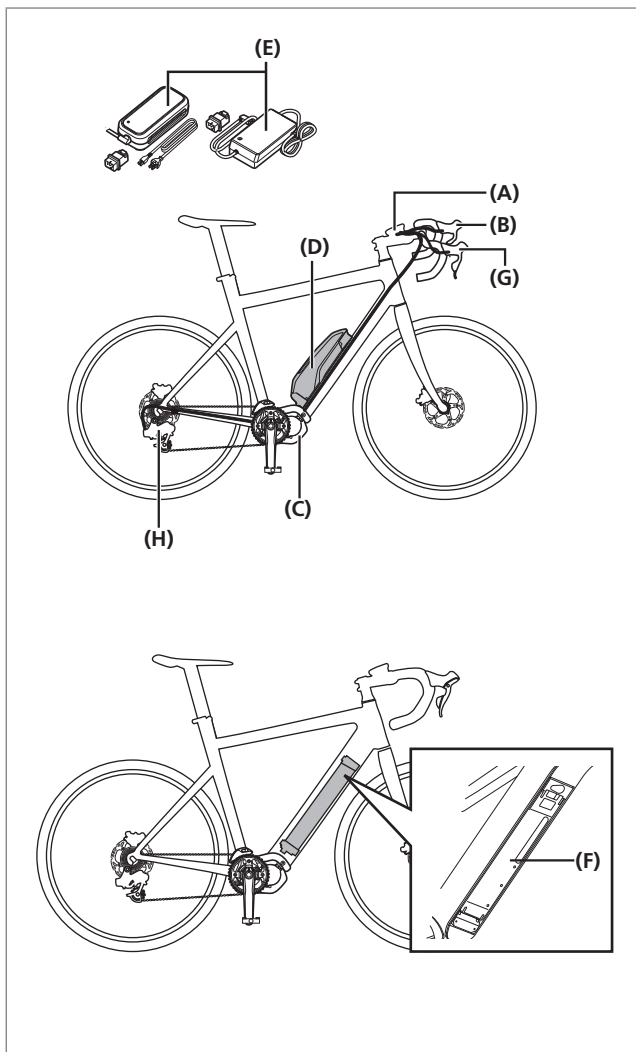

(A) Cycle computer/Junction [A]:
SC-E6100
SC-E7000
EW-EN100

(B) Dual control lever (assist switch):
ST-R8070-L
ST-RX815-L

(C) Drive unit

(D) External type battery/battery mount

(E) Battery charger

(F) Built-in type battery/battery mount

* Refer to the user's manual for your series for information on drive units and batteries.

When using electronic gear shifting

(G) Dual control lever (DI2):
ST-R8070-R
ST-RX815-R

(H) Rear derailleur (DI2):
RD-R8050
RD-RX815
RD-RX817

Operation

Basic operation

This section describes how to use the cycle computer and dual control lever.

- The functions assigned to switches when riding can be changed from those described here. For details, please contact your place of purchase or a local bicycle dealer for assistance.

Cycle computer and dual control lever

SC-E6100

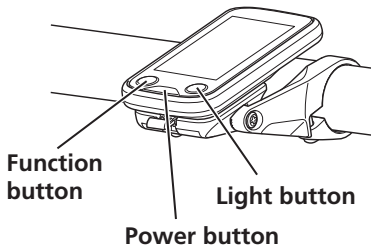

SC-E7000

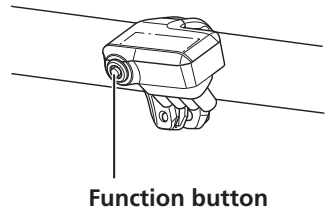

Cycle computer (SC-E6100)

Function button	At riding: change the travel data display on the cycle computer.	Light button	Turn the lights ON/OFF.
	At setting: switch between the screens, confirm settings.	Power button	Turn the power ON/OFF.

Cycle computer (SC-E7000)

Function button	At riding: change the travel data display on the cycle computer. At setting: switch between the screens, confirm settings.
-----------------	---

ST-R8070-L
ST-RX815-L

Remote switch

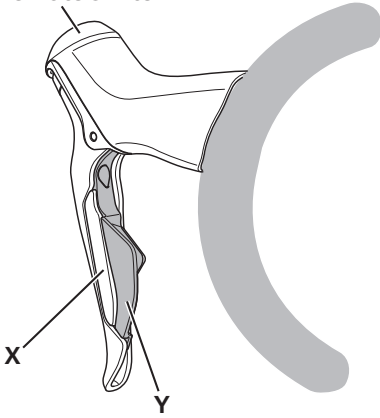

ST-R8070-R
ST-RX815-R

Remote switch

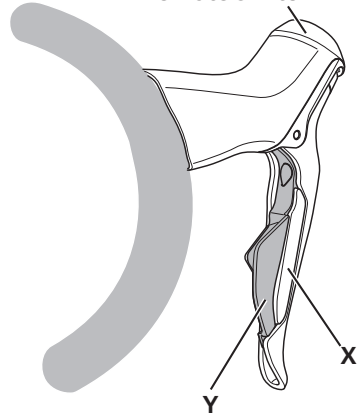

Dual control lever (left) (default: for assistance)		Dual control lever (right) (default: for electronic shifting)	
X	At riding: increase assistance. At setting: move the setting menu cursor, adjust settings, etc.	X	At riding: Shift from a smaller gear to a larger gear.
Y	At riding: decrease assistance. At setting: move the setting menu cursor, adjust settings, etc.	Y	At riding: Shift from a larger gear to a smaller gear.
Remote switch	When riding: Switch traveling data displayed on the cycle computer.		

NOTICE

When the bicycle uses a rear derailleur, be sure to shift gears while pedaling.

Junction [A] (EW-EN100)

EW-EN100 is used instead of cycle computer.

It is attached to the brake outer casing or brake hose and located near the handle bar.

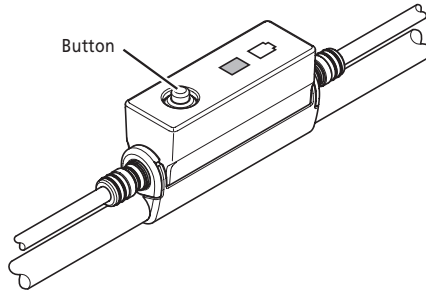

Junction [A]

Junction [A]	
Button	Press: Change assist mode (each time button is pressed). Hold (around two seconds): Light turns ON/OFF. Hold (eight seconds or longer): RD Protection Reset will operate.

- To change to walk assist mode, a switch unit is required.
- The button does not recommend operating this unit while riding the bicycle. Please select your preferred assist mode before riding.
- The RD Protection Reset function can only be used if the rear derailleur is an electronic gear shifting unit.

Refer to the user's manual for your series for information on cycle computer/junction A operations and settings, error messages, and troubleshooting.

SHIMANO

SHIMANO NORTH AMERICA BICYCLE, INC.

One Holland, Irvine, California 92618, U.S.A. Phone: +1-949-951-5003

SHIMANO EUROPE B.V.

High Tech Campus 92, 5656 AG Eindhoven, The Netherlands Phone: +31-402-612222

SHIMANO INC.

3-77 Oimatsu-cho, Sakai-ku, Sakai City, Osaka 590-8577, Japan

Please note: specifications are subject to change for improvement without notice. (English)

© Apr. 2019 by SHIMANO INC. ITP