

SHIMANO

2024 E-BIKE PRODUCT
CATALOGUE

SHIMANO
STEPS

English (GB)



CONTENTS

CONCEPT **04**

DEVELOPMENT PHILOSOPHY

HARDWARE **11**

TECHNOLOGY **17**

SOFTWARE **25**

CONNECTED PARTNERS **30**

SHIMANO SMART CONNECT E-TUBE **32**

PRODUCTS

CHOOSE YOUR RIDING STYLE **34**

PERFORMANCE & SPORTIVE
EP801/EP600/EP800/E7000 **36**

COMFORT & UTILITY E6100/E5000 **60**

E-CARGO EP801/EP600/EP800/E6100 **76**

SYSTEM COMPONENTS **86**

SERVICE PARTS **130**

SERVICE & WARRANTY/FAQ **142**

Carefully Crafted Over A Century, Built On Cycling History

THE ESSENCE OF CYCLING

Our e-bike systems are carefully crafted by drawing from a century of successful technology-driven innovations. Over the past 100 years, we've changed the face of cycling and the cycling industry, starting in 1921 when the 26-year-old Shozaburo Shimano introduced his first product — the freewheel. We've enriched the lives of commuters, leisure cyclists and off-road riders — and enabled pro-riders to compete at the highest levels. Now we've put all of our expertise into one of the most innovative e-bike systems available today. If you truly want to experience the essence of cycling, make the switch to SHIMANO STEPS.





SHIMANO STEPS

INTRODUCTION

Energize Your Lifestyle

NOT ONLY WILL SHIMANO STEPS
TRANSFORM YOUR RIDE BUT IT WILL ALSO
TRANSFORM YOUR LIFE



City Riding And Trekking
E-bike Systems For Day-to-Day Use



Mountain Bike

E-bike Systems For Adventurers

SHIMANO
STEPS

Keeping fit has never been so much fun. Whether you're zipping around the city, coasting through the countryside, traversing tough terrain or scaling mountains – our high-end e-bike systems will be with you every step of the way. They're designed to emulate the riding motion of a regular bike and– thanks to the intuitive pedal-assist – you'll barely notice you're on an e-bike. But you will benefit from the extra support.

Smart, smooth, silent and powerful, Shimano e-bike systems will keep you healthy and agile whatever road you take – and you'll create terrific memories with friends along the way.

We Make E-bike Systems

OUR HIGH-END E-BIKE SYSTEMS CONSIST OF A DRIVE UNIT, BATTERY, DISPLAY, AND ASSIST SWITCH DESIGNED TO WORK SEAMLESSLY WITH A COMPLETE SHIMANO DRIVETRAIN FOR A NATURAL AND ENHANCED RIDING EXPERIENCE.

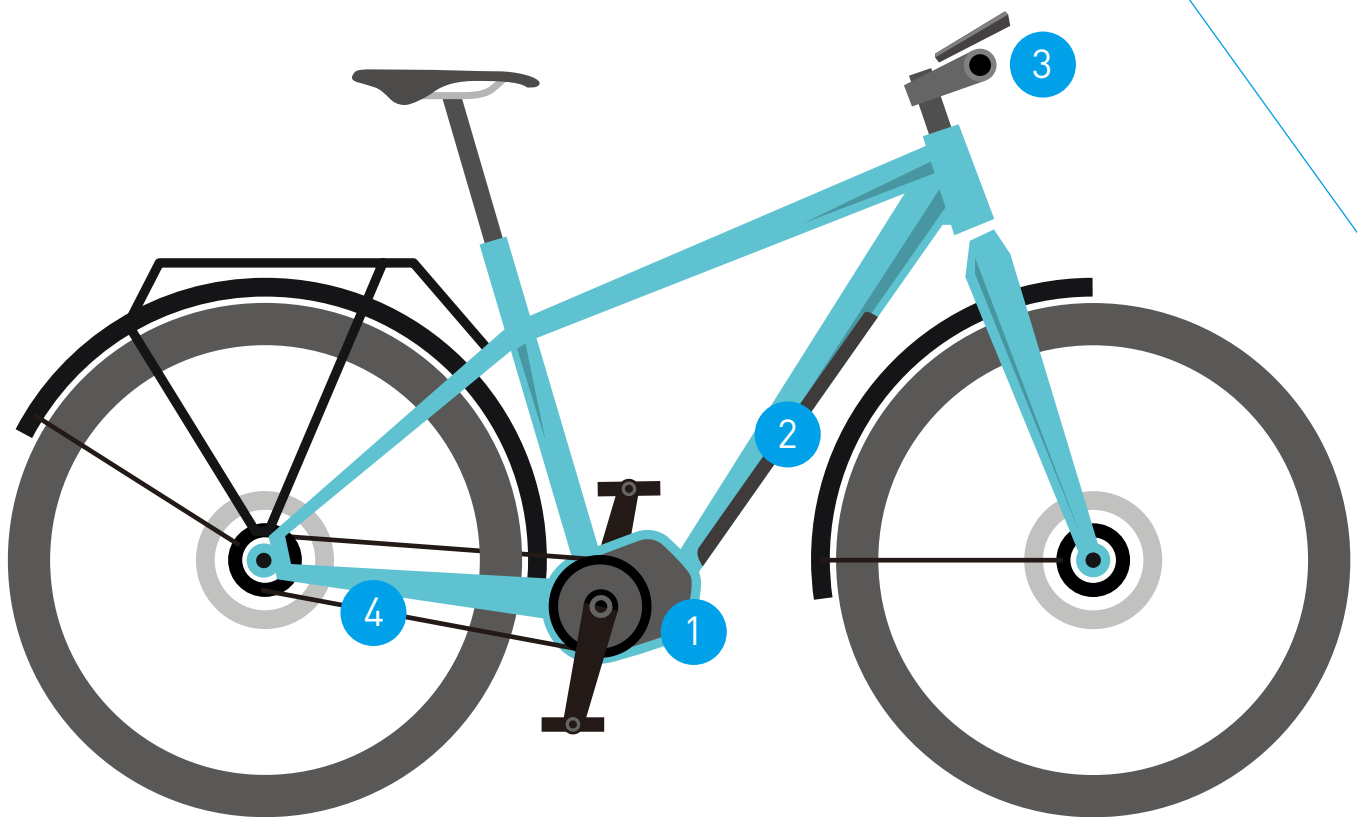



1 — Drive unit

Our powerful and lightweight drive units offer smooth, intelligent pedal-assist to boost your ride up to the legal limit of each region. The mid-motor is mounted at the bike's centre of gravity for neutral handling. While a narrowed pedal-to-frame width ensures a natural riding feel. And it's incredibly durable for all weather conditions.

2 — Battery

Our high-quality Li-ion batteries have a very long life and can handle 500 charge cycles without significant power loss. Plus they have fast charging times — ideal for those who are always on the go. They also give you the freedom to go the distance, knowing you'll get there and back on a single charge.



3 — Cycle computer

Our sleek cycle computers allow you to choose what data you view — and how you view it with multiple display options. Check your speed, distance, gear, trip time, power-assist mode, and more at a glance. Connect wirelessly to your PC, smartphone, or tablet using our Shimano E-TUBE apps to customize your ride to the max. You can even transform your smartphone into a SHIMANO STEPS cycle computer.

4 — Drivetrain

Our fully integrated drivetrain works in perfect harmony with each component — crank, chainring, chain, cassette, rear derailleur or internal geared hub — as they all use Shimano's proven technology. This ensures maximum efficiency and unparalleled performance.

Available On A Wide Variety Of Brands

Shimano e-bike and e-MTB systems come equipped on a wide variety of bike brands. Browse your favorite at lifestylebike.shimano.com

Development Philosophy

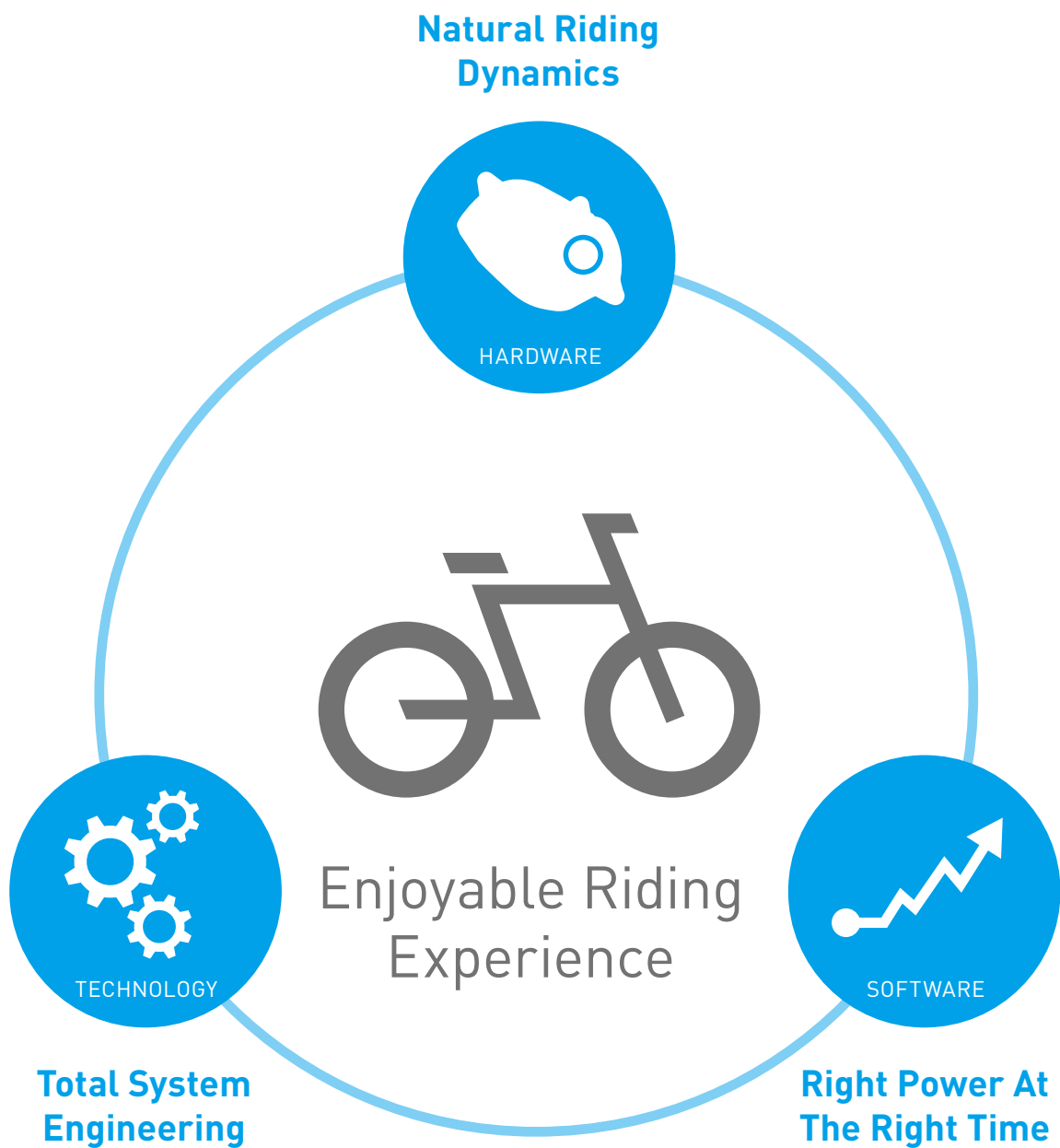

A BIKE ENGINEERED PEDALING INTERFACE FOR MORE NATURAL BIKE CONTROL

Lightweight

As with any Shimano design, we continue to find ways to reduce component weight to improve handling and bike control.

When it comes to optimal performance off-road, you want a light, agile and nimble ride. At 2.6 kg, the EP8 DU weighs 300 grams less than predecessor drive units. It is truly one of the lightest drive units available and delivers best-in-class power for its weight.



EP801

Compact & Powerful

Don't let size or looks deceive you. This sleek, slender and slim drive unit packs a robust 85 N·m of power to get you to the top of your next epic descent.

A more compact, integrated drive unit also allows for increased ground clearance for when the trail turns technical.



Left Side View

Rear View

EP8 vs. DU-E8000

Quieter

Despite its increased power, the EP8 drive unit operates almost silently so you can fully enjoy the natural sounds of the trails without distraction.

Our EP800 Drive Unit is 2dB quieter than our E8000 DU (achieving the same volume output as E7000) while outputting higher max levels of assist.

Handle The Heat

Thanks to the combination of materials with robust heat dissipation, a larger moulded-in surface area, and a completely redesigned motor housing, EP801 can handle rising temperatures on climbs, meaning you get the maximum torque for an extended period of time.

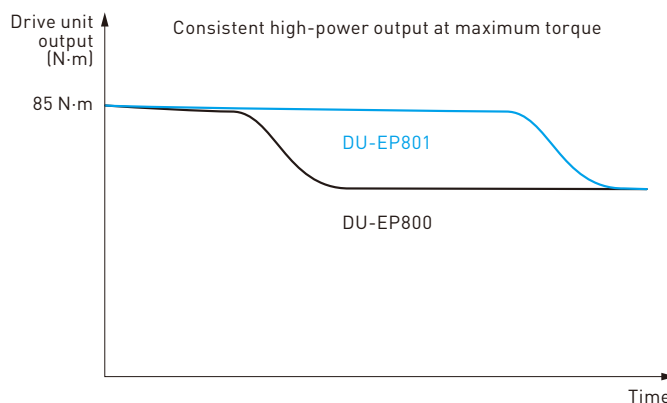

Smoother Pedaling

We believe all riders should feel in complete control in the saddle. This belief, combined with our rider first design approach, means we have raised the benchmark yet again to reduce drag by a further 36%.

An improved clutch mechanism results in a more responsive ride, allowing for a smoother cut-off when pedaling above the legal speed limit in each region.

EP8 delivers smooth pedaling and no surprises.

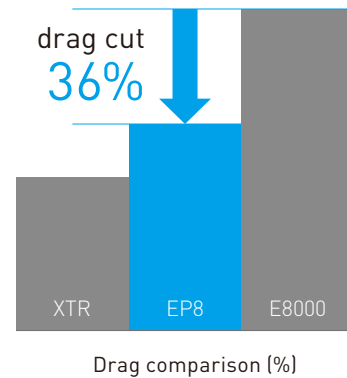

Zero Offset And Narrower Q-Factor

Our e-bike systems have zero offset and the same Q-factor as conventional bikes. This enables a more direct linear delivery of rider power from their hips, down through their legs, and transferred to the pedals.

When you exceed the motor-assist limit of 25 km/h, you'll appreciate this natural feel as you get the most out of each pedal stroke.

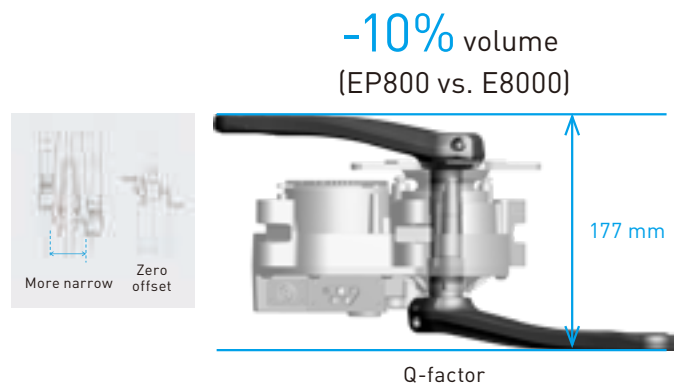

Short Chain Stay

The drive unit has been designed so that frames can have the same chain stay length as conventional bikes.

The short chain stay specification allows frame makers to design power-assisted bikes that provide the same maneuverable handling and authentic feel of conventional bikes.

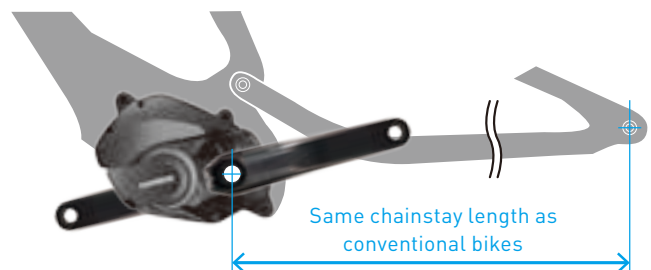

SHIMANO BATTERY SOLUTIONS

Shimano batteries and chargers are IPX5 water-resistant so you don't have to lug your batteries inside to recharge. Being able to quickly charge your bike outside is a quality of life improvement that is a huge benefit for riders who want a fast boost of range while stopping for a meal or meeting friends.

Shimano battery systems deliver long-life operation and can be stored safely at a wide range of temperatures for year-round enjoyment under any conditions.

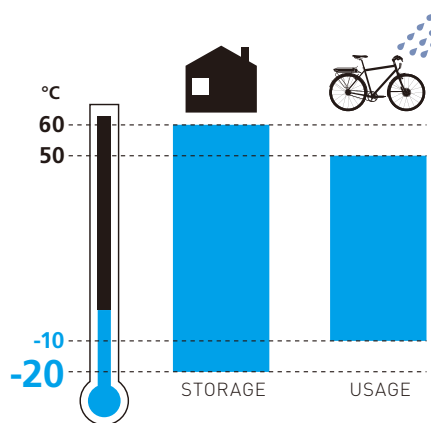
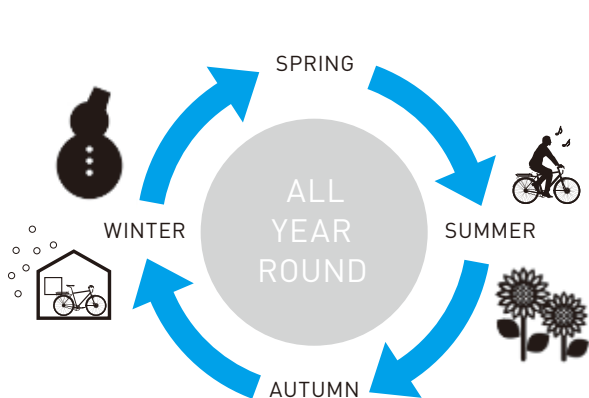

Anti-aging battery

The durable battery retains a greater charge for a longer time

SHIMANO STEPS utilises a long-life battery to maintain sufficient output, even after 1,000 charges.

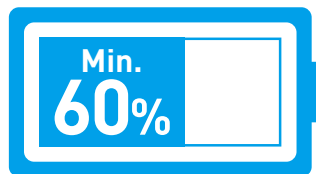

After 1,000 charges:
Holds at least 60%
of initial capacity

High Level Water-Resistant Performance And Quick Charging (EC-E8004)

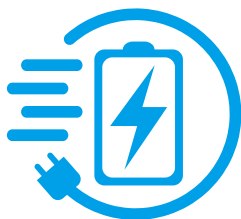

	 80% charged	100% charged
418Wh	2h	3h
504Wh	2.5h	4h
630Wh	3.2h	4.8h

Note: When charged with EC-E8004

RIDING DISTANCE

Shimano original assist algorithms are developed and improved based on rider experiences and desires. SHIMANO STEPS relies on the combination of its sensors, drive unit tuning and efficient pedaling mechanics to deliver a riding experience that is both highly sophisticated and intuitive at the same time.

Real-time riding data from the torque, cadence, and speed sensors are analyzed to detect the optimal assist for every moment. Automatically-applied assist output characteristics (Powerful and Natural) make the most of every pedal stroke and battery charge. The optimal amount of support provided at the right time also reduces harsh and unnatural surges of power, keeps pedaling smooth, and supports a more natural cycling experience in any environment.

Singletrack Course* Performance

EP800 is 20% more powerful than E8000 while providing the same great riding range on a single track test course* packed with steep climbs.

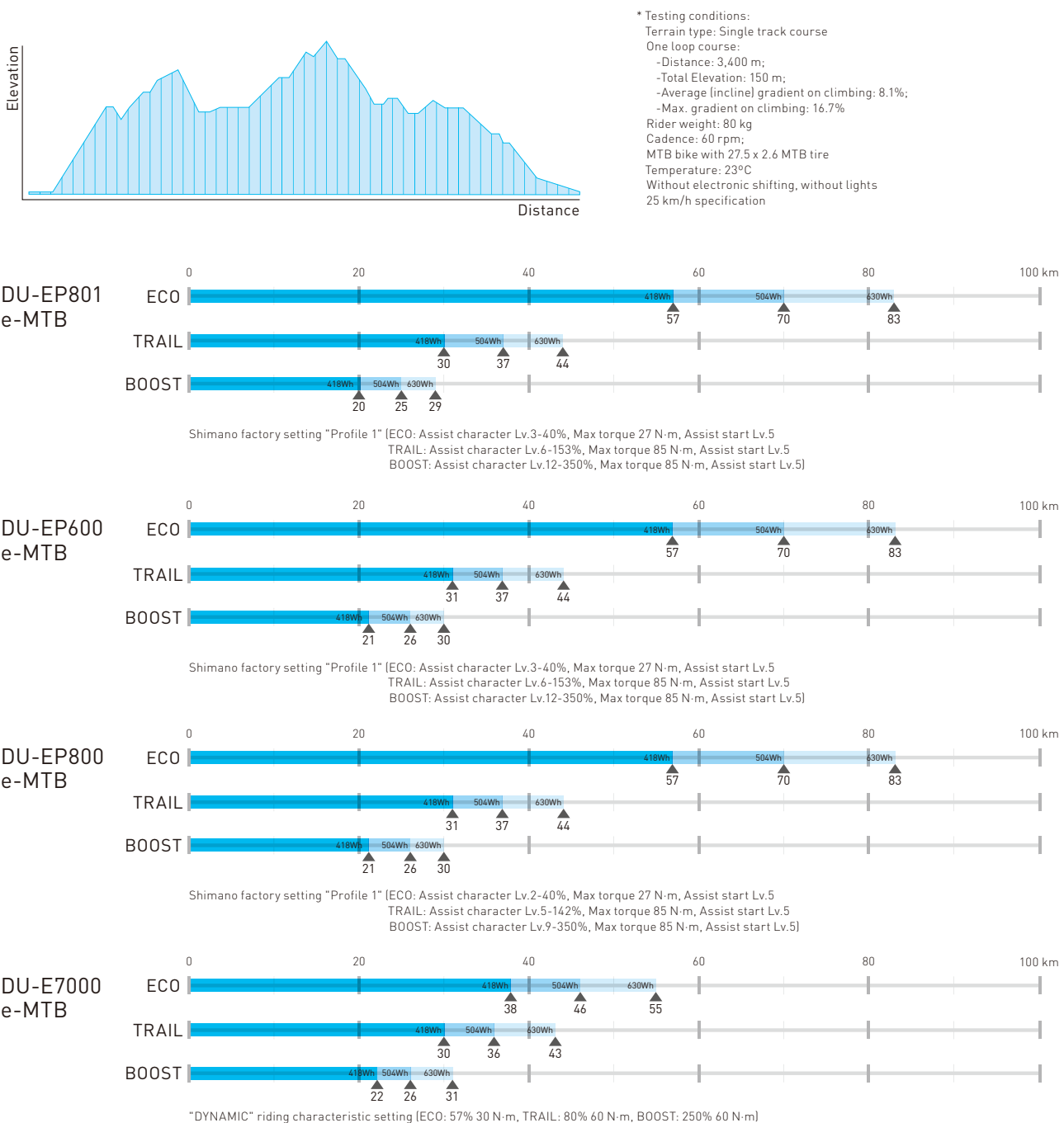

Note: These figures represent expected range for new rechargeable batteries and may vary over time or if used outside of these specific testing conditions.

Flat Paved Road Course* Condition

Shimano tested battery ranges for each drive unit and mode

The range figures below show tested battery ranges* for different battery sizes on mostly flat commuting or touring rides in cities and suburbs. Actual range can be reduced by non-optimal conditions. e.g. long and or frequent elevation gain, below freezing temps, etc.

FLAT CRUISING



* Testing conditions:
Flat paved road, cadence: 60 rpm, rider weight: 80 kg, speed: 23 km/h; outside temperature: 23°C, Trekking bike with 700 x 38C tire, without electronic shifting, without lights.

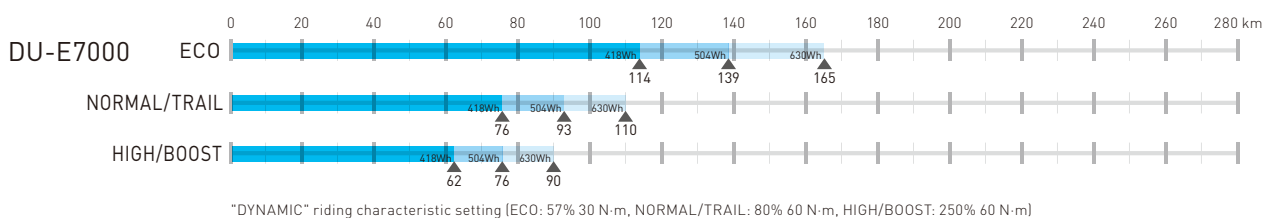
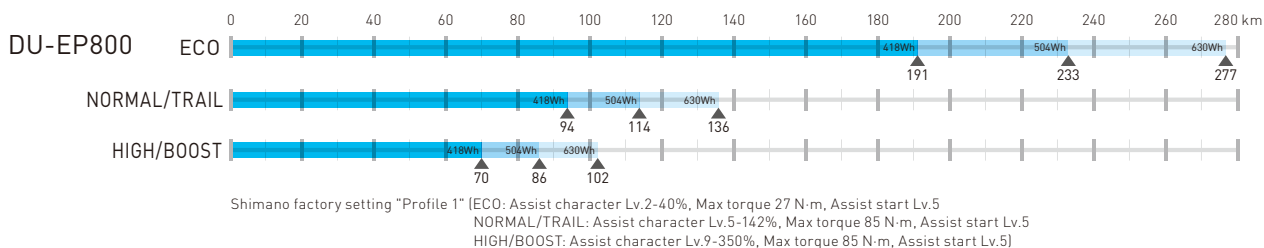
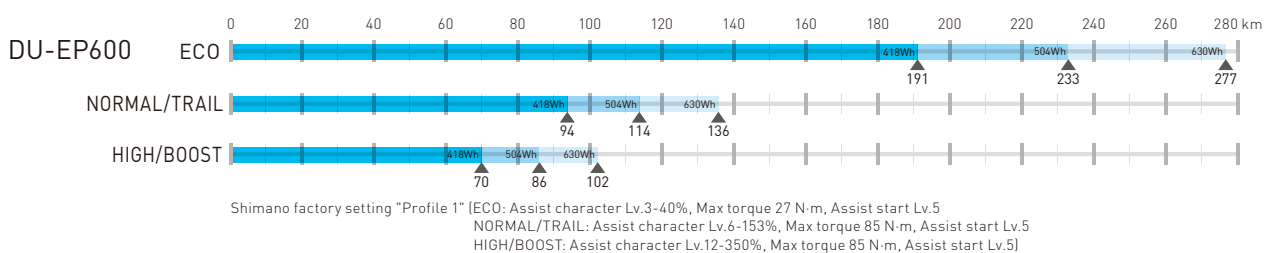
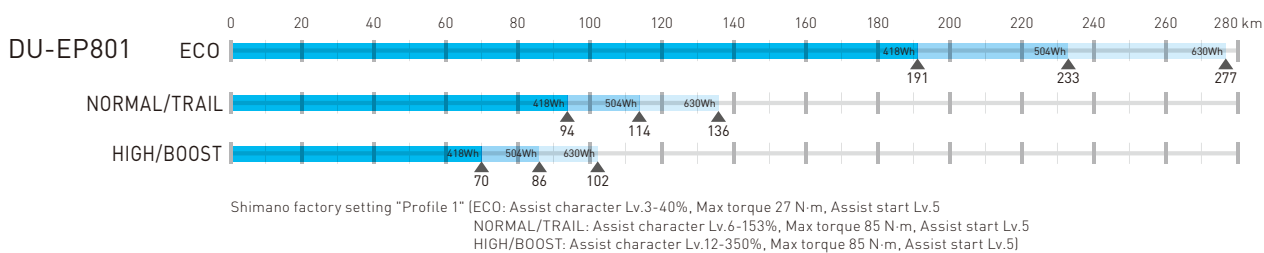

Note: These figures represent expected range for new rechargeable batteries and may vary over time or if used outside of these specific testing conditions.

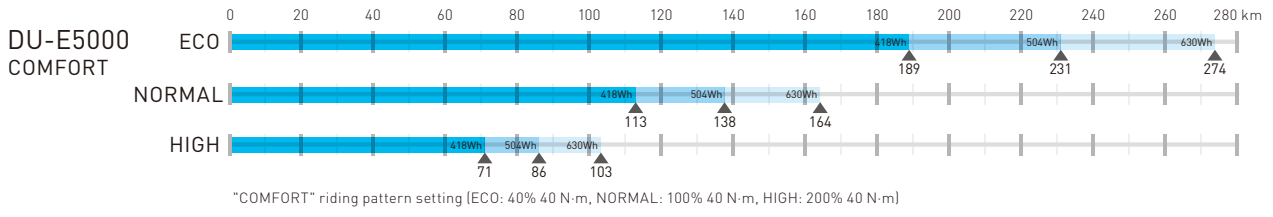
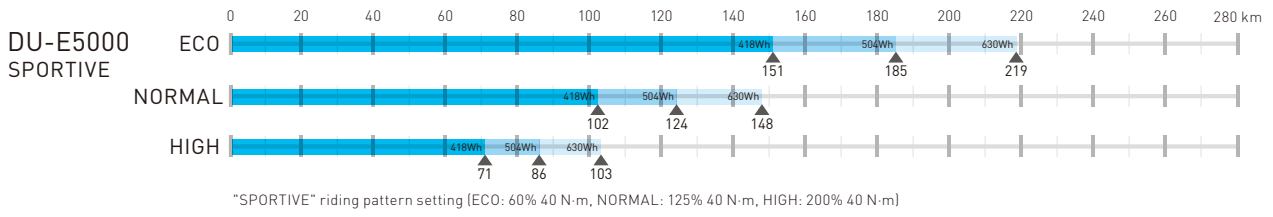
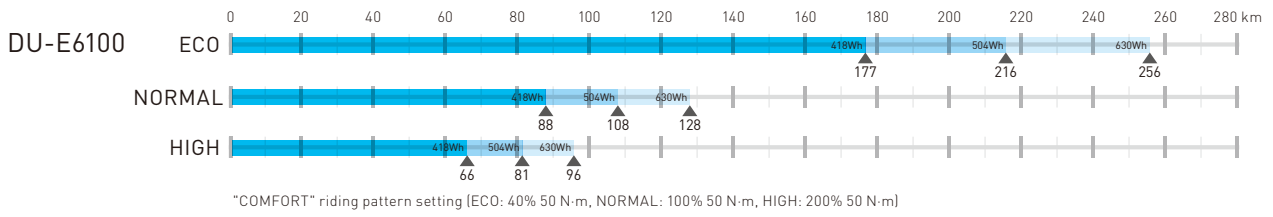

Note: These figures represent expected range for new rechargeable batteries and may vary over time or if used outside of these specific testing conditions.

SHIFTING TECHNOLOGY



LINKGLIDE delivers seamless shifting and pedaling performance that's made to last. LINKGLIDE will support stress-free riding and ownership experiences for evolving bike types and riding styles for years to come. It is an exceptionally durable drivetrain built to stand up to persistent daily wear and provide enduring shifting and pedaling performance for multi-purpose bikes and high-torque e-bikes.

The robustly engineered cassette design shifts up and down gears seamlessly while significantly reducing drivetrain wear. LINKGLIDE is the ultimate utility drivetrain that delivers long-lasting performance.

3X Durable

Drivetrain durability is essential for high torque e-bikes and daily riders who might ride in the same gear for months or years at a time. LINKGLIDE provides smooth and decisive shifting that lasts longer than ever before.

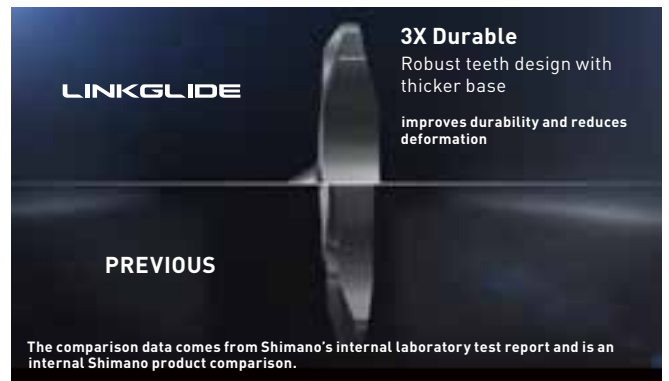

Increased longevity/less skipping

LINKGLIDE's re-designed cassette teeth have a substantially thicker base and a unique chamfer that drastically improves wear resistance in high torque applications. This increase in cassette durability prolongs smooth driving performance and lengthens the amount of time before chain skips caused by wear start to happen.

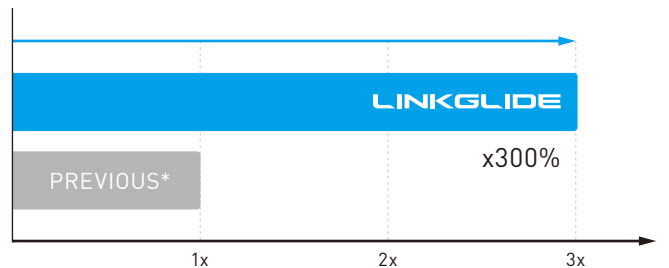

Test condition: keep chain rotating under muddy conditions on drivetrain without shifting. The average data of 11T, 13T, 15T.
*PREVIOUS = HG (HYPERGLIDE)

Robust teeth design

A major advantage of the LINKGLIDE platform is that the robust teeth shape provides excellent durability and improved wear resistance. This is very important because riders who often buy bikes at this level, choose bikes with gearing but may forget to shift or maintain their bikes as often as they should.



1,200 shifts = Loss of performance

5,000 shifts = Shift smoothness retained

*PREVIOUS = HG (HYPERGLIDE)

3X Smoother

LINKGLIDE consistently delivers smoother, more even pedaling while shifting that you can barely feel at your feet.



Smoother pedaling from start to finish

Crank idling angle during up/outward shifts (lower = smoother)

LINKGLIDE delivers up to three times smoother performance by improving the chain's flow between cogs. This smoother handoff reduces the stress of shifting shock for more seamless and enjoyable riding.

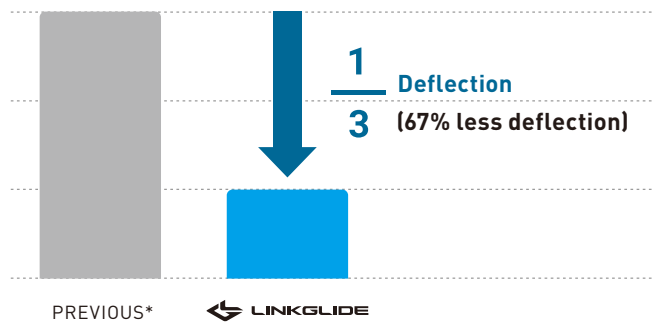

Test condition: repeated inward and outward shifting.
 The average data of 11T, 13T, 15T
 *PREVIOUS = HG (HYPERGLIDE)

LINKGLIDE's optimized shifting gate design that creates a smoother handoff between cogs to avoid the jumps that can impact shifting and pedaling smoothness. This design improvement is especially pronounced on outward shifts where pedaling shock is more noticeable due to the larger forces involved.



AVAILABLE SERIES



U8000/U6000/U4000 Series



M8100 Series



M5100 Series



<https://bike.shimano.com/en-EU/technologies/component/details/linkglide.html>

Fusion Of Drivetrain x Power Assist x Intelligence

DRIVETRAIN x POWER ASSIST x INTELLIGENCE into a More Complete Bike
Only Shimano can deliver a fully integrated ecosystem



AUTO SHIFT

WITH MANUAL OVERRIDE

SHIMANO develops every part of our revolutionary AUTO SHIFT system in-house, allowing us to create targeted value for various riding styles. AUTO SHIFT for e-city and e-trekking enhances cruising enjoyment with a consistent pace and intensity decided by the rider. AUTO SHIFT for e-MTB is designed to help trail riders keep their flow while making their way up, down, and around the mountain.

Our new automatic shifting system combines automatic convenience with manual control. SHIMANO AUTO SHIFT is designed to keep you in the right gear for each moment, while also allowing you to make manual shifts any time you want to override the shifting algorithm.

MAKE COMFORT A CONSTANT

AUTO SHIFT for e-city and e-trekking delivers comfortable pedaling throughout your ride and eliminates gear shifting stress. Thought-free shifting helps you ride with a smooth and steady pace when riding uphill, into headwinds, or when you're feeling worn out.

AUTO SHIFT also supports controlled and efficient pedaling after long descents down hills or bridges.

AUTO SHIFT makes e-city and e-trekking easier than ever by automatically shifting you into a lighter gear while coasting or coming to a stop.

So when it's time to go, you always start smoothly under control.



HOW DOES IT WORK?

AUTO SHIFT is an automatic shifting technology that monitors your pedaling dynamics to keep you in the right gear and focused on what matters in every moment. Multiple system sensors continually measure your cadence, torque, and speed to automatically move you into the optimal gear without requiring you to shift manually. As your speed and cadence slow and torque increases, the

system selects an easier gear. When you start pedaling and speed up, the system shifts to a higher gear for you, so you can always be in the right gear at the right time. Focus on what matters with AUTO SHIFT.

FUNCTION COMPATIBILITY

AUTO SHIFT while pedaling is compatible with e-bikes equipped with Di2 shifting and an 11-speed or 10-speed LINKGLIDE drivetrain.

AUTO SHIFT while coasting is compatible with e-bikes equipped with Di2 shifting and a 12-speed HYPERGLIDE+, or

a 10-speed/11-speed LINKGLIDE drivetrain. Please visit si.shimano.com for more detailed compatibility information.



FREE SHIFT

FREE SHIFT for e-MTB helps you emerge from every descent and corner with the more controlled flow by eliminating the need to pedal while shifting.

KEEP YOUR FLOW WITH PEDAL-FREE SHIFTING

FREE SHIFT for e-MTB reimagines mountain biking control by helping riders stay focused on the trail and their body positioning while cornering and descending.



FOCUSED CORNERING

Being able to shift to the right gear without pedaling will change how you think about cornering. FREE SHIFT helps you focus on planning your line and maintaining a stable body position for greater control and acceleration after corners.

FOCUSED DESCENTS

FREE SHIFT for e-MTB helps you keep a stable body position by allowing you to change gears mid-descent without pedaling. Riders with FREE SHIFT can emerge from descents prepared for trail changes and avoid spin-outs or being overgeared.

HOW DOES IT WORK?

FREE SHIFT is available on compatible e-bikes with Di2 shifting. While coasting, the drive unit uses just enough power to rotate the chainring and cassette to smoothly

complete shifts and does not affect the acceleration of the e-bike.

FUNCTION COMPATIBILITY

AUTOMATIC FREE SHIFT while coasting requires a compatible Di2-equipped bike with a 12-speed HYPERGLIDE+ or 10-speed/11-speed LINKGLIDE drivetrain.

Please visit si.shimano.com for more detailed compatibility information.



E-bike Di2 Internal Geared Hub Automatic Shifting (INTER-8/INTER-5E)

INTER 5 BIKE DESIGN

EP8/EP6/E6100 and E5000 series drive units in combination with a Di2-compatible 8/5 speed internal geared hub offer full automatic shifting. The SHIMANO STEPS system automatically selects and shifts into the optimum gear based on the number of crank rotations and speed.

When riders manually shift in auto mode, the SHIMANO STEPS system uses a learning function to recognize the manual shift and automatically fine-tunes future automatic shift timing to the rider's liking. This offers a stress-free ride, eliminating the need for the rider to worry about whether they're in the right gear or have to change gears after an abrupt stop.

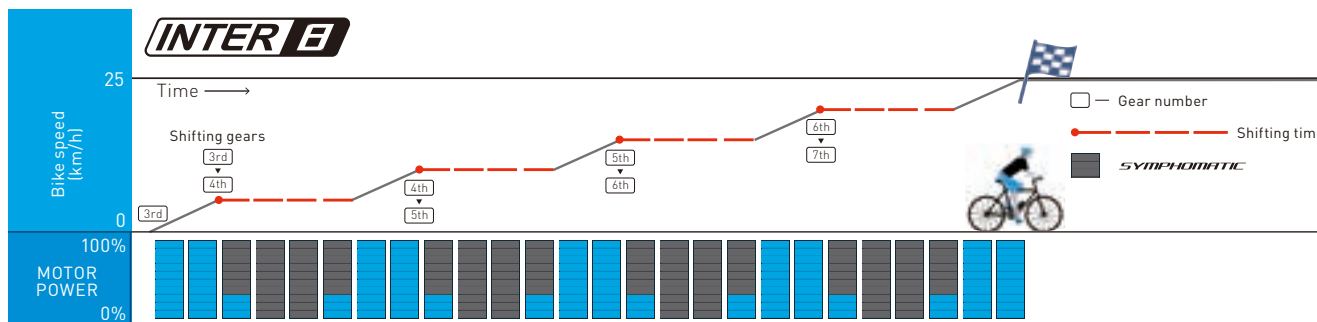
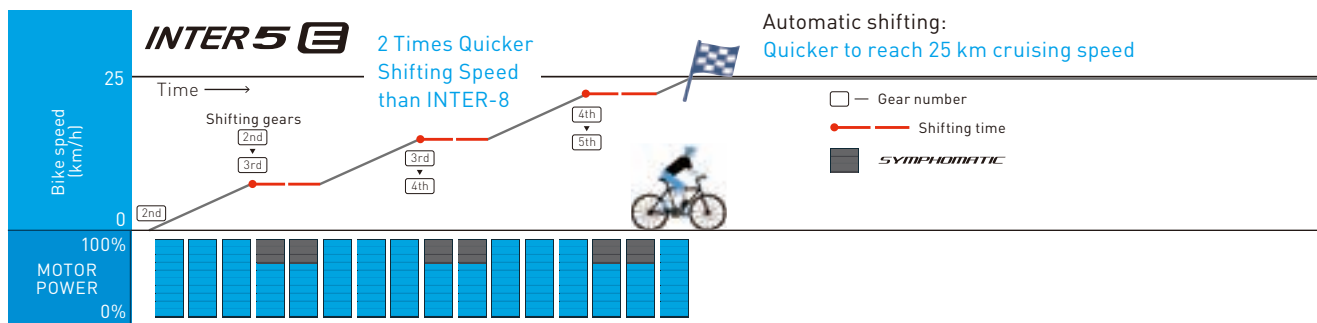

Comparison of gear steps

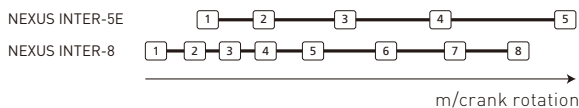

The NEXUS INTER-5E shifts faster under higher load compared to other internal gear hubs because it doesn't need to decrease assist power to 0%. Wide gear steps between the 3rd and 5th gear ensure you reach 25 km/h twice as fast as the NEXUS INTER-8 and with fewer shifting actions.

SYMPHOMATIC

SHIMANO STEPS computer-assisted shifting system provides more responsive and stable shifting performance. This innovative system monitors rider's motion and determines the optimal timing to momentarily decrease power to the pedal assist motor. The temporary reduction of chain tension allows smooth and unimpeded gear movement.

Intelligent Walk Assist*

When walking the bike up a mountain trail, intelligent walk assist automatically adjusts drive unit output torque to keep the bike speed at 4 km/h no matter which gear ratio is used.

Starting with EP800, mechanical walk assist has been improved to the same level as Di2 Intelligent walk assist to make off-the-bike handling even easier for more riders.

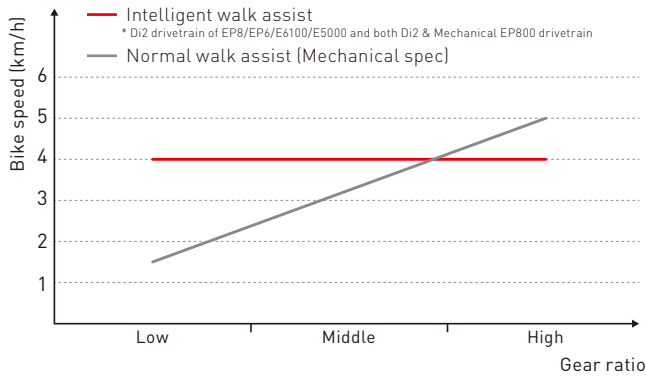

	Intelligent walk assist	
	Di2 drivetrain	Mechanical drivetrain
EP801/EP600/EP800	✓	✓
E8000/E7000/E6100/E6110/E5000	✓	—

[How to operate]

- 1. Stop and switch to walk assist mode**
Hold down Button-Y until walk assist icon is displayed.
- 2. How to start walk assist mode**
Hold down the Button-Y continuously while pushing the bike.
- 3. Exit walk assist mode**
Press Button-X.

* The walk assist mode function may not be able to be used in certain regions. (Singapore, Brazil)

Start Mode

The drive unit automatically switches to a lower gear to provide the rider with an easier restart when stopping for traffic lights, crowds, or other situations. This makes it easy to start off again without wobbling forward while struggling to pedal, in case you forget to shift down when coming to a stop.

This unique Shimano Di2 technology is especially useful in urban areas, which require frequent stopping and starting. Use a cycling computer or E-TUBE PROJECT to set the rider's desired gear when starting off.

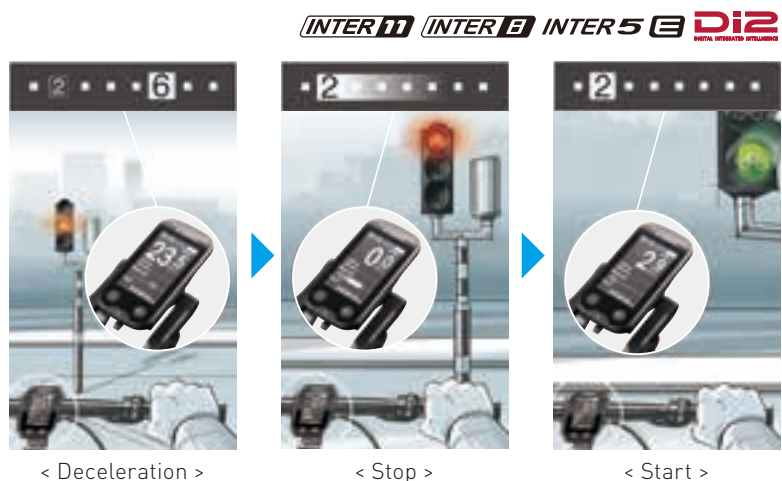

ANTI-LOCK BRAKING SYSTEM

ABS SHIMANO + blubrake

* Please note that our ABS products are currently only available in the following countries: Belgium, Denmark, Estonia, Finland, France, Iceland, Italy, Latvia, Lithuania, Luxembourg, Malta, The Netherlands, Norway, Poland, Spain, Sweden

MAKING CYCLING SAFER

The bicycle continues to be a favored mobility device because of its ease of use, low environmental impact, and adaptability. SHIMANO Anti-lock Braking System by Blubrake enhances e-bike safety to help riders stay safer and reduce common causes of e-bike accidents.

Stay in control

SHIMANO ABS by Blubrake helps lower the risk of uncontrollable skids caused by the front brakes biting too hard and locking up the front wheel.

Stay grounded

Our ABS also helps lower the risk of the rear wheel lifting and launching the rider over the handlebars when the front brakes are applied too forcefully.

Stay in control with SHIMANO ABS by Blubrake

Our ABS helps riders retain bike stability and stop safely on wet/dry pavement and rough surfaces* by keeping both wheels on the road and rolling. A speed sensor on the front wheel monitors wheel rotation and activates ABS if the wheel slows beyond what is expected for the bike's speed. When ABS is activated, the system applies modulated braking force on the front wheel to reduce the chances of the front wheel locking up and/or the rear wheel lifting.

*This ABS is not intended for steep downhill or aggressive mountain riding.



Cycling in the city

Fully enjoy e-bike commutes and leisure rides with the ability to safely react to pedestrians or vehicles with smooth and controlled deceleration, even on wet or snowy roads.



Off-road control

The ABS's braking algorithms are tuned to provide greater grip and traction for e-biking on mildly rough terrain.



Confidently carry cargo

E-Cargo bikes have powerful brakes designed for stopping with heavy loads. Our ABS lowers the risk of front-wheel lockup when traveling light so you can stay in control no matter how much you're hauling.

OUR ABS CAN HELP HEIGHTEN THE SAFETY OF ALMOST ANY E-BIKE.

- The compact control unit combines electronic and mechanical parts and can be neatly integrated inside a bike frame.
- The external version (BS-AS300-0) can be added to existing frames with a bottle cage mount without any special modifications and is compatible with a wide range of frames and forks.
- It is compatible with a wide range of SHIMANO brakes and e-bike styles.
- It can be installed on bikes with wheel sizes ranging from 16 to 29 inches.



1 ABS MAIN UNIT

The sleek tube-shaped ABS main unit tucks easily into compatible frames to provide more control in more conditions.



2 ABS SPEED SENSOR KIT [CENTER LOCK]

The SHIMANO CENTER LOCK disc brake rotor front wheel speed sensor accurately and continuously measures wheel speed.



3 CYCLE COMPUTER

SC-EN600
SHIMANO STEPS Cycle Computer



SC-EN610
SHIMANO STEPS Cycle Computer

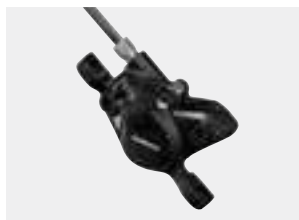

4 BRAKE

BR-MT200
SHIMANO Hydraulic Disc Brake 2-Piston MTB Caliper



BR-MT420
SHIMANO Hydraulic Disc Brake 4-Piston Caliper

SERVICE

The ABS unit, brake kit, and drive unit are all manufactured and provided by SHIMANO, so if you ever have an issue, you can count on our reliable support to get you moving again.

COMFORTABLE IN ANY SITUATION

There are no shortcuts when creating a truly enjoyable e-bike riding experience. Just like all our groupsets, SHIMANO STEPS works in perfect harmony with our bike components. It is only when every part of the system is engineered and balanced together, that it becomes possible to provide the level of comfort, control and response that delights riders. Greater system efficiency means more riding range on fewer charges, and longer overall battery life.

With every stroke of the pedal, you can practically feel the years of hard work that went into creating more synergy between rider, pedaling and assist.

Enjoy longer and more enjoyable rides whether you take the scenic way home, venture farther, or tackle tougher mountain trails.



THE RIGHT POWER AT THE RIGHT TIME

Shimano Re-Booted TRAIL Mode For E-MTB

Shimano TRAIL mode sets its assist output characteristics to focus on bike control in the fast-changing conditions of MTB. TRAIL mode delivers optimal assist power when riders need the best performance, so you receive the right power at the right time, safe in the knowledge you'll always have maximum traction and control. Whether tackling loose sand or steep mountain ranges, the drive unit rapidly and seamlessly self-adjusts so you can concentrate fully on the trail ahead.

Why is Shimano TRAIL mode suitable for such a wide range of riding conditions?

It provides linear response output assist without sudden changes or idle spinning of output torque by maintaining a consistent output ratio. TRAIL mode optimizes rider control, lowers energy consumption at low input torque, and provides additional support to power up the trail when the rider pushes harder.

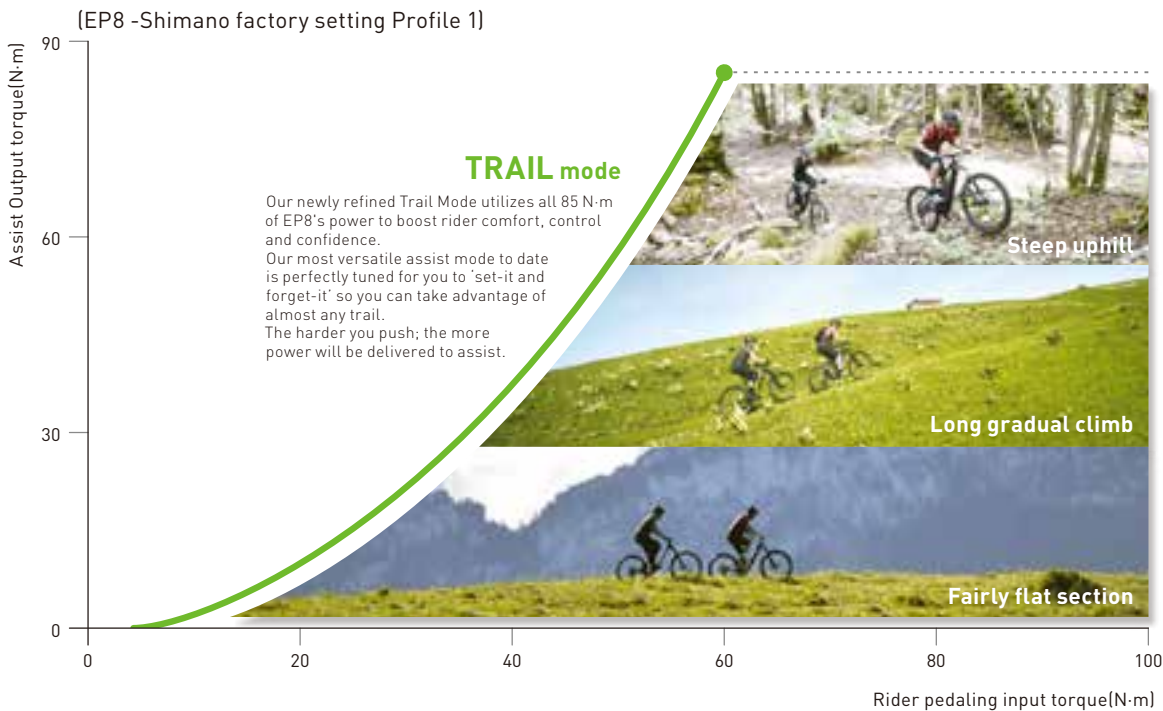

EP8 refined "TRAIL" mode feature compared with E8000

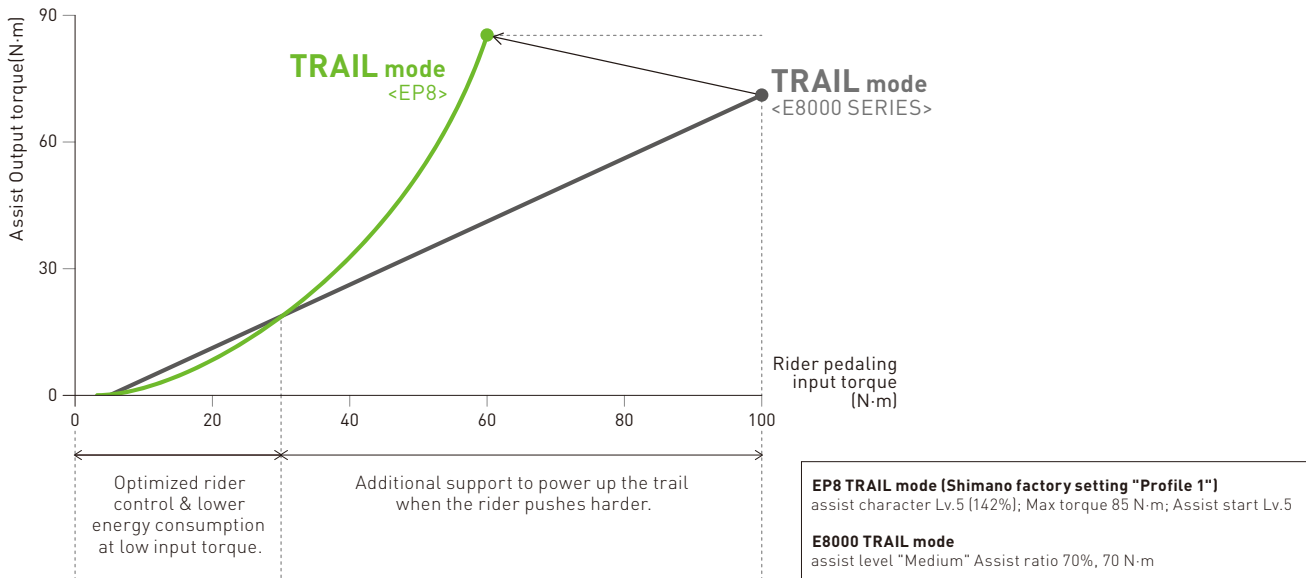

Dedicated E-Cargo Firmware

E-Cargo dedicated firmware provides quick power delivery from 0 km/h. It helps smoother acceleration for heavy cargo bikes to reach stable cruising speed faster.

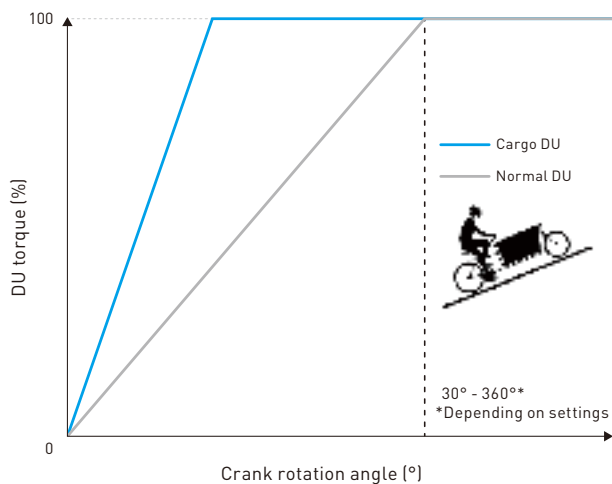

Swap Between Customizable Rider Profiles On The Fly

To get you out there riding, we've pre-loaded two profiles with three adjustable modes* that are accessible via your display and can be set to match the rider's needs. For example, Profile 1 can be set for more typical commuting and light trails, while Profile 2 can be maxed out for the most intense or demanding routes. This will have you covered for a variety of terrain, from challenging singletrack and flowing fire roads to technical rocky sections.

* Need to connect to E-TUBE PROJECT application to adjust each mode in advance.

Save your preferences as two different profiles and switch between them easily via your display when swapping the commute for weekend trails.

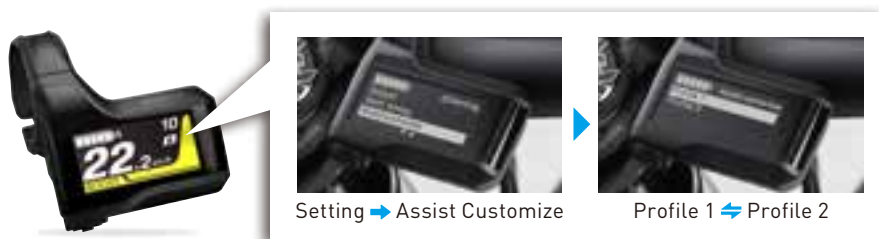

E-TUBE PROJECT

The E-TUBE PROJECT Cyclist App allows you to wirelessly adjust system settings to your individual needs and easily update your firmware. Future versions will add new ways for riders to focus, explore, and take control of their e-bike experience.

1 Power adjustment/customization to fit your unique riding style

You can customize assist profiles (1 or 2) in our E-TUBE PROJECT Cyclist App

* BASIC MODE and FINE-TUNE MODE settings for each Profile may vary depending on the factory setting chosen by each bike brand.



Profile 1

Riders have the option to set BASIC MODE to Profile 1* for general

BASIC MODE — Classic assist support with 3 patterns

Ride at ease with BASIC MODE and its three customizable assist patterns (ECO, TRAIL, and BOOST or ECO, NORMAL, and HIGH) for smooth support in most conditions.



Profile 2

Everyday riding and FINE TUNE MODE to Profile 2* for more specialized assist

FINE TUNE MODE — Targeted assist with up to 15 patterns

Take more precise control with up to fifteen assist patterns in FINE TUNE MODE. This allows riders to adjust assist patterns to match pace with group riders at a comfortable cadence, and better match specific routes or trails.

Each MODE allows riders to adjust 3 parameters:

Select up to 15 customizable assist patterns

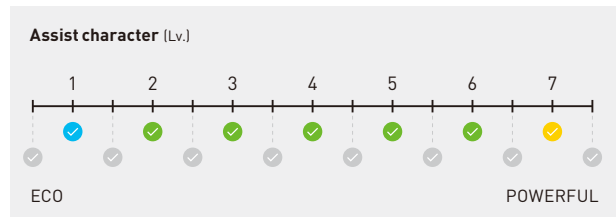

For FINE TUNE MODE, and 3 customizable assist patterns for BASIC MODE.

Max torque

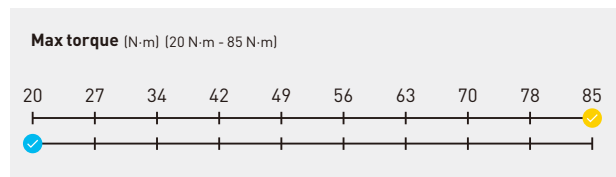

Freely adjust the lowest and highest assist patterns' maximum torque.

Assist start

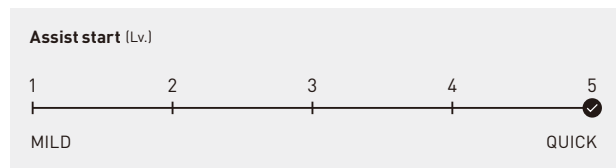

Adjust how quickly assist starts with multiple levels to choose from.

- These three images show the adjustment parameters of FINE TUNE MODE. BASIC MODE also allows you to adjust the assist character, max torque, and assist start using a different interface.
- The adjustable range of the above three parameters may vary depending on the factory settings chosen by each bike brand.

2 AUTO/FREE SHIFT CUSTOMIZATION

Our E-TUBE PROJECT Cyclist App also allows you to customize the shift settings of the new AUTO SHIFT and FREE SHIFT features, creating an e-bike riding experience that is truly yours.

ADJUST RIDING SCENE



PAVEMENT : AUTO SHIFT is tuned for urban traffic

MTB : AUTO SHIFT responds more rapidly to changes in the trail and is good for active ride

* Available with RD-M8150-12/11.

ADJUST SHIFTING TIMING



S L O W E R : Slide left for a slower cadence

F A S T E R : Slide right for a faster cadence

ADVANCED SETTING MENU: Climbing response

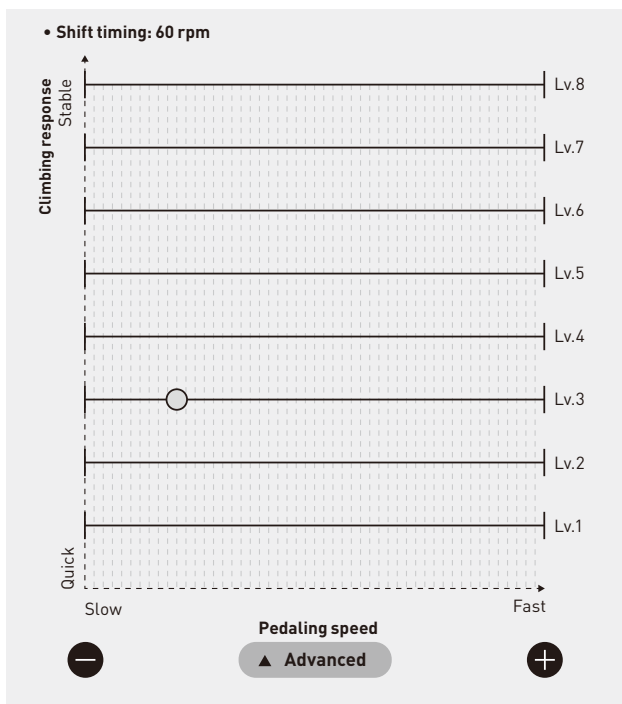

S T A B L E : AUTO SHIFT stability for technical climbing increases from Lv. 4 to 8

Lv.3 is the default AUTO SHIFT responsiveness setting

Q U I C K : Lv.1 and 2 increase AUTO SHIFT responsiveness for climbing

* Available with RD-M8150-11, RD-U6070, RD-U6050 & MU-UR510 (5-speed or 8-speed).

SHIMANO BATTERY PARTNERS

Battery service program for Shimano connected partners provides bike makers with a growing number of battery options to support the development of e-bikes with a wide range of uses. With system capacities ranging from 300 Wh up to a massive 900 Wh, bike makers have tremendous freedom to tailor capacity and form to each bike. We also offer a battery service program for select program members, that simplifies battery servicing with access to Shimano’s expansive service network.



Battery service program for Shimano connected partners



We introduced our battery service program for special service program members (Darfon and Trend Power) to make it easier for dealers and bike brands to handle battery servicing via our extensive Shimano service network.



SHIMANO STEPS SERVICE sticker

Compatible batteries have a special SHIMANO STEPS SERVICE sticker located on the device. Bike dealers can also check the battery’s model number in Shimano’s E-TUBE PROJECT to confirm program support.

Easy to spec

Bike makers can confidently select approved batteries that best match their desired build with the knowledge that they will be covered by our extensive Shimano service network.

Easy to service

Riders with an issue using a covered battery may be able to receive support from their local bike dealer. Using the Shimano service network, dealers can help get their customers back on their bikes as quickly and seamlessly as possible.

Bike dealers already know what to expect from the Shimano service network and will be able to improve their service contact and expect a faster turnaround with a simpler service flow.

Bike brands can also count on Shimano’s world-leading service support network with its well-established structure, support history, best practices, and standards.

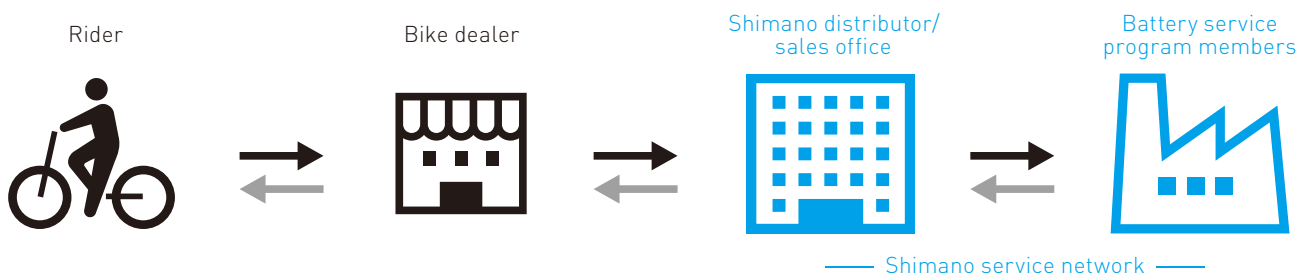

Easy to spot

Covered batteries can be identified by a special service logo on the device, a unique model number, and an identifier in the E-TUBE PROJECT App.

Option A: check the battery

Supported batteries have a special SHIMANO STEPS SERVICE logo on the device.

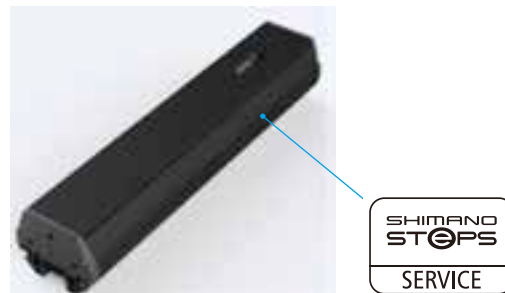

Option B: check E-TUBE PROJECT

Connect the bike to E-TUBE PROJECT for Windows (version 4.0.0). Supported batteries will have a blue "SUPPORTED BY SHIMANO" icon.



Shimano's battery service program is currently available in these areas



North and Central America

- Canada
- United States of America

Europe

- Andorra
- Austria
- Belgium
- Czech Republic
- Denmark
- Estonia
- Finland

- France
- Germany
- Hungary
- Iceland
- Ireland
- Italy
- Latvia

- Lithuania
- Luxembourg
- Malta
- The Netherlands
- Norway
- Poland
- Slovakia

- Spain
- Sweden
- Switzerland
- Turkey
- United Kingdom

SHIMANO

Smart Connect

E-TUBE

Shimano E-TUBE connects riders with their bikes through the latest technologies.

Download our free E-TUBE apps to enjoy a more innovative, convenient, and comfortable experience.



E-TUBE PROJECT

CUSTOMIZABLE SETTINGS OFF THE BIKE

- E-TUBE PROJECT Cyclist is a smartphone application for the customization and maintenance of each unit.
- E-TUBE PROJECT Professional is a Windows application for the customization and maintenance of each unit. Some functions may not be available when connected using the SM-PCE1/SM-BCR2.

Add pleasure to comfortable everyday rides in various riding conditions with customized e-bike settings

- AUTOMATIC SHIFTING allows the bike to adapt to changing terrain and select the ideal gear for you according to your settings in the app.
- City riding is made easier as the system automatically changes to your preferred gear while stopped, allowing a smooth and comfortable acceleration from intersections.



Visit a bike shop to get an accurate picture of your bike's condition, so enjoy riding for a long time to come.

- Evaluate and optimize battery performance based on your unique riding dynamics.
- Receive expert advice on how to manage personalized settings through E-TUBE PROJECT Cyclist.
- Regular scheduled maintenance will allow technicians to analyze system diagnostics and ensure optimum system performance for the life of your machine.



<https://bike.shimano.com/e-tube/project.html>



E-TUBE RIDE

FROM A SMARTPHONE TO THE CYCLING COMPUTER ON THE BIKE

Shimano's genuine application E-TUBE RIDE allows you to visualize your ride with a route map to your destination, a real time ride data display, and ride record data on your smartphone while you are on the bike. You can also upload your data to STRAVA.

STRAVA

Enhance your lifestyle and enjoy new discoveries on everyday rides.

Want to ride somewhere new?
Simply enter your location in the map and you'll be ready to explore!



<https://bike.shimano.com/e-tube/ride.html>

Enjoy greater peace of mind with the ability to check your bike's status on the go.

- Detailed battery status within the application provides cruising range for worry-free riding.
- Review distance remaining in the map function and optimize your performance according to your needs.
- Running late? Switch to BOOST mode and easily confirm the adjusted cruising range will get you to your destination on time.

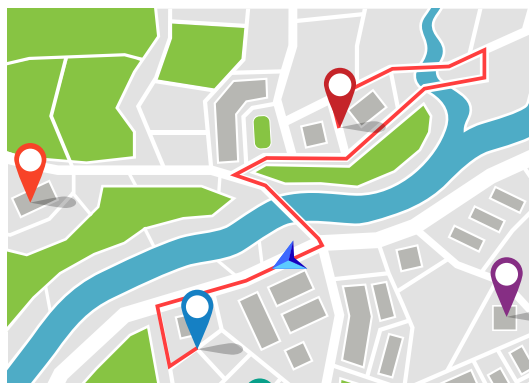

Choose Your Riding Style



COMFORT & UTILITY

Hassle-free
commuting and hauling

EP8

CARGO

EP6

CARGO

E6100 series



E5000 Series



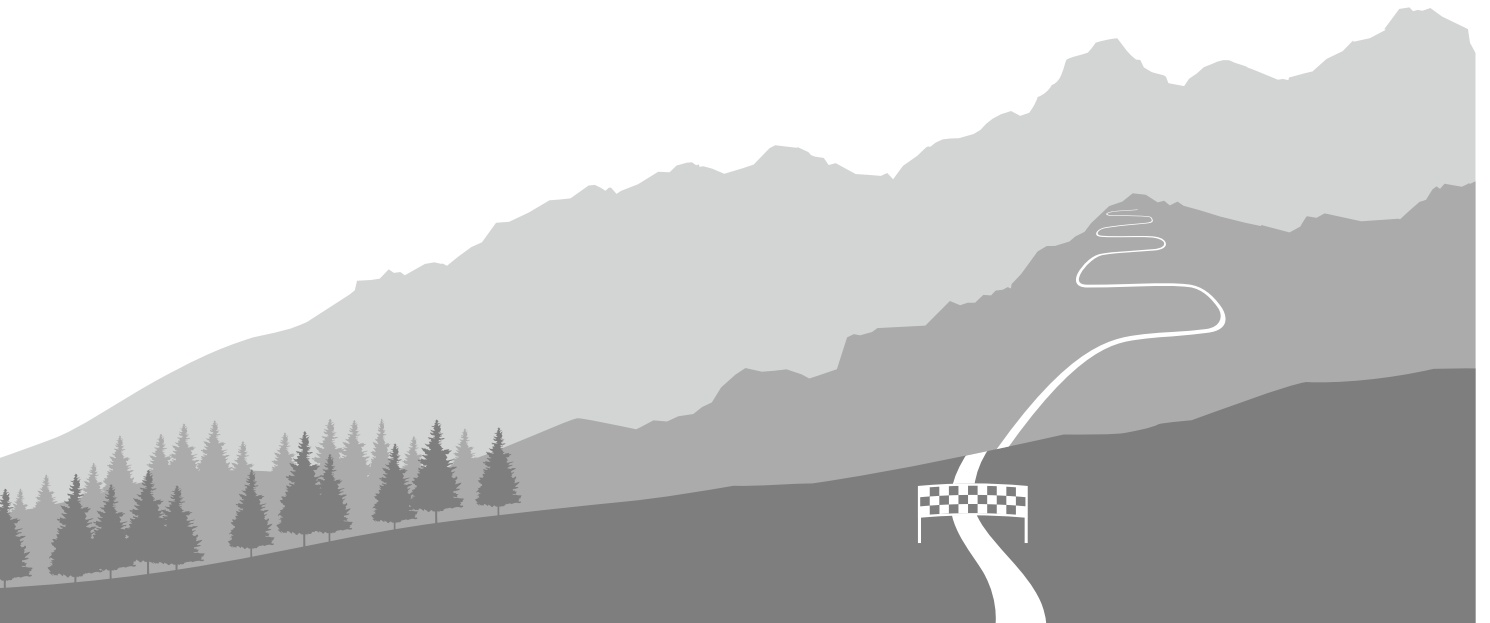

SPORTIVE

Sporty touring
and off-road
adventures

PERFORMANCE

Conquering mountains
and exploring new
trails

EP8



EP6



Browse your favorite bike brands

Shimano e-bike and e-MTB systems come equipped on a wide variety of bike brands. Browse your favorite at lifestylebike.shimano.com



<https://lifestylebike.shimano.com/>

Customize your ride

Shimano e-bike and e-MTB systems can be easily configured to suit your needs. Ask your dealer about the possibilities. And to customize your ride further – via Shimano E-TUBE apps – visit e-tubeproject.shimano.com



E-TUBE PROJECT Professional
<https://bike.shimano.com/e-tube/project/forwindows.html>



E-TUBE PROJECT Cyclist
<https://bike.shimano.com/e-tube/project/formobile.html>

Performance & Sportive

EXPLORE NEW GROUNDS

Ready to discover uncharted territory? Built on 35 years of pioneering innovation, our e-MTB systems are designed to let you manoeuvre your bike like a regular mountain bike. Blended harmoniously with the bike frame, the components work in sync to deliver unparalleled performance: powerful enough to tackle that steep, tricky bit of trail, yet intuitive enough to give you just the right amount of support to hit the technical single-tracks with confidence. They allow you to fully focus on what's ahead. So stop thinking and start exploring.

Equipped on 70+ mountainbike brands

You're guaranteed to find the perfect e-MTB to match your body, riding style and personal taste.



SHIMANO STEPS
EP801 PRODUCTS

EP8 | EP801



SHIMANO STEPS
EP600 PRODUCTS

EP6 | EP600



EP8

EP801 series



DU-EP801

DU-EP801

EP8 Drive Unit

- » Updated version of DU-EP800 with expanded system connectivity delivers evolved e-MTB performance and even greater value
- » Expanded system capabilities with CAN and ACC ports
- Natural and refined assist delivery from a light, quiet, and more compact motor with less pedaling drag
- New customization options and Finetune Mode with E-TUBE PROJECT
 - » Maximum torque: 85 N·m
 - » Lightweight magnesium body: 2.7 kg
 - » Only compatible with second-generation battery management system (BMS)
 - » US Class 3 compatible
- Delivers more consistent climbing speed and better-than-ever acceleration at higher cadences, which is excellent for pedaling out of corners.
 - » Maximum power output: 600 W

EP6

EP600 series



DU-EP600

DU-EP600

EP6 Drive Unit

- Updated version of DU-EP600 with expanded system connectivity delivers evolved e-MTB performance and even greater value
 - » Expanded system capabilities with CAN and ACC ports
- Natural and refined assist delivery from a light, quiet, and more compact motor with the same low pedaling drag as DU-EP801
- New customization options and Finetune Mode with E-TUBE PROJECT
 - » Maximum torque: 85 N·m
 - » Lightweight aluminum body: 3.0 kg
 - » Only compatible with second-generation battery management system (BMS)
 - » US Class 3 compatible

DRIVE UNIT OUTPUT FEATURE

Motor assist maximum torque/Rider pedaling input torque

EP801/EP600 Profile 1 (Shimano factory setting: BASIC MODE)(Rear derailleur specification)

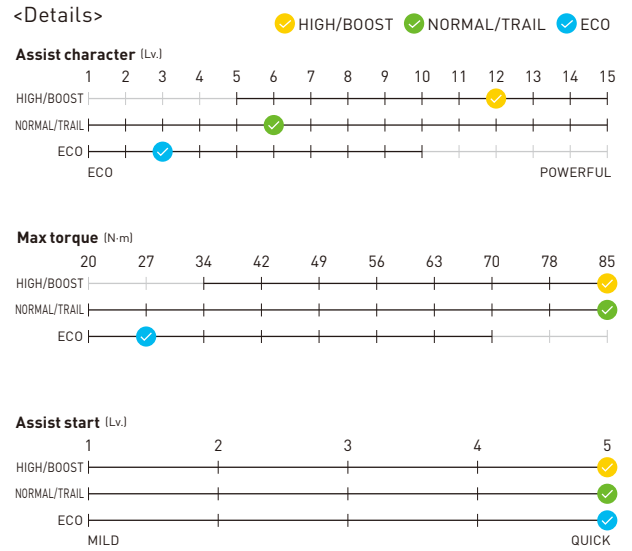
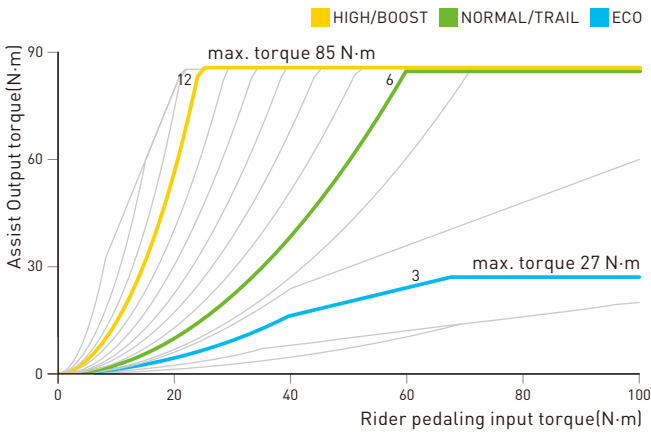

EP801/EP600 Profile 2 (Shimano Factory setting: FINE TUNE MODE)(Rear derailleur specification)

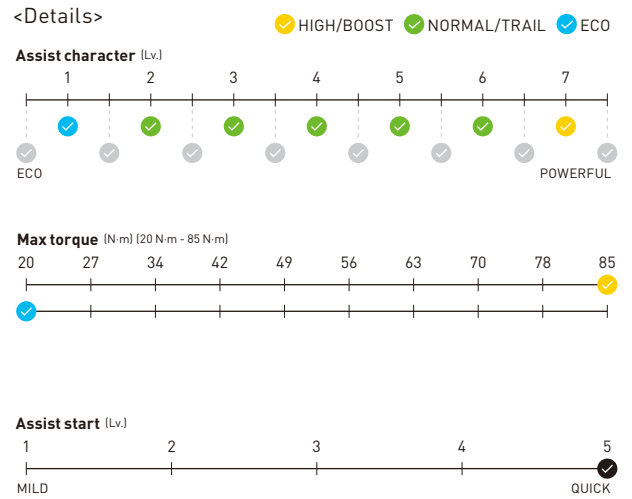
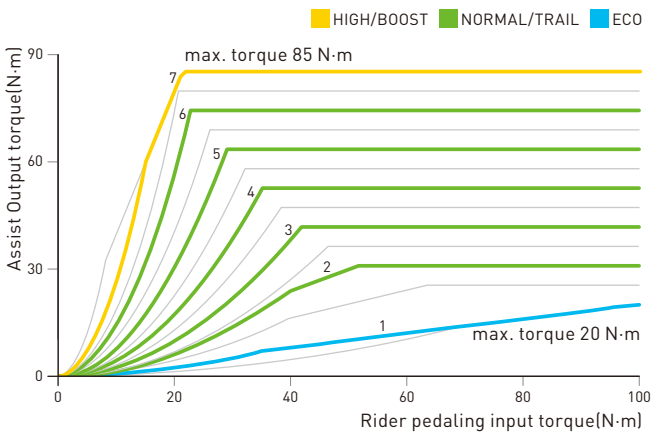

Note: Default level setting of each mode [BOOST, TRAIL, ECO] may vary depending on the settings chosen by each bike brand.

Technical Specifications

1 DU-EP600

EP6 Drive Unit

- Updated version of DU-EP600 with expanded system connectivity delivers evolved e-MTB performance and even greater value



EP600



EP801

1 DU-EP801

EP8 Drive Unit

- Updated version of DU-EP800 with expanded system connectivity delivers evolved e-MTB performance and even greater value



2 DC-EP801-A

EP8 Drive Unit Cover (Mount Bolt Exposed Type)

- Compact cover

2 DC-EP801-B

EP8 Drive Unit Cover (Mount Bolt Covered Type)

- Large cover



2 DC-EP801-G

EP8 Drive Unit Guard

- Guard cover for drive unit bottom



3 FC-EM900

SHIMANO STEPS E-BIKE HOLLOWTECH Crank Arm Set

- E-MTB dedicated cranks integrate more cleanly

3 FC-EM600

SHIMANO STEPS E-BIKE Crank Arm Set

- Aggressive MTB riding design

3 FC-M8150

SHIMANO DEORE XT HOLLOWTECH E-MTB Crank Arm Set

- New dedicated e-bike cranks integrate more cleanly with SHIMANO DEORE XT logo

4 SM-CRE80-12-SB

Chainring for E-MTB (12-speed)

- DYNAMIC CHAIN ENGAGEMENT+ with teeth shape to prevent chain drop



4 CR-EM800

SHIMANO STEPS Chainring 12-speed

- Chain line: 55 mm for O.L.D. 148 mm

4 SM-CRE80-12-B (55 mm, 53 mm)

SHIMANO STEPS E-MTB Chainring 12-speed

- DYNAMIC CHAIN ENGAGEMENT+



4 SM-CRE70-12

SHIMANO STEPS Chainring 12-speed

4 SM-CRE80-B (55 mm, 53 mm)

SHIMANO STEPS Chainring 10/11-speed

- DYNAMIC CHAIN ENGAGEMENT

4 SM-CRE80/-R**SHIMANO STEPS Chainring 10/11-speed**

- Adapt to 142 mm E-THRU O.L.D. along with 50 mm chainline

4 SM-CRE70**SHIMANO STEPS Chainring 9/10/11-speed**

- Chainline 50 mm

**4 CD-EM800/
CD-EM800 w/o plate****SHIMANO STEPS Chain Device 11/12-speed**

- Helps ensure chain stability and avoid chain drop through rough sections of trail

4 SM-CDE80**SHIMANO STEPS Chain Device**

- Chain management

**5 SW-M8150-R/SW-M8150-IR****SHIMANO DEORE XT Di2 Right Shift Switch/I-SPEC EV**

- Easy and intuitive access lever with short stroke for quick and responsive operation

5 SW-EN600-L**SHIMANO STEPS Left Switch Unit for Assist**

- Simple and intuitive button operation

5 SW-EM800-L**EP8 Left Switch Unit for Assist**

- Improved ergonomics

6 SC-EN600**SHIMANO STEPS Cycle Computer**

- Customizable data dashboards let you select four riding metrics per screen with the E-TUBE PROJECT APP

6 SC-EN610**SHIMANO STEPS Cycle Computer**

- Customizable data dashboards let you select four riding metrics per screen with the E-TUBE PROJECT APP

5 SC-EN500**SHIMANO STEPS Cycle Computer with Assist Switch (SD300 port)**

- Integrated single unit for more attractive and affordable City/Trekking e-bikes

7 BT-EN806**SHIMANO STEPS Integrated Type Battery for Down Tube (630 Wh)**

- Capacity: 630 Wh (36 V, 17.5 Ah)

7 BT-EN805-L**SHIMANO STEPS Integrated Type Battery for Down Tube (504 Wh)**

- Capacity: 504 Wh (36 V, 14 Ah)

7 BT-EN805**SHIMANO STEPS Integrated Type Battery for Down Tube (504 Wh)**

- Capacity: 504 Wh (36 V, 14 Ah)

8 EW-CP100**SHIMANO STEPS Satellite Charging Port for E-Bike**

- Compact, semi-integrated frame charging port

9 EW-SW310**SHIMANO STEPS Satellite System On/Off Switch (SD300)**

- Pair with SW-EM800 and EW-SW310 for a simple e-MTB cockpit

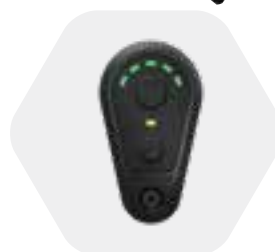

EP8 | EP800



SHIMANO
STEPS | E7000



DRIVE UNIT OUTPUT FEATURE

Motor assist maximum torque/Rider pedaling input torque

(EP800 -Shimano factory setting Profile 1)

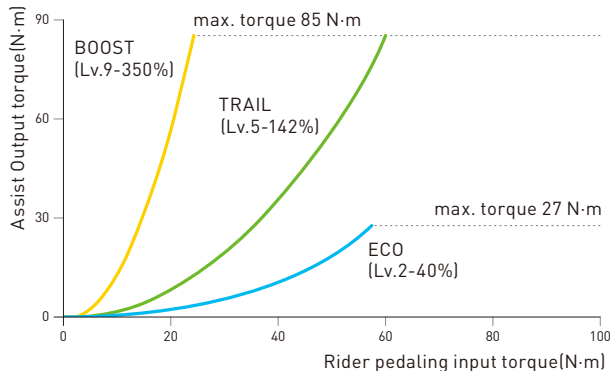

(EP800 -Shimano factory setting Profile 2)

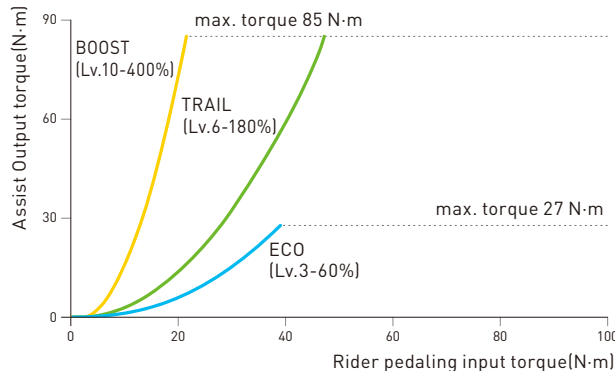

Shimano factory setting (Profile 1) details:

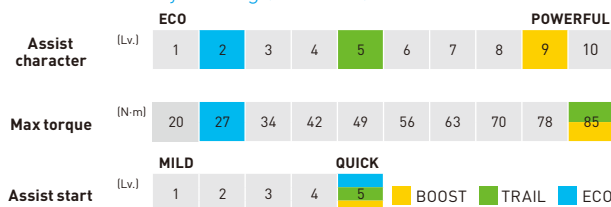

Shimano factory setting (Profile 2) details:

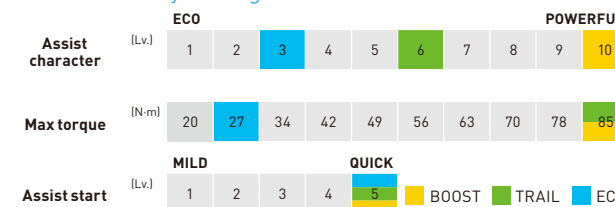

Note: Default level setting of each mode [BOOST, TRAIL, ECO] may vary depending on the settings chosen by each bike brand.

E7000

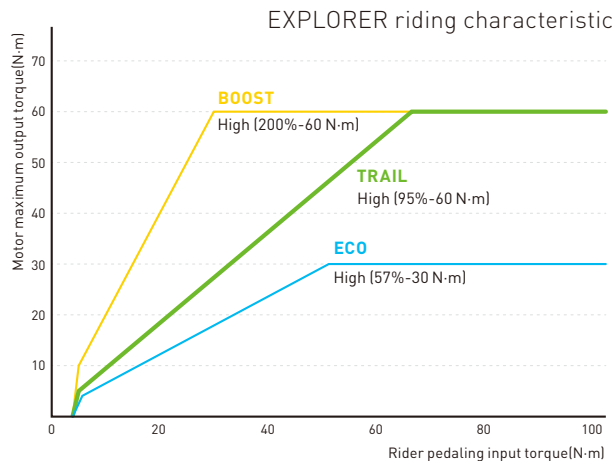
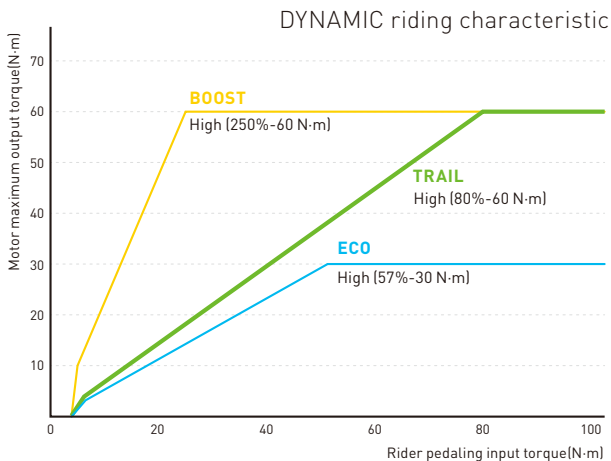

Riding characteristics variation set by E-TUBE PROJECT application

√=Yes *Choose one riding characteristic in this mode

Model		EP800	
Profile		Profile 1	Profile 2
Assist character	BOOST	Lv.9-350%	Lv.10-400%
	TRAIL	Lv.5-142%	Lv.6-180%
	ECO	Lv.2-40%	Lv.3-60%
Max torque	BOOST	85 N·m	85 N·m
	TRAIL	85 N·m	85 N·m
	ECO	27 N·m	27 N·m
Assist start	BOOST	Lv.5	Lv.5
	TRAIL	Lv.5	Lv.5
	ECO	Lv.5	Lv.5

Assist mode	Riding characteristic level [* Set by E-TUBE PROJECT]	E7000			
		Assist ratio	Riding Characteristic		
			Dynamic	Explorer	Customize
BOOST	High	250%, 60 N·m	√	-	*√
	Medium	200%, 60 N·m	-	√	
	Low	150%, 60 N·m	-	-	
TRAIL	High	110%, 60 N·m	-	-	*√
	Medium	95%, 60 N·m	-	√	
	Low	80%, 60 N·m	√	-	
ECO	High	57%, 30 N·m	√	√	*√
	Medium	38%, 30 N·m	-	-	
	Low	19%, 30 N·m	-	-	

Technical Specifications

1 DU-E7000

SHIMANO STEPS E7000 Drive Unit for V-BRAKE, Disc Brake

- Compact drive unit

1 DU-EP800

EP8 Drive Unit

- Pure trail focus

2 DC-EP800-A/B/G

EP8 Drive Unit Cover (Mount Bolt Exposed Type)/(Mount Bolt Covered Type)/EP8 Drive Unit Guard

- Aggressive MTB riding design

3 FC-M8150

SHIMANO DEORE XT HOLLOWTECH E-MTB Crank Arm Set

- New dedicated e-bike cranks integrate more cleanly with SHIMANO DEORE XT logo

3 FC-EM900

SHIMANO STEPS E-BIKE HOLLOWTECH Crank Arm Set

- E-MTB dedicated cranks integrate more cleanly

3 FC-EM600

SHIMANO STEPS E-BIKE Crank Arm Set

- Aggressive MTB riding design

3 FC-E8050/FC-E8000

SHIMANO STEPS E8000 HOLLOWTECH MTB E-BIKE Crankset/MTB E-BIKE Crankset

- E-MTB dedicated crank set

3 FC-M8050

SHIMANO DEORE XT HOLLOWTECH MTB E-BIKE Crank Arm Set

- E-MTB dedicated crank set

4 SM-CRE70-12

SHIMANO STEPS Chainring 12-speed

- Chain line 50 mm



EP800



E7000



4 SM-CRE70-12-B [55 mm, 53 mm]

SHIMANO STEPS Chainring 12-speed

4 SM-CDE70

SHIMANO STEPS Chain Device

- Support stable riding performance

4 SM-CRE80-12-B [55 mm, 53 mm]

SHIMANO STEPS E-MTB Chainring 12-speed

- DYNAMIC CHAIN ENGAGEMENT+





4 CD-EM800

SHIMANO STEPS Chain Device 11/12-speed

- Helps ensure chain stability and avoid chain drop through rough sections of trail



5 SW-E7000-R/L

SHIMANO STEPS E7000 Right Switch Unit for SEIS Shift/Left Switch Unit for Assist

- Easy, simple operation



5 SW-EM800-L

EP8 Left Switch Unit for Assist

- Improved ergonomics



6 SC-E7000

SHIMANO STEPS E7000 Cycle Computer

- Assist mode



6 SC-EM800

EP8 Cycle Computer

- Compact and low-profile MTB design



7 BT-E8010/BT-E8014

SHIMANO STEPS Battery for Down Tube (504 Wh)/(418 Wh)

- MTB dedicated design



7 BT-E8016

SHIMANO STEPS Battery for Down Tube (630 Wh)

- Compact and low-center of gravity



7 BT-E8035

SHIMANO STEPS Integrated Type Battery for Down Tube (504 Wh)

- High level of water-resistant performance (IPX5)



7 BT-E8036

SHIMANO STEPS Integrated Type Battery for Down Tube (630 Wh)

- Supports sleek frame design



7 BT-E8020

SHIMANO STEPS Integrated Type Battery for Down Tube (504 Wh)

- MTB dedicated design

8 EW-SD300

Electric Wire SD300 for External Routing

- More compact design makes new electric components smaller and lighter

9 EW-SW300

SHIMANO STEPS SD300 Satellite System On/Off Switch

- Compact, semi-integrated frame satellite switch

Drive unit, Drive unit cover, Drive unit guard

EP8

EP801 series



DU-EP801



DU-EP801

EP8 Drive Unit

- » Updated version of DU-EP800 with expanded system connectivity delivers evolved e-MTB performance and even greater value
- » Expanded system capabilities with CAN and ACC ports
- Natural and refined assist delivery from a light, quiet, and more compact motor with less pedaling drag
- New customization options and Finetune Mode with E-TUBE PROJECT
 - » Maximum torque: 85 N-m
 - » Lightweight magnesium body: 2.7 kg
 - » Only compatible with second-generation battery management system (BMS)
 - » US Class 3 compatible
- Delivers more consistent climbing speed and better-than-ever acceleration at higher cadences, which is excellent for pedaling out of corners.
 - » Maximum power output: 600 W



DC-EP801-A
Drive Unit Cover
(Mount Bolt Exposed Type)



DC-EP801-B
Drive Unit Cover
(Mount Bolt Covered Type)



DC-EP801-G
Drive Unit Guard

EP6

EP600 series



DU-EP600



DU-EP600

EP6 Drive Unit

- Updated version of DU-EP600 with expanded system connectivity delivers evolved e-MTB performance and even greater value
- » Expanded system capabilities with CAN and ACC ports
- Natural and refined assist delivery from a light, quiet, and more compact motor with the same low pedaling drag as DU-EP801
- New customization options and Finetune Mode with E-TUBE PROJECT
 - » Maximum torque: 85 N-m
 - » Lightweight aluminum body: 3.0 kg
 - » Only compatible with second-generation battery management system (BMS)
 - » US Class 3 compatible

Drive unit

√=Yes

Model no.		DU-EP801	DU-EP600
Output characteristics		MTB	MTB
Continuous rated power (Watt)		250	250
Maximum torque (N·m)		85	85
Compatible brake type		Disc brake	Disc brake
Drive unit chain device		CD-EM800 SM-CDE80/70	CD-EM800 SM-CDE80/70
Chain case		√	√
Drive unit cover design		DC-EP801-A/B	DC-EP801-A/B
Chain line (mm)		50/53/55/56.5	50/53/55/56.5
Maximum support bike speed	25 km/h	√	√
	20 mph	√	√
	28 mph	√ US Class3 (comply with California) only	√ US Class3 (comply with California) only
	Adjustment	-	-
Assist mode		Boost, trail, eco High, normal, eco	Boost, trail, eco High, normal, eco
Walk assist function*	On/off (Set by E-TUBE PROJECT)	√	√
	Intelligent	√ (In case of Di2)	√ (In case of Di2)
	Quick	√	√
Power supply for front light/rear light		DC 12 V	DC 12 V
Maximum current supply front and rear light total (A)		2.0	2.0
Power supply and maximum current for ACC		12 V DC/2.0 A	12 V DC/2.0 A
Power supply and maximum current for CAN port		12 V DC/2.0 A	12 V DC/2.0 A
Safe way home function		√	√
Port for speed sensor (1 pc)		SD300 type	SD300 type
Torque sensor		√	√
Crank arm position sensor		√	√
Bike speed sensor		EW-SS300/SS301/SS302	EW-SS300/SS301/SS302
Cadence sensor		√	√
Weight (kg) w/o cover		2.7	3.0

Drive unit cover, Drive unit guard

√=Yes

Model no.		DC-EP801-A	DC-EP801-B	DC-EP801-G
Cover	Right	-	-	-
	Left	√	√	-
	Bottom	-	-	√
Available DU angle (deg.)		0 - 60	0 - 60	0 - 60
Note		-	-	-

* The walk assist mode function may not be able to be used in certain regions. (Singapore, Brazil)

Drive unit, Drive unit cover, Drive unit guard

EP8

EP800 series



DU-EP800
Drive Unit



DC-EP800-A
Drive Unit Cover
(Exposed Mounting
Screw Type)



DC-EP800-B
Drive Unit Cover
(Covered Mounting
Screw Type)



DC-EP800-G
Drive Unit Guard

E7000 series



DU-E7000
Drive Unit for V-BRAKE, Disc Brake



SM-DUE70-A
Drive Unit Cover



SM-DUE70-B
Drive Unit Cover
(Exposed Mounting
Screw Type)

Drive unit

√=Yes

Model no.		DU-EP800	DU-E7000
Output characteristics		MTB	MTB
Maximum rated power (Watt)		250	250
Maximum torque (N·m)		85	60
Maximum power output (W)		500	500
Compatible brake type		Disc brake	Disc brake, V-BRAKE
Compatible BB type		24 mm axle serration	24 mm axle serration
Cable connector		Left side	Right side
Drive unit chain device		CD-EM800 SM-CDE80/70	CD-EM800 SM-CDE80/70
Chain case		-	-
Drive unit cover design		DC-EP800-A/B	E7000 (SM-DUE70A/B)
Chain line (mm)		50/53/56.5	50/53
Q-factor		177 mm	180 mm
 Di2 compatible	INTER-11	√	-
	INTER-8	√ Automatic available	-
	INTER-7	-	-
	INTER-5	√ Automatic available	-
	Deraillleur type	√	√
Maximum support bike speed	25 km/h	√	√
	20 mph	√	√
	28 mph	-	-
	Adjustable (15 km-25 km, 12-20 mph setting by E-TUBE PROJECT)	√	√
Assist mode		Boost, trail, eco	Boost, trail, eco
Walk assist function*	On/off (Set by E-TUBE PROJECT)	√	√
	Intelligent	√ (In case of Di2)	√ (By using SM-DUE10/SM-DUE11)
Power supply for front light/rear light		DC 12 V	DC 12 V
Maximum current supply front and rear light total (A)		2.0	2.0
Power supply and maximum current for ACC		-	-
Power supply and maximum current for CAN port		-	-
Safe way home function		√	√
Port for speed sensor (1 pc)		SD300 type	SD50 type
Torque sensor		√	√
Crank arm position sensor		√	√
Bike speed sensor		EW-SS300/SS301	SM-DUE10/DUE11
Cadence sensor		√	√
Weight (kg) w/o cover		2.6	2.79

Drive unit cover, Drive unit guard

√=Yes

Model no.		DC-EP800-A	DC-EP800-B	DC-EP800-G	SM-DUE70-A	SM-DUE70-B
Cover	Right	-	-	-	√	√
	Left	√	√	-	√	√
	Bottom	-	-	√	-	-
Available DU angle (deg.)		0 - 60	0 - 60	0 - 60	0 - 60	0 - 60
Note		-	-	-	-	-

* The walk assist mode function may not be able to be used in certain regions. (Singapore, Brazil)

Cycle computer



SC-EM800
Cycle Computer
D-FLY
ANT



SC-EN610
Cycle Computer



SC-EN600
Cycle Computer

Model no.		SC-EM800	SC-EN610	SC-EN600	SC-EN500	SC-E7000
Battery management system compatibility	2nd gen.	√	√	√	√	-
	1st gen.	*√	-	-	-	√
Mount position	Center on handlebar	-	√	-	-	-
	Right on handlebar	√	-	√	-	√
	Others	-	-	*√	*√	-
Wireless system		ANT private Bluetooth®LE	-	-	-	ANT private Bluetooth®LE
E-TUBE port		SD300 type (4 pcs)	SD300 type (3 pcs)	SD300 type (3 pcs)	SD300 type (1 pcs)	SD50 type (4 pcs)
Back light		√	√	√	√	√
LCD size (inch)		1.6	2.8	1.6	1.4	1.39
Beep		√	√	-	-	√
Display detachable		-	√	-	-	-
Display fixation		√	-	√	√	√
Display change button		√	-	-	√	√
Assist mode change (w/o switch unit)		√	-	-	√	√
Reset button		-	-	-	-	-
Inside battery		√	-	-	-	√
System on/off button		-	-	-	√	-
Light on/off button		-	-	-	√	-
Assist up/down button		-	-	-	√	-
Auto start & auto stop		-	-	-	-	-
Contents of display	Clock	√	√	√	-	√
	Assist mode display	√	√	√	√	√
	Assist on/off	√	√	√	-	√
	Walk mode display*	√	√	√	√	√
	Battery charge level	√	√	√	√	√
	Light condition	√	√	√	-	-
	Current speed	√	√	√	√	√
	Gear position display	**√	√	√	√	√
	Start mode	-	√	√	-	√
	Automatic shift mode	**√	√	√	√	√
	Maximum speed	√	√	√	-	**√
	Average speed	√	√	√	-	**√
	Trip distance	√	√	√	√	√
	Trip time	√	√	√	-	**√
Odometer	√	√	√	√	√	

* The walk assist mode function may not be able to be used in certain regions. (Singapore, Brazil)



SC-EN500
Cycle Computer with Assist Switch
(SD300 port)



SC-E7000
Cycle Computer
D-FLY Bluetooth®
ANT

V=Yes

Model no.		SC-EM800	SC-EN610	SC-EN600	SC-EN500	SC-E7000
Contents of display	Estimated range	√	√	√	√	√
	Range overview	√	-	-	-	-
	Assist power indicator	√	√	√	-	-
	Error message	√	√	√	√	√
	Cadence (rpm)	√	√	√	-	**√
	Shifting advice	-	-	-	-	-
	Maintenance alert	√	√	√	***√	√
	Bluetooth®LE connection status	√	√	√	-	√
Setting menu	Assist profile	-	√	-	-	-
	Trip distance reset	√	√	√	√	√
	Odometer reset	√	-	-	-	-
	Setting clear	√	√	√	-	-
	Clock adjustment	√	√	√	-	√
	Start mode	-	√	√	***-	√
	Shifting advise	-	√	-	-	-
	Back light on/off	√	√	√	***-	-
	Light on/off	***√	√	√	***-	√
	Back light brightness	√	√	√	-	-
	Beep on/off	√	√	-	-	√
	Unit (km/mile)	√	√	√	**√	√
	Font color	-	-	-	-	√
	Adjusting for shift	**√	√	√	***-	*√
	Adjusting for auto shift timing	-	√	-	***-	*√
	RD protection reset	**√	-	-	-	*√
	Bluetooth®LE pairing	√	√	√	-	√
Bluetooth®LE/ANT connection status	-	-	-	-	-	
Assist customize	√	-	-	-	-	
Language	English/german/dutch/french/spanish/italian	English/german/dutch/french/spanish/italian	English/german/dutch/french/spanish/italian	English	English/german/dutch/french/spanish/italian	
Note	2 spec of clamp band diameter 31.8 and 35.0 mm. * Need to update new firmware ** In case of Di2 *** In combination with assist mode switch	Handlebar diameter: 25.4, 31.8 and 35.0 mm (3 spec) Display contents are customized by E-TUBE PROJECT	2 spec of clamp band diameter 31.8 and 35.0 mm. * Integrated specification display contents are customized by E-TUBE PROJECT	* Left on handlebar (normal specification and I-SPEC EV specification) ** Setting by E-TUBE PROJECT *** Drive unit setting by E-TUBE PROJECT	* In case of SEIS ** Option by E-TUBE PROJECT	

Switch unit, Shifting switch

SW-EN600-L
Left Switch Unit for Assist



SW-EN600-R
Right Switch Unit for Shifting



SW-EM800-L
Left Switch Unit for Assist



SW-E7000-L
Left Switch Unit for Assist



SW-E7000-R
Right Switch Unit for SEIS Shift



SW-M8150-R
Di2 Right Shift Switch



SW-M8150-IR
Di2 Right Shift Switch



SW-M8050-L
Di2 Left Shift Switch





Switch unit

V=Yes

Model no.		SW-EM800-L	SW-EN600-L	SW-EN600-R	SW-E7000-L	SW-E7000-R
Battery management system compatibility	2nd gen.	√	√	√	-	-
	1st gen.	*√	-	-	√	√
Switch type		-	-	-	-	-
Usage		For assist	For assist	For SEIS shift	For assist	For SEIS shift
Electric wire removable		√	√	√	-	-
Firmware update by E-TUBE PROJECT		√	√	√	√	√
Electric wire port	SD50 type (pc)	0	-	-	0	0
	SD300 type (pc)	1	1	1	0	0
Electric wire connector	SD50 type (pc)	0	-	-	1	1
	SD300 type (pc)	0	-	-	0	0
Assist mode change		√	√	-	√	-
Display change		-	√	-	-	-
Automatic/manual change		-	-	√	-	√
Light on-off		-	√	-	*-	-
Multiple input	2 step	-	-	-	-	-
	Hold	**√	-	*√	*√	*√
Note		* Need to update new firmware ** Set by E-TUBE PROJECT	-	* Available for rear derailleur	* Set by E-TUBE PROJECT	* Available for rear derailleur

Shifting switch

V=Yes

Series				
Model no.	SW-M8150-R	SW-M8150-IR	SW-M8050-L	
Switch type	Adjustable lever position	Adjustable lever position	FIREBOLT	
Position	Clamp band	I-SPEC EV	Clamp band, left	
Compatible electric wire	EW-SD300	EW-SD300	EW-SD50	
Switch QTY	3	3	2	
SD50 port (pcs)	0	0	1	
SD300 port (pcs)	1	1	0	
SD50 connector (pcs)	0	0	0	
SD300 connector (pcs)	0	0	0	
Multiple input	2 step	-	-	
	Hold	√	√	-*(√)
Suspension switch		-	-	-**(√)
Mount position adjust		√	√	√
Master unit		-	-	-
Firmware update by E-TUBE PROJECT		√	√	√
Note		-	-	* User can use it for rear derailleur multishift ** User can use it for suspension control

Crank arm



FC-M8150
HOLLOWTECH E-MTB Crank Arm Set



FC-EM900
E-bike HOLLOWTECH Crank Arm Set



FC-EM600
E-bike Crank Arm Set



FC-M8050
HOLLOWTECH MTB E-bike Crank Arm Set



FC-E8050
HOLLOWTECH MTB E-bike Crankset



FC-E8000
MTB E-bike Crankset

E-bike crank arm and drive unit compatibility

<p>EP8/EP6 Drivetrain system</p>	<p>DU-EP800 DU-EP801 DU-EP600</p>	<p>FC-EM900 FC-M8150 FC-EM600 Solid type</p>
<p>No compatibility between the current model and DU/FC</p>		
<p>E8000/E7000 Drivetrain system</p>	<p>DU-E8000 DU-E7000</p>	<p>FC-M8050 FC-E8050 FC-E8000 Solid type</p>

Chain device



CD-EM800 (56.5, 55, 53 mm)
Chain Device



CD-EM800 w/o plate (55 mm)
Chain Device





SM-CDE80
Chain Device



SM-CDE70
Chain Device

Crank arm

√=Yes

Brand		SHIMANO	SHIMANO		SHIMANO	SHIMANO	
Model no.	FC-M8150	FC-EM900	FC-EM600	FC-M8050	FC-E8050	FC-E8000	
Crank arm type		√	√	-	√	√	-
	Solid	-	-	√	-	-	√
Q factor (mm)	177	177	177	177, 180*	177, 180*	177, 180*	
BB type	24 mm axle serration	24 mm axle serration	24 mm axle serration	24 mm axle serration	24 mm axle serration	24 mm axle serration	
Crank arm length (mm)	160 mm	√	√	√	-	-	√
	165 mm	√	√	√	√	-	√
	170 mm	√	√	√	√	√	√
	175 mm	√	√	√	√	√	√
Compatible drive unit	EP801/EP600/EP800	EP801/EP600/EP800	EP801/EP600/EP800	E8000/E7000/E6100/E6110	E8000/E7000/E6100/E6110	E8000/E7000/E6100/E6110	
Note	-	-	-	* In case with DU-E6100/E6110/E6180/E7000	* In case with DU-E6100/E6110/E6180/E7000	* In case with DU-E6100/E6110/E6180/E7000	

Chain device

√=Yes

Model no.	CD-EM800	CD-EM800 w/o plate	SM-CDE80	SM-CDE70	
Chain line (mm)	56.5	√	√	-	-
	55	√ *	√	-	-
	53	√	√	√ (w/ plate type) √ (w/o plate type)	√
	50	-	-	- (w/ plate type) √ (w/o plate type)	-
Chain compatibility	12-speed	√	√	√	√
	11-speed	√	√	√	√
	10-speed	-	-	√	√
	9-speed	-	-	-	√
Top gear teeth	38T	√	-	√	√
	36T	√	-	√	√
	34T	√	-	√	√
	32T	-	√	-	-
	30T	-	√	-	-
Assumed rear sprocket teeth	11-36T	-	-	√	√
	11-40T	√	√	√	√
	11-42T	√	√	√	√
	11-46T	√	√	√	√
	11-50T	√	√	-	-
	10-45T	√	√	√	√
	10-51T	√	√	√	√
Others	-	-	-	-	
Direct mount to drive unit	√	-	√ (w/ plate type) - (w/o plate type)	√	
Compatible drive unit	DU-EP801, DU-EP800, DU-EP600, DU-E8000, DU-E8080, DU-E7000	DU-EP801, DU-EP800, DU-EP600, DU-E8000, DU-E8080, DU-E7000	DU-EP800, DU-E8000, DU-E8080, DU-E7000	DU-EP800, DU-E8000, DU-E8080, DU-E7000	
Rear suspension stroke (mm)	0 - 170	0 - 170	0 - 170	0 - 170	
Note	w/ plate * Need special CD-EM800 only for 55 mm chain line	w/o plate	w/ plate, w/o plate type are available	w/ plate	

Chainring



SM-CRE80-12-SB
Chainring for E-MTB (34T)



CR-ET600
Chainring (44T)



CR-EM800
Chainring for E-MTB (32T)



SM-CRE70-12
Chainring (42T)



SM-CRE80-12-B
Chainring for E-MTB (34T)



SM-CRE80
Chainring (44T)

Chainring

√=Yes

Speed		12-speed					10/11-speed		
Model no.		CR-EM800	SM-CRE80-12-SB	SM-CRE80-12-B	SM-CRE70-12-B	SM-CRE70-12	SM-CRE80-B	SM-CRE80-R	SM-CRE80
Chain line	56.5 mm	-	√	-	-	-	-	-	-
	55 mm	√	-	√	√	-	√	-	-
	53 mm	-	-	√	√	-	√	-	-
	50 mm	-	-	-	-	√	-	√	√
Chainring teeth	32T	√	-	-	-	-	-	-	-
	34T	-	√	√	-	-	√	-	√
	36T	-	√	√	√	-	-	-	-
	38T	-	-	√	-	-	√	-	√
	42T	-	-	-	-	√	-	-	-
	44T	-	-	-	-	-	-	-	√
	47T	-	-	-	-	-	-	√	-
 DYNAMIC CHAIN ENGAGEMENT		√	√	√	-	-	√	-	√ (38T, 34T)
Chainring material		Steel	Steel	Steel	Steel	Steel	Steel	Aluminum	Steel
Chain guard type	Double	-	-	-	-	√	-	-	√*
	Single	-	-	-	-	-	-	-	-
	w/o CG	√	√	√	√	-	√	√	√
Chain device compatible		√	√	√	√	-	√	SM-CDE80 (frame mount)	√
Chain case compatible		-	-	-	-	-	-	-	-

√=Yes

Speed		9/10/11-speed		
Model no.		CR-ET600	SM-CRE70	SM-CRE70-B
Chain line	56.5 mm	-	-	-
	55 mm	-	-	√
	53 mm	-	-	√
	50 mm	√	√	-
Chainring teeth	32T	-	-	-
	34T	-	-	√
	36T	-	-	-
	38T	√	√	-
	42T	-	-	-
	44T	√	-	-
	47T	-	-	-
 DYNAMIC CHAIN ENGAGEMENT		-	-	-
Chainring material		Steel	Steel	Steel
Chain guard type	Double	√	√	-
	Single	√	-	-
	w/o CG	√	√	√
Chain device compatible		-	√ w/o CG, w/o back plate	√
Chain case compatible		√	-	-

Comfort & Utility

EASY RIDER

Say goodbye to crowded trains or trams and glide past queues of cars at the traffic lights, effortlessly taking off when they turn green. Or explore the great outdoors and rediscover nature – without worrying about hills or headwinds. The refined power assistance gives you the same natural riding feeling as a regular bike but will keep you cool and ensure you arrive at your destination on time – fresh and de-stressed.





SHIMANO STEPS
E6100/E5000 PRODUCTS

SHIMANO
STEPS | E6100



SHIMANO
STEPS | E5000



DRIVE UNIT OUTPUT FEATURE

Motor assist maximum torque/Rider pedaling input torque

E6100

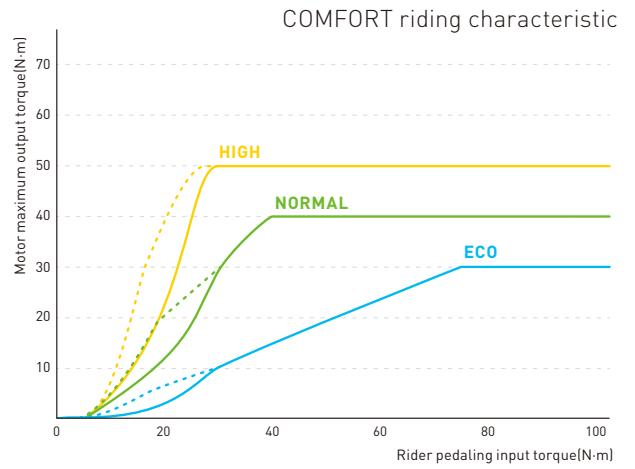
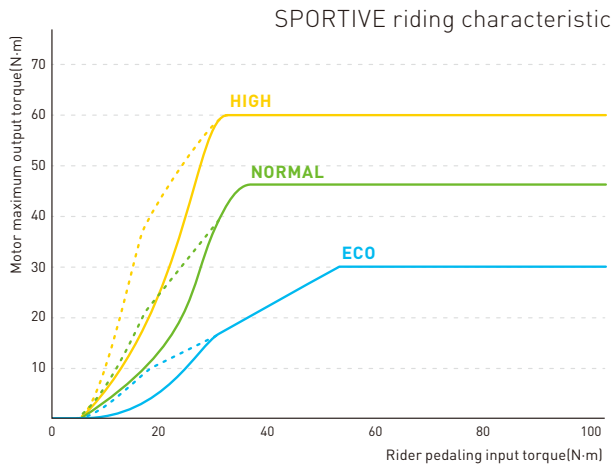

E5000

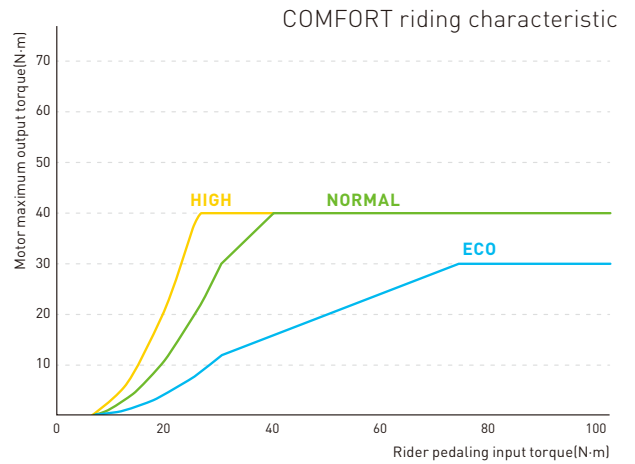
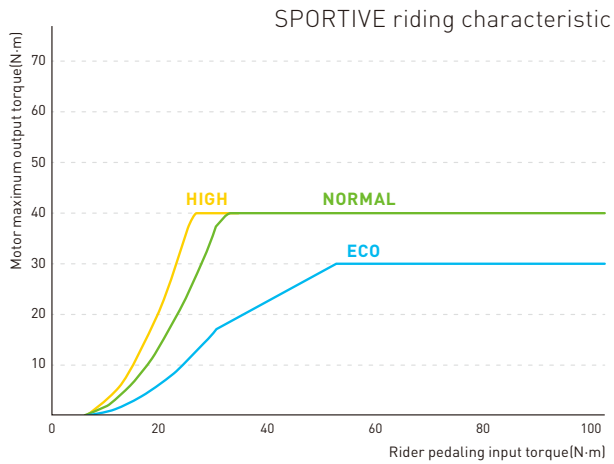

Assist characteristics variation set by E-TUBE PROJECT application

Model		E6100		E5000	
Riding characteristic level (* Set by E-TUBE PROJECT)		Sportive	Comfort	Sportive	Comfort
Maximum torque		60 N·m	50 N·m	40 N·m	40 N·m
Shifting system	INTER-5E	60 N·m	50 N·m	40 N·m	40 N·m
	IHG type (except INTER-5E)	50 N·m	50 N·m	40 N·m	40 N·m
	RD type	60 N·m	50 N·m	40 N·m	40 N·m
Assist mode	HIGH	200%	200%	200%	200%
	NORMAL	125%	100%	125%	100%
	ECO	60%	40%	60%	40%

Technical Specifications

1 DU-E5000

SHIMANO STEPS E5000 Drive Unit for V-BRAKE, Roller Brake, Disc Brake, Coaster Brake

- Easy to access cable terminal without removing chainring and chain case



1 DU-E6100

SHIMANO STEPS E6100 Drive Unit for V-BRAKE, Roller Brake, Disc Brake

- Easy to access cable terminal without removing chainring and chain case



1 DU-E6110

SHIMANO STEPS E6100 Drive Unit for Coaster Brake

- Integrated drivetrain and assist



2 SM-CRE50

SHIMANO STEPS E5000 Chainring

- Symmetric and narrower Q-factor design than current E6000 series



2 SM-CRE61

SHIMANO STEPS E6100 Chainring

- Without chainguard type: Silver, Black color



3 FC-E5000

SHIMANO STEPS E5000 E-BIKE Crankset

- Normalization and unification of chain line for various system



3 FC-E6100

SHIMANO STEPS E6100 E-BIKE Crankset

- Optimized pedaling environment





4 SW-E7000

SHIMANO STEPS E7000 Left Switch Unit for Assist/Right Switch Unit for SEIS Shift

- Easy, simple operation

4 SW-E6010

SHIMANO STEPS E6000 Left Switch Unit for Assist/Right Switch Unit for SEIS Shift

- Attractive styling

5 SC-E5003

SHIMANO STEPS Cycle Computer with Assist Switch (SD300 port)

- Unified switch and display

5 SC-E6100

SHIMANO STEPS E6100 Cycle Computer

- Assist mode

5 SC-E5000

SHIMANO STEPS Cycle Computer with Assist Switch

- Unified switch and display

6 EW-EN100

SHIMANO STEPS Junction A for E-BIKE

- Assist mode (w/o cycle computer)

7 BT-E8020

SHIMANO STEPS Integrated Type Battery for Down Tube (504 Wh)

- MTB dedicated design

8 BT-E8010/BT-E8014

SHIMANO STEPS Battery for Down Tube (504 Wh)/(418 Wh)

- MTB dedicated design

9 BT-E6001

SHIMANO STEPS Battery for Rear Carrier (504 Wh)

- Capacity: 504Wh (36V, 14Ah)

9 BT-E6000

SHIMANO STEPS Battery for Rear Carrier (418 Wh)

- Capacity: 418Wh (36V, 11.6Ah)

10 SG-C7000

SHIMANO STEPS E-BIKE Dedicated Mechanical Internal Geared Hub Coaster Brake 5-speed

- E-BIKE dedicated IHG

10 SG-C7050

SHIMANO STEPS E-BIKE Dedicated Di2 Internal Geared Hub Disc Brake 5-speed

- Integrated drivetrain and assist



Drive unit, Drive unit cover

E6100 series



SM-DUE61-T
Drive Unit Cover for Trekking

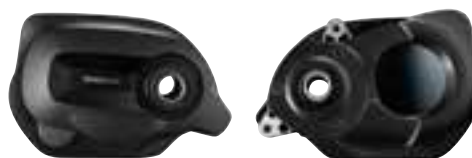

SM-DUE61-C
Drive Unit Cover for City

DU-E6100
Drive Unit for V-BRAKE, Roller Brake, Disc Brake
DU-E6110
Drive Unit for Coaster Brake

E5000 series



SM-DUE50-T
Drive Unit Cover for Trekking



SM-DUE50-C
Drive Unit Cover for City

DU-E5000
Drive Unit for V-BRAKE, Roller Brake,
Disc Brake, Coaster Brake

Drive unit

√=Yes

Model no.		DU-E6100	DU-E6110	DU-E5000
Output characteristics		City/Trekking	City/Trekking	City/Trekking
Maximum rated power (Watt)		250	250	250
Maximum torque (N·m)		60	60	40
Maximum power output (W)		500	500	420
Compatible brake type		V-BRAKE, roller brake, disc brake	Coaster brake	V-BRAKE, roller brake, disc brake, coaster brake
Compatible BB type		24 mm axle serration	24 mm axle serration	Square type
Cable connector		Right side	Right side	Left side
Drive unit chain device		-	-	-
Chain case		√	√	√
Drive unit cover design		E6100 (SM-DUE61-T/C)	E6100 (SM-DUE61-T/C)	E5000 E6100 (SM-DUE50-T/C)
Chain line (mm)		46.5/50/53	46.5/50/53	46.5
Q-factor		180 mm	180 mm	185 mm
 Di2 compatible	INTER-11	√	√	√
	INTER-8	√ Automatic available	√ Automatic available	√ Automatic available
	INTER-7	√	√	√
	INTER-5	√ Automatic available	√ Automatic available	√ Automatic available
	Derailleur type	√	-	√
Maximum support bike speed	25 km/h	√	√	√
	20 mph	√	√	√
	Adjustable (15 km-25 km, 12-20 mph setting by E-TUBE PROJECT)	√	√	√
Assist mode		High, normal, eco	High, normal, eco	High, normal, eco
Walk assist function*	On/off (Set by E-TUBE PROJECT)	√	√	√
	Intelligent	√ (Only in combination with Di2)	√ (Only in combination with Di2)	√ (Only in combination with Di2)
Power supply for front light/rear light		DC 12 V	DC 12 V	DC 12 V
Maximum current supply front and rear light total (A)		2.0	2.0	2.0
Safe way home function		√	√	√
Port for speed sensor (1 pc)		SD50 type	SD50 type	SD50 type
Torque sensor		√	√	√
Crank arm position sensor		√	√	-
Bike speed sensor		SM-DUE10/DUE11	SM-DUE10/DUE11	SM-DUE10/DUE11
Cadence sensor		√	√	-
Weight (kg) w/o cover		2.76	2.7	2.38

Drive unit cover

√=Yes

Model no.		SM-DUE61-T	SM-DUE61-C	SM-DUE50-T	SM-DUE50-C
Cover	Right	√	√	√	√
	Left	√	√	√	√
	Bottom	-	-	-	-
Available DU angle (deg.)		0 - 60	0 - 60	0 - 60	0 - 60
Note		-	-	-	-

* The walk assist mode function may not be able to be used in certain regions. (Singapore, Brazil)

Cycle computer



SC-E6100
Cycle Computer



SC-E5003
Cycle Computer with Assist Switch
(SD300 port)



SC-E5000

√=Yes

Model no.		SC-E6100	SC-E5003	SC-E5000	EW-EN100
Battery management system compatibility	2nd gen.	-	-	-	-
	1st gen.	√	√	√	√
Mount position	Center on handlebar	√	-	-	-
	Right on handlebar	-	-	-	-
	Others	-	*√	*√	√
Wireless system		ANT private Bluetooth®LE	-	-	ANT private Bluetooth®LE
E-TUBE port		SD50 type (3 pcs)	SD300 type (1 pcs)	SD50 type (1 pcs)	SD50 type (2 pcs)
Electric wire removable		-	√	√	√
Back light		√	√	√	-
LCD size (inch)		2.7	1.4	1.4	-
Beep		√	-	-	-
Display detachable		√	-	-	-
Display fixation		-	√	√	-
Display change button		√	√	√	-
Assist mode change (w/o switch unit)		√	√	√	√
Reset button		-	-	-	-
Inside battery		√	-	-	-
System on/off button		√	-	-	-
Light on/off button		√	√	√	√
Assist up/down button		-	√	√	-
Auto start & auto stop		-	-	-	-
Contents of display	Clock	√	-	-	-
	Assist mode display	√	√	√	√
	Assist on/off	√	-	-	-
	Walk mode display*	√	√	√	√
	Battery charge level	√	√	√	√
	Light condition	√	-	-	-
	Current speed	√	√	√	-
	Gear position display	√	√	√	-
	Start mode	√	-	-	-
	Automatic shift mode	√	√	√	-
	Maximum speed	**√	-	-	-
	Average speed	**√	-	-	-
	Trip distance	√	√	√	-
	Trip time	**√	-	-	-
Odometer	√	√	√	-	

* The walk assist mode function may not be able to be used in certain regions. (Singapore, Brazil)



SC-E5000
Cycle Computer with Assist Switch

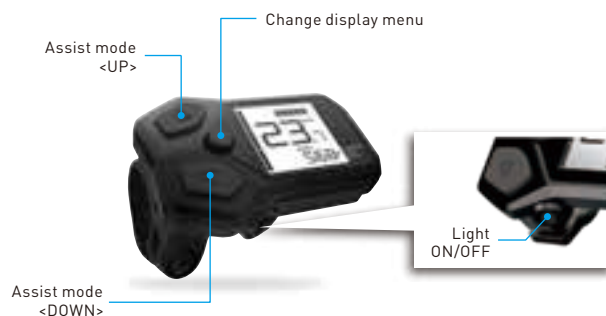

SC-E5000



EW-EN100
Junction A for E-bike



v=Yes

Model no.		SC-E6100	SC-E5003	SC-E5000	EW-EN100
Contents of display	Estimated range	√	√	√	-
	Range overview	√	-	-	-
	Assist power indicator	√	-	-	-
	Error message	√	√	√	√
	Cadence (rpm)	**√	-	-	-
	Shifting advice	√	-	-	-
	Maintenance alert	√	***√	***√	-
	Bluetooth®LE connection status	√	-	-	-
Setting menu	Trip distance reset	√	√	√	-
	Odometer reset	-	-	-	-
	Setting clear	√	-	-	-
	Clock adjustment	√	-	-	-
	Start mode	√	***-	***-	-
	Shifting advise	√	-	-	-
	Back light on/off	√	***-	***-	-
	Light on/off	-	***-	***-	-
	Back light brightness	√	-	-	-
	Beep on/off	√	-	-	-
	Unit (km/mile)	√	**√	**√	-
	Font color	√	-	-	-
	Adjusting for shift	*√	***-	***-	*√
	Adjusting for auto shift timing	*√	***-	***-	-
	RD protection reset	*√	-	-	*√
	Bluetooth®LE pairing	√	-	-	√
	Bluetooth®LE/ANT connection status	-	-	-	-
Assist customize	-	-	-	-	
Language	English/german/dutch/ french/spanish/italian	English	English	-	
Note	* In case of SEIS ** Option by E-TUBE PROJECT	* Left on handlebar (normal specification and I-SPEC EV specification) ** Setting by E-TUBE PROJECT *** Drive unit setting by E-TUBE PROJECT	* Left on handlebar (normal specification and I-SPEC EV specification) ** Setting by E-TUBE PROJECT *** Drive unit setting by E-TUBE PROJECT	* Set by switch operation in case of SEIS	

Switch unit, Crank arm, Chainring



SW-E7000-L
Left Switch Unit for Assist

SW-E7000-R
Right Switch Unit for SEIS Shift



SW-E6010-L
Left Switch Unit for Assist

SW-E6010-R
Right Switch Unit for SEIS Shift



FC-E6100
E-bike Crankset



FC-E5000
E-bike Crankset



FC-E5010
E-bike Crankset



SM-CRE61
Chainring (38T)



SM-CRE61
Chainring (38T)



SM-CRE61
Chainring (38T)



SM-CRE50
Chainring (38T)



SM-CRE50
Chainring (38T)



SM-CRE50
Chainring (38T)

Switch unit

√=Yes

Model no.		SW-E7000-L	SW-E7000-R	SW-E6010-L	SW-E6010-R
Usage		For assist	For SEIS shift	For assist	For SEIS shift
Electric wire removable		-	-	-	-
Firmware update by E-TUBE PROJECT		√	√	√	√
Electric wire port	SD50 type (pc)	0	0	0	0
	SD300 type (pc)	0	0	0	0
Electric wire connector	SD50 type (pc)	1	1	1	1
	SD300 type (pc)	0	0	0	0
Assist mode change		√	-	√	-
Display change		-	-	√	√
Automatic/manual change		-	√	√	√
Light on-off		-	-	*_	-
Multiple input	2 step	-	-	-	-
	Hold	√	√	-	**√
Average weight		23.9 g	23.9 g	31.3 g	31.3 g
Note				* By setting menu	** Available for rear derailleur

Crank arm

√=Yes

Brand		SHIMANO	SHIMANO	SHIMANO
Model no.		FC-E6100	FC-E5000	FC-E5010
Crank arm type		-	-	-
	Solid	√	√	√
Q factor (mm)		180	185	185
BB type		24 mm axle serration	Square type	Square type
Crank arm length (mm)	160 mm	-	-	-
	165 mm	-	√	√
	170 mm	√	√	√
	175 mm	√	√	√
Color		Silver/Black	Silver	Standard
Note		-	-	-

Chainring

√=Yes

Speed		9/10/11-speed	
Model no.		SM-CRE61	SM-CRE50
Chain line (mm)	53	-	-
	50	-	-
	46.5	√	√
Chainring teeth	34T	-	-
	36T	-	-
	38T	√	√
	42T	-	-
	44T	√	√
	47T	-	-
		-	-
Chainring material		Steel	Steel
Chain guard type	Double	√	√
	Single	√	√
	w/o CG	√	√
Chain device compatible		-	-
Chain case compatible		√	√
Note			-

Internal geared hub spec



SG-C7002-5CD
E-bike Dedicated Internal Geared Hub
Coaster and Disc Brake 5-speed



SG-C7000-5C
E-bike Dedicated Mechanical Internal
Geared Hub Coaster Brake 5-speed



SG-C7050-5D
E-bike Dedicated Di2 Internal Geared Hub
Disc Brake 5-speed

Internal geared hub spec

V=Yes

Series		SHIMANO Nexus						
Model no.		SG-C7002-5CD	SG-C7000-5V	SG-C7000-5R	SG-C7000-5C	SG-C7000-5D	SG-C7050-5V	SG-C7050-5D
Function name		INTER-5E	INTER-5E	INTER-5E	INTER-5E	INTER-5E	INTER-5E	INTER-5E
Color	1	Silver	Silver	Silver	Silver	Silver	Silver	Silver
	2	Black	Black	Black	Black	Black	Black	Black
	3	-	-	-	-	-	-	-
Brake type	Mount type	Coaster brake, special disc brake mount for SM-RTC60	V-BRAKE	INTER-M	Coaster brake	CENTER LOCK disc brake	V-BRAKE	CENTER LOCK disc brake
	Recommended model	BR-M6100 BR-MT420	-	BR-C6000 BR-C3010 BR-C3000	-	-	-	-
Speeds		5	5	5	5	5	5	5
Gear ratio	Total	263%	263%	263%	263%	263%	263%	263%
	1	1	1	1	1	1	1	1
	2	1.277	1.277	1.277	1.277	1.277	1.277	1.277
	3	1.622	1.622	1.622	1.622	1.622	1.622	1.622
	4	2.07	2.07	2.07	2.07	2.07	2.07	2.07
	5	2.63	2.63	2.63	2.63	2.63	2.63	2.63
	6	-	-	-	-	-	-	-
	7	-	-	-	-	-	-	-
	8	-	-	-	-	-	-	-
	9	-	-	-	-	-	-	-
	10	-	-	-	-	-	-	-
Shifting structure		Top normal	Top normal	Top normal	Top normal	Top normal	Di2	Di2
Silent clutch		√	√	√	√	√	√	√
Gear change support mechanism		√	√	√	√	√	√	√
Shifting POWER MODULATOR		√	√	√	√	√	√	√
Driving efficiency		High	High	High	High	High	High	High
w/ left hand dust cap		-	√	-	-	-	√	-
O.L.D. (mm)		135	135	135	135	135	135	135
Spoke size		#13/#14	#13/#14	#13/#14	#13/#14	#13/#14	#13/#14	#13/#14
Spoke hole	28H	-	-	-	-	-	-	-
	32H	√	√	√	√	√	-	√
	36H	√	√	√	√	√	√	√
	Others	-	-	-	-	-	-	-
Axle length (mm)	182	-	-	-	-	-	-	-
	184	-	-	-	-	-	-	-
	187	√	√	√	√	√	√	√
	193	-	-	-	-	-	-	-
	Others	-	-	-	-	-	-	-
Flange distance (mm)		58.3	58.3	58.3	58.3	57.3	58.3	57.3
Flange diameter (mm)		105.2	105.2	105.2	105.2	105.2	105.2	105.2
Flange width (mm)	Right	3.2	3.2	3.2	3.2	3.2	3.2	3.2
	Left	3.2	3.2	3.2	3.2	3.2	3.2	3.2
Offset (mm)		3.7	3.2	3.2	3.7	3.2	3.7	3.2
P.C.D left/right. (mm)		92.6	92.6	92.6	92.6	92.6	92.6	92.6
Average weight		2,010 g	1,670 g	1,670 g	1,970 g	1,650 g	1,670 g	1,670 g
Note			-	-	-	-		

Shifter, Motor unit, Cassette



SL-C7000-5
REVOSHIFT Shifter for INTER-5E Hub



MU-UR510
Motor Unit



MU-UR500
Motor Unit



CS-C7000
Single Sprocket for E-bike (27T)

Shifter

√=Yes

Model no.		SL-C7000-5
Color	1	Silver
	2	Black
	3	-
Shifter type		REVOSHIFT
Top-Normal		√
Front speeds		-
Rear speeds		5
Compatible rear derailleur/internal geared hub type		NEXUS INTER-5E
Compatible front derailleur type		-
Shifter position adjust		-
Shifter cable adjust		√
Max. multiple shifts (Main lever/rear)		4
Release function	MULTI RELEASE	-
	INSTANT RELEASE	-
	2-WAY RELEASE	-
OPTICAL GEAR DISPLAY	with	Window
	with (removable)	-
	without	-
Multi-Bearing construction		-
Shifter cable	Material	Stainless steel
	Finish	-
Recommended shifter outer casing		OT-SP41
Clamping diameter (mm)		22.2
Average weight		-
Note		w/ rubber bellows spec. is available

Motor unit

√=Yes

Model no.		MU-UR510	MU-UR500
Color	1	Black	Standard
	2	-	-
	3	-	-
Compatible internal geared hub		SG-S7051 SG-C7050	SG-S705 SG-S7051 SG-C6060 SG-C7050
Compatible speed		11/8/5-speed	11/8/5-speed
Master unit		-	-
Firmware update by E-TUBE PROJECT		√	√
SD50 port (pcs)		0	1
SD300 port (pcs)		1	0
SD50 connector (pcs)		0	0
SD300 connector (pcs)		0	0
Note		-	-

Cassette

√=Yes

Model no.		CS-C7000
Chain guard	with	-
	without	√
Gear teeth	14T	-
	16T	-
	18T	-
	19T	-
	20T	-
	21T	-
	22T	-
	23T	-
	24T	√
	27T	√
30T	√	
Gear thickness (mm)		2.3
Recommended chain	Super narrow HG 9-speed	-
	HG 8-speed (1/2 inch x 3/32 inch)	√
	1/2 inch x 1/8 inch	-
Note		

E-Cargo

LOADS OF FUN

E-Cargo bikes make it easier than ever for busy people to transport their kids, pets, and other precious items day after day. Make the move to car-light or car-free with a delightfully refined pedal assist that gives you a helping hand without trading the cycling experience you love. If you are looking for a way to transform school runs, shopping trips, and the daily haul — look for the yellow cargo sticker.





Technical Specifications



1 DU-EP600-CRG

EP6 Drive Unit for Cargo bike use

- Cargo-dedicated version of our powerful and efficient DU-EP600 drive unit

1 DU-EP801-CRG

EP8 Drive Unit for Cargo bike use

- Cargo-dedicated version of our powerful and efficient DU-EP801 drive unit

2 DC-EP801-A

EP8 Drive Unit Cover (Mount Bolt Exposed Type)

- Compact cover

2 DC-EP801-B

EP8 Drive Unit Cover (Mount Bolt Covered Type)

- Large cover

2 DC-EP801-G

EP8 Drive Unit Guard

- Guard cover for drive unit bottom



EP600-CRG



EP801-CRG

3 SW-EN600**SHIMANO STEPS Left Switch Unit for Assist/SHIMANO STEPS Di2 Right Switch Unit for Shifting**

- Simple and intuitive button operation

3 SW-EM800-L**EP8 Left Switch Unit for Assist**

- Improved ergonomics

4 SC-EN600/SC-EN610**SHIMANO STEPS Cycle Computer**

- Customizable data dashboards let you select four riding metrics per screen with the E-TUBE PROJECT APP

4 SC-EN500**SHIMANO STEPS Cycle Computer with Assist Switch (SD300 port)**

- Integrated single unit for more attractive and affordable City/Trekking e-bikes

**5 EW-SD300****Electric Wire SD300 for External Routing**

- More compact design makes new electric components smaller and lighter

6 EW-SW310**SHIMANO STEPS Satellite System On/Off Switch (SD300)**

- Pair with SW-EM800 and EW-SW310 for a simple e-MTB cockpit

6 EW-CA110**CAN Cable with Connector**

- Compatible with DU-EP801/EP600

7 BT-EN606**SHIMANO STEPS Battery for Down Tube (630 Wh)**

- Capacity: 630 Wh (36 V, 17.5 Ah)

7 BT-EN605**SHIMANO STEPS Battery for Down Tube (504 Wh)**

- Capacity: 504 Wh (36 V, 14 Ah)

7 BT-EN604**SHIMANO STEPS Battery for Down Tube (418 Wh)**

- Capacity: 418 Wh (36 V, 11.6 Ah)

7 BT-EN405**SHIMANO STEPS Battery for Rear Carrier (504 Wh)**

- Capacity: 504 Wh (36 V, 14 Ah)

7 BT-EN404**SHIMANO STEPS Battery for Rear Carrier (418 Wh)**

- Capacity: 418 Wh (36 V, 11.6 Ah)



Technical Specifications



1 DU-E6100-CRG

Drive Unit for Cargo Bike Use

- Dedicated cargo assist firmware

1 DU-EP800-CRG

Drive Unit for Cargo Bike Use

- Cargo-dedicated version of our powerful and efficient EP-800 drive unit

2 DC-EP800-A/B

EP8 Drive Unit Cover (Mount Bolt Exposed Type)/(Mount Bolt Covered Type)

- Aggressive MTB riding design

2 DC-EP800-G

EP8 Drive Unit Guard

- Aggressive MTB riding design

2 SM-DUE61-TCRG/CCRG

SHIMANO STEPS E6100 Drive Unit Cover for Cargo Bike Use



E6100-CRG
TREKKING



EP800-CRG



E6100-CRG
CITY

3 SW-E6010-L/R

SHIMANO STEPS E6000 Left Switch Unit for Assist/Right Switch Unit for SEIS Shift

- Attractive styling

3 SW-EM800-L

EP8 Left Switch Unit for Assist

- Improved ergonomics

4 SC-E6100

SHIMANO STEPS E6100 Cycle Computer

- Assist mode

4 SC-EM800

EP8 Cycle Computer

- Compact and low-profile MTB design

**5 EW-SD50**

E-TUBE Electric Wire

- Transmits interactive signals and power supply to each electronic components by "plug & gap" connection

**5 EW-SD300**

Electric Wire SD300 for External Routing

- More compact design makes new electric components smaller and lighter

6 EW-SW100

SHIMANO STEPS Satellite System On/Off Switch for E-BIKE

- Compact, semi-integrated frame charging port

6 EW-SW300

SHIMANO STEPS SD300 Satellite System On/Off Switch

- Compact, semi-integrated frame satellite switch

7 BT-E8016

SHIMANO STEPS Battery for Down Tube (630 Wh)

- Compact and low-center of gravity

Drive unit, Drive unit cover, Drive unit guard

EP8

EP801 series



DU-EP801-CRG

DU-EP801-CRG

EP8 Drive Unit for Cargo bike use

- Cargo-dedicated version of our powerful and efficient DU-EP801 drive unit
- Specially tuned cargo assist firmware
 - » Retains all of DU-EP801's great functions and features



DC-EP801-A
Drive Unit Cover
(Mount Bolt Exposed Type)



DC-EP801-B
Drive Unit Cover
(Mount Bolt Covered Type)



DC-EP801-G
Drive Unit Guard

EP6

EP600 series



DU-EP600-CRG

DU-EP600-CRG

EP6 Drive Unit for Cargo bike use

- Cargo-dedicated version of our powerful and efficient DU-EP600 drive unit
- Specially tuned cargo assist firmware
 - » Retains all of DU-EP600's great functions and features

Drive unit

√=Yes

Model no.		DU-EP801-CRG	DU-EP600-CRG
Output characteristics		CARGO	CARGO
Continuous rated power (Watt)		250	250
Maximum torque (N·m)		85	85
Compatible brake type		Disc brake	Disc brake
Chain case		√	√
Drive unit cover design		DU-EP801-A/B	DU-EP801-A/B
Maximum support bike speed	25 km/h	√	√
	20 mph	√	√
	28 mph	√ US Class3 (comply with California) only	√ US Class3 (comply with California) only
	Adjustment	-	-
Assist mode		Boost, trail, eco High, normal, eco	Boost, trail, eco High, normal, eco
Walk assist function*	On/off (Set by E-TUBE PROJECT)	√	√
	Intelligent	√ (In case of Di2)	√ (In case of Di2)
	Quick	√	√
Power supply for front light/rear light		DC 12 V	DC 12 V
Maximum current supply front and rear light total (A)		2.0	2.0
Power supply and maximum current for ACC		12 V DC/2.0 A	12 V DC/2.0 A
Power supply and maximum current for CAN port		12 V DC/2.0 A	12 V DC/2.0 A
Safe way home function		√	√
Port for speed sensor (1 pc)		SD300 type	SD300 type
Torque sensor		√	√
Crank arm position sensor		√	√
Bike speed sensor		EW-SS300/SS301/SS302	EW-SS300/SS301/SS302
Cadence sensor		√	√
Weight (kg) w/o cover		2.7	3.0

Drive unit cover, Drive unit guard

√=Yes

Model no.		DC-EP801-A	DC-EP801-B	DC-EP801-G
Cover	Right	-	-	-
	Left	√	√	-
	Bottom	-	-	√
Available DU angle (deg.)		0 - 60	0 - 60	0 - 60
Note		-	-	-

* The walk assist mode function may not be able to be used in certain regions. (Singapore, Brazil)

Drive unit, Drive unit cover, Drive unit guard

EP8

EP800 series



DU-EP800-CRG

DU-EP800-CRG

Drive Unit for Cargo Bike Use

- Cargo-dedicated version of our powerful and efficient EP-800 drive unit
- Dedicated cargo assist firmware
- Retains all of DU-EP800's great functions and features
 - » Quiet, lightweight, compact & integrated design
 - » Strong heat-resistance on long climbs
 - » Smooth pedaling
 - » Max. output 85 N·m
 - » Walk assist mode
 - » Start mode available when used with a Di2 internal geared hub
 - » Full-automatic shifting available when used with a Di2 internal geared hub
- Weight: 2,600 g



DC-EP800-A
Drive Unit Cover
(Exposed Mounting
Screw Type)



DC-EP800-B
Drive Unit Cover
(Covered Mounting
Screw Type)



DC-EP800-G
Drive Unit Guard



E6100 series



DU-E6100-CRG

DU-E6100-CRG

Drive Unit for Cargo Bike Use

- Dedicated cargo assist firmware
- Optimized pedaling efficiency
 - » Compact & integrated design
 - » Smooth pedaling
 - » Max. output 60 N·m
 - » Walk assist mode
 - » Start mode available when used with a Di2 internal geared hub
 - » Full-automatic shifting available when used with a Di2 internal geared hub
- Weight: 2,760 g



SM-DUE61-TCRG
Drive Unit Cover for Cargo Bike



SM-DUE61-CCRG
Drive Unit Cover for Cargo Bike

Drive unit

√=Yes

Model no.		DU-EP800-CRG	DU-E6100-CRG
Output characteristics		CARGO	CARGO
Maximum rated power (Watt)		250	250
Maximum torque (N-m)		85	60
Maximum power output (W)		500	500
Compatible brake type		Disc brake	Disc brake
Compatible BB type		24 mm axle serration	24 mm axle serration
Cable connector		Left side	Right side
Drive unit chain device		CD-EM800 SM-CDE80/70	-
Chain case		-	√
Drive unit cover design		DU-EP800-A/B	E6100 (SM-DUE61-TCRG/CCRG)
Chain line (mm)		50/53/56.5	46.5/50/53
Q-factor		177 mm	180 mm
 Di2 compatible	INTER-11	√	√
	INTER-8	√ Automatic available	√ Automatic available
	INTER-7	-	√
	INTER-5E	√ Automatic available	√ Automatic available
	Derailleur type	√	√
Maximum support bike speed	25 km/h	√	√
	20 mph	√	√
	Adjustable (15 km-25 km, 12-20 mph setting by E-TUBE PROJECT)	-	√
Assist mode		Boost, trail, eco	High, normal, eco
Walk assist function*	On/off (Set by E-TUBE PROJECT)	√	√
	Intelligent	√ (In case of Di2)	√ (In case of Di2)
Power supply for front light/rear light		DC 12 V	DC 12 V
Maximum current supply front and rear light total (A)		2.0	2.0
Safe way home function		√	√
Port for speed sensor (1 pc)		SD300 type	SD50 type
Torque sensor		√	√
Crank arm position sensor		√	√
Bike speed sensor		EW-SS300/SS301	SM-DUE10/DUE11
Cadence sensor		√	√
Weight (kg) w/o cover		2.6	2.76

Drive unit cover, Drive unit guard

√=Yes

Model no.		DC-EP800-A	DC-EP800-B	DC-EP800-G	SM-DUE61-TCRG	SM-DUE61-CCRG
Cover	Right	-	-	-	√	√
	Left	√	√	-	√	√
	Bottom	-	-	√	-	-
Available DU angle (deg.)		0 - 60	0 - 60	0 - 60	0 - 60	0 - 60
Note		-	-	-	CARGO logo for DU-E6100-CRG	CARGO logo for DU-E6100-CRG

* The walk assist mode bike may not be able to be used in certain regions. (Singapore, Brazil)

LINKGLIDE 11/10/9-speed drivetrain



RD-M8150-11



RD-M8150-11

SHIMANO DEORE XT Di2 Rear Derailleur 1x11-speed

- AUTO SHIFT WITH MANUAL OVERRIDE uses an advanced shifting algorithm to continually analyze data from multiple sensors to automatically put you in the optimal gear without requiring manual input at the shifter
- FREE SHIFT allows you to select the optimal gear while coasting into switchbacks or dynamic terrain changes, so you're always ready to charge with better balance and control
- Durable drive quality and enduring shifting performance
 - LINKGLIDE
- Quick and smooth shifting under the heavier torque loads of e-bikes
- Power directly supplied from main STEPS battery
- Customize and run diagnostics with E-TUBE PROJECT
- Low-profile design offers uninterrupted rear shifting on rough terrain
 - SHIMANO SHADOW RD+
 - » Connect directly to STEPS via E-TUBE cable EW-SD300
 - » Wide range: 11-50T

V=Yes

Brand		SHIMANO DEORE XT
Model no.		RD-M8150-11
Color		Series color
Rear speeds		11-speed
Compatible chain		HG-X11 11-speed CN-LG500
Top-normal spring type		SHIMANO SHADOW RD+
Mount		Direct attachment (conventional)
Mode converter		-
Cable adjuster		-
Max. front difference		0T
Total capacity		39T
Low sprocket	Max.	50T
	Min.	50T
Top sprocket	Max.	11T
	Min.	11T
Fluoric coated link bushings		3
Pulley	Guide pulley bearing	Sealed Bearing
	Tension pulley bearing	Sealed Bearing
	Teeth	13T
	Screws material	Stainless steel
	Sunken type pulley screw	√
Bracket	Material	Aluminum
	Finish	Anodized
B-axle	Hollow axle	√
	Material	Aluminum
	Finish	Anodized
B-axle 2	Hollow axle	√
	Material	Aluminum
	Finish	Anodized
Bracket body	Material	Aluminum
	Finish	Painted

Brand		SHIMANO DEORE XT
Model no.		RD-M8150-11
P-axle	Material	Steel
	Finish	-
Plate body	Material	GFRP
	Finish	-
Outer link	Material	Aluminum
	Finish	Painted
Inner link	Material	Aluminum
	Finish	Anodized
Outer plate	Material	Aluminum
	Finish	Painted
Inner plate	Material	Aluminum
	Finish	Painted
Cable fixing screw	Material	-
	Finish	-
Stroke adjusting screw	Material	-
	Finish	-
Di2 connectivity wired	Di2 shifting	√
Di2 connectivity wireless	Di2 shifting	-
SD50 port (pcs)		0
SD300 port (pcs)		1
SD50 connector (pcs)		0
SD300 connector (pcs)		0
LED for system status		-
Charging port		-
Charging cable		-
Note		

√=Yes

SHIMANO
DEORE XT

RD-M8130-SGS



RD-M8130-SGS

SHIMANO SHADOW RD+ (1x11-speed)

- Smooth & decisive shift performance
 - » Smoother shifting
 - System designed to integrate with LINKGLIDE cassettes
 - » Rear derailleur stabilizer reduces chain slap and improves chain stability
 - » Low-profile design is optimized for rough terrain
- Total capacity: 39T

SHIMANO
DEORE

RD-M5130-GS



RD-M5130-GS

SHIMANO SHADOW RD+ (1x10-speed)

- Smooth & decisive shift performance
 - » Smoother shifting
 - System designed to integrate with LINKGLIDE cassettes
 - » Rear derailleur stabilizer reduces chain slap and improves chain stability
 - » Low-profile design is optimized for rough terrain
- Total capacity: 32T

Brand		SHIMANO DEORE XT	SHIMANO DEORE
Model no.		RD-M8130-SGS	RD-M5130-GS
Color		Series color	Series color
Rear speeds		11-speed	10-speed
Compatible chain		HG-X11 11-speed CN-LG500	HG-X11 11-speed CN-LG500
Top-normal spring type		SHIMANO SHADOW RD+	SHIMANO SHADOW RD+
Mount		Direct attachment [conventional]	Direct attachment [conventional]
Mode converter		-	-
Cable adjuster		-	-
Max. front difference		0T	0T
Total capacity		39T	32T
Low sprocket	Max.	50T	43T
	Min.	50T	43T
Top sprocket	Max.	11T	11T
	Min.	11T	11T
Fluoric coated link bushings		7	7
Pulley	Guide pulley bearing	Sealed Bearing	Bush
	Tension pulley bearing	Sealed Bearing	Bush
	Teeth	13T	13T
	Screws material	Stainless steel	Stainless steel
	Sunken type pulley screw	√	√
B-axle	Hollow axle	√	-
	Material	Stainless steel	Stainless steel
	Finish	-	-
B-axle 2	Hollow axle	-	-
	Material	-	-
Bracket body	Material	Aluminum	Aluminum
	Finish	Painted	Painted
P-axle	Material	Steel	Steel
	Finish	-	-
Plate body	Material	GFRP	GFRP
	Finish	-	-
Outer link	Material	Aluminum	Aluminum
	Finish	Painted	Painted
Inner link	Material	Aluminum	Aluminum
	Finish	Painted	Painted
Outer plate	Material	Aluminum	Steel
	Finish	Painted	Painted
Inner plate	Material	Aluminum	Steel
	Finish	Painted	Painted
Cable fixing screw	Material	Stainless steel	Stainless steel
	Finish	-	-
Stroke adjusting screw	Material	Steel	Steel
	Finish	Plated	Plated
Average weight (g)		308	-
Note		w/Bumper on pully cage	-

LINKGLIDE 11/10/9-speed drivetrain

v=Yes

SHIMANO
CUES



RD-U6070



Di2
DIGITAL INTEGRATED INTELLIGENCE

LINKGLIDE

RD-U6070

SHIMANO CUES Di2 LINKGLIDE Rear Derailleur 1x11-speed

- Automatic shifting compatibility lets anyone enjoy fun and sporty action without being an expert
» Compatible with LINKGLIDE 11-50T 11-speed CS
- Always be ready for action in the right gear with SHIMANO STEPS enabled FREE SHIFT
- Automatic shifting without pedaling

SHIMANO
CUES



RD-U6050



Di2
DIGITAL INTEGRATED INTELLIGENCE

LINKGLIDE

RD-U6050

SHIMANO CUES Di2 LINKGLIDE Rear Derailleur 1x10-speed

- Automatic shifting compatibility lets anyone enjoy fun and sporty action without being an expert
» Compatible with LINKGLIDE 11-43T 10-speed CS
- Always be ready for action in the right gear with SHIMANO STEPS enabled FREE SHIFT
- Automatic shifting without pedaling

Brand		SHIMANO CUES	SHIMANO CUES
Model no.		RD-U6070	RD-U6050
Color		Series color	Series color
Rear speeds		11-speed	10-speed
Top-normal spring type		SHIMANO SHADOW RD	SHIMANO SHADOW RD
Mount		Direct attachment (conventional)	Direct attachment (conventional)
Max. front difference		Single	Single
Total capacity		39T	32T
Low sprocket	Max.	50T	43T
	Min.	50T	43T
Top sprocket	Max.	11T	11T
	Min.	11T	11T
Fluoric coated link bushings		2	2
Pulley	Guide pulley bearing	-	-
	Tension pulley bearing	-	-
	Teeth	11T	11T
	Screws material	Stainless steel	Stainless steel
Bracket	Sunken type pulley screw	√	√
	Material	Steel	Steel
B-axle	Finish	Painted	Painted
	Hollow axle	√	√
B-axle 2	Material	Stainless steel	Stainless steel
	Finish	Painted	Painted
Bracket body	Hollow axle	-	-
	Material	Stainless steel	Stainless steel
P-axle	Finish	Painted	Painted
	Material	Aluminum	Aluminum
Plate body	Finish	Painted	Painted
	Material	Steel	Steel
Outer link	Finish	Plating	Plating
	Material	PA+GF	PA+GF
Inner link	Finish	-	-
	Material	PA+GF	PA+GF
Outer plate	Finish	Painted	Painted
	Material	Steel	Steel
Inner plate	Finish	Painted	Painted
	Material	Steel	Steel
Stroke adjusting screw	Finish	Plating	Plating
	Material	Steel	Steel
Di2 connectivity wired	Di2 shifting	√	√
Firmware update by E-TUBE PROJECT		√	√
SD50 port (pcs)		-	-
SD300 port (pcs)		1	1
SD50 connector (pcs)		-	-
SD300 connector (pcs)		-	-
LED for system status		√	√
Charging port		-	-
Charging cable		-	-
Note			

SHIMANO
CUES



RD-U8000



LINKGLIDE

RD-U8000 **NEW**

SHIMANO CUES SHADOW RD+ Rear Derailleur 11-speed

- Seamless shifting and pedaling performance that's made to last
 - » Chain stabilizer reduces chain drop, slap and noise
 - » Low-profile design protects rear derailleur from obstacles in a wide variety of riding scenes
 - » Stylish and polished aluminum finish with machine-cut textures
 - » Total capacity: 39T

SHIMANO
CUES



RD-U8020



LINKGLIDE

RD-U8020 **NEW**

SHIMANO CUES SHADOW RD+ Rear Derailleur 11-speed

- Seamless shifting and pedaling performance that's made to last
 - » Chain stabilizer reduces chain drop, slap and noise
 - » Low-profile design is optimized for rough terrain
 - » Stylish, polished and machine-cut aluminum textures
 - » Total capacity: 48T

		NEW	NEW	v=Yes
Brand		SHIMANO CUES	SHIMANO CUES	
Model no.		RD-U8000	RD-U8020	
Color		Series color	Series color	
Rear speeds		11-speed	11-speed	
Compatible chain		LINKGLIDE, HG 11-speed	LINKGLIDE, HG 11-speed	
Top-normal spring type		SHIMANO SHADOW RD+	SHIMANO SHADOW RD+	
Mount		Direct attachment (conventional)	Direct attachment (conventional)	
Mode converter		-	-	
Cable adjuster		√	√	
Max. front difference		0T	14T	
Total capacity		39T	48T	
Low sprocket	Max.	50T	45T	
	Min.	50T	45T	
Top sprocket	Max.	11T	11T	
	Min.	11T	11T	
Fluoric coated link bushings		4	4	
Pulley	Guide pulley bearing	Sealed Bearing	Sealed Bearing	
	Tension pulley bearing	Sealed Bearing	Sealed Bearing	
	Teeth	13/13T	11/13T	
	Screws material	Steel	Steel	
	Sunken type pulley screw	√	√	
Bracket	Material	-	-	
	Finish	-	-	
B-axle	Hollow axle	-	-	
	Material	Aluminum	Aluminum	
	Finish	Black	Black	
B-axle 2	Hollow axle	-	-	
	Material	-	-	
	Finish	-	-	
Bracket body	Material	Aluminum	Aluminum	
	Finish	Painted	Painted	
P-axle	Material	Steel	Steel	
	Finish	-	-	
Plate body	Material	PA+GF	PA+GF	
	Finish	-	-	
Outer link	Material	Aluminum	Aluminum	
	Finish	Painted	Painted	
Inner link	Material	Aluminum	Aluminum	
	Finish	Painted	Painted	
Outer plate	Material	Aluminum	Aluminum	
	Finish	Painted	Painted	
Inner plate	Material	Aluminum	Aluminum	
	Finish	Painted	Painted	
Cable fixing screw	Material	Stainless steel	Stainless steel	
	Finish	Black	Black	
Stroke adjusting screw	Material	Steel	Steel	
	Finish	Plated	Plated	
Average weight (g)		-	-	
Note		E-bike rated	E-bike rated	

LINKGLIDE 11/10/9-speed drivetrain

SHIMANO
CUES



RD-U6000



RD-U6000 NEW

SHIMANO CUES SHADOW RD+ Rear Derailleur 10/11-speed

- Stable drivetrain performance on trails, gravel, and city streets
 - » Chain stabilizer reduces chain drop, slap and noise
 - » Low-profile design is optimized for rough terrain
 - » Total capacity: 39T
 - » Max low sprocket: 50T (1x11-speed), 48T (1x10-speed)
- Designed and tested to provide enduring e-biking performance
 - E-BIKE RATED

SHIMANO
CUES



RD-U6020-11



RD-U6020-11 NEW

SHIMANO CUES SHADOW RD Rear Derailleur 11-speed

- Stable drivetrain performance on trails, gravel, and city streets
 - » Low-profile design protects rear derailleur from obstacles in a wide variety of riding scenes
 - » Total capacity: 48T
 - » Max low sprocket: 45T (2x11-speed)
- Designed and tested to provide enduring e-biking performance
 - E-BIKE RATED

		NEW	NEW	v=Yes
Brand		SHIMANO CUES	SHIMANO CUES	
Model no.		RD-U6000	RD-U6020-11	
Color		Series color	Series color	
Rear speeds		11/10-speed	11-speed	
Compatible chain		LINKGLIDE, HG 11-speed	LINKGLIDE, HG 11-speed	
Top-normal spring type		SHIMANO SHADOW RD+	SHIMANO SHADOW RD	
Mount		Direct attachment (conventional)	Direct attachment (conventional)	
Mode converter		-	-	
Cable adjuster		√	√	
Max. front difference		0T	14T	
Total capacity		39T	48T	
Low sprocket	Max.	50T	45T	
	Min.	48T	45T	
Top sprocket	Max.	11T	11T	
	Min.	11T	11T	
Fluoric coated link bushings		3	3	
Pulley	Guide pulley bearing	-	-	
	Tension pulley bearing	-	-	
	Teeth	13/13T	11/13T	
	Screws material	Steel	Steel	
	Sunken type pulley screw	√	√	
Bracket	Material	-	-	
	Finish	-	-	
B-axle	Hollow axle	-	-	
	Material	Stainless steel	Stainless steel	
	Finish	-	-	
B-axle 2	Hollow axle	-	-	
	Material	-	-	
	Finish	-	-	
Bracket body	Material	Aluminum	Aluminum	
	Finish	Painted	Painted	
P-axle	Material	Steel	Steel	
	Finish	-	-	
Plate body	Material	PA+GF	PA+GF	
	Finish	-	-	
Outer link	Material	Aluminum	PA+GF	
	Finish	Painted	Painted	
Inner link	Material	Aluminum	PA+GF	
	Finish	Painted	-	
Outer plate	Material	Steel	Steel	
	Finish	Painted	Painted	
Inner plate	Material	Steel	Steel	
	Finish	Painted	Painted	
Cable fixing screw	Material	Stainless steel	Stainless steel	
	Finish	-	-	
Stroke adjusting screw	Material	Steel	Steel	
	Finish	Plated	Plated	
Average weight [g]		-	-	
Note		E-bike rated	E-bike rated	

SHIMANO
CUES



RD-U6020-10



RD-U6020-10 **NEW**

SHIMANO CUES SHADOW RD Rear Derailleur 10-speed

- Stable drivetrain performance on trails, gravel, and city streets
 - » Low-profile design protects rear derailleur from obstacles in a wide variety of riding scenes
 - » Total capacity: 44T
 - » Max low sprocket: 39T (2x10-speed)
- Designed and tested to provide enduring e-biking performance
 - E-BIKE RATED

SHIMANO
CUES



RD-U4000



RD-U4000 **NEW**

SHIMANO CUES SHADOW RD Rear Derailleur 9-speed

- Stable drivetrain performance on trails, gravel, and city streets
 - » Optimized geometry and spring tension reduce chain drop
 - » Low-profile design is optimized for rough terrain
 - » Total capacity: 35T
 - » Max low sprocket: 46T
 - » Min low sprocket: 41T
- Designed and tested to provide enduring e-biking performance
 - E-BIKE RATED

		NEW	NEW	v=Yes
Brand		SHIMANO CUES	SHIMANO CUES	
Model no.		RD-U6020-10	RD-U4000	
Color		Series color	Series color	
Rear speeds		10-speed	9-speed	
Compatible chain		LINKGLIDE, HG 11-speed	LINKGLIDE, HG 11-speed	
Top-normal spring type		SHIMANO SHADOW RD	SHIMANO SHADOW RD	
Mount		Direct attachment (conventional)	Direct attachment (conventional)	
Mode converter		-	-	
Cable adjuster		√	√	
Max. front difference		16T	0T	
Total capacity		44T	35T	
Low sprocket	Max.	39T	46T	
	Min.	39T	41T	
Top sprocket	Max.	11T	11T	
	Min.	11T	11T	
Fluoric coated link bushings		3	1	
Pulley	Guide pulley bearing	-	-	
	Tension pulley bearing	-	-	
	Teeth	11/13T	13/13T	
	Screws material	Steel	Steel	
	Sunken type pulley screw	√	√	
Bracket	Material	-	-	
	Finish	-	-	
B-axle	Hollow axle	-	-	
	Material	Stainless steel	Stainless steel	
	Finish	-	-	
B-axle 2	Hollow axle	-	-	
	Material	-	-	
	Finish	-	-	
Bracket body	Material	Aluminum	Aluminum	
	Finish	Painted	Painted	
P-axle	Material	Steel	Steel	
	Finish	-	-	
Plate body	Material	PA+GF	PA+GF	
	Finish	-	-	
Outer link	Material	PA+GF	PA+GF	
	Finish	Painted	-	
Inner link	Material	PA+GF	Aluminum	
	Finish	-	Painted	
Outer plate	Material	Steel	Steel	
	Finish	Painted	Painted	
Inner plate	Material	Steel	Steel	
	Finish	Painted	Painted	
Cable fixing screw	Material	Stainless steel	Stainless steel	
	Finish	-	-	
Stroke adjusting screw	Material	Steel	Steel	
	Finish	Plated	Plated	
Average weight (g)		-	-	
Note		E-bike rated	E-bike rated	

LINKGLIDE 11/10/9-speed drivetrain

SHIMANO
CUES



RD-U4020



RD-U4020 NEW

SHIMANO CUES SHADOW RD Rear Derailleur 9-speed

- Stable drivetrain performance on trails, gravel, and city streets
 - » Low-profile design protects rear derailleur from obstacles in a wide variety of riding scenes
 - » Total capacity: 41T
 - » Max low sprocket: 36T (2x9-speed)
- Designed and tested to provide enduring e-biking performance
 - E-BIKE RATED

SHIMANO
CUES



RD-U3020



RD-U3020 NEW

SHIMANO CUES SHADOW RD Rear Derailleur 9-speed

- Stable drivetrain performance on trails, gravel, and city streets
 - » Low-profile design protects rear derailleur from obstacles in a wide variety of riding scenes
 - » Total capacity: 41T
 - » Max low sprocket: 36T (2x9-speed)

		NEW	NEW	v=Yes
Brand		SHIMANO CUES	SHIMANO CUES	
Model no.		RD-U4020	RD-U3020	
Color		Series color	Series color	
Rear speeds		9-speed	9-speed	
Compatible chain		LINKGLIDE, HG 11-speed	LINKGLIDE, HG 11-speed	
Top-normal spring type		SHIMANO SHADOW RD	SHIMANO SHADOW RD	
Mount		Direct attachment (conventional)	Direct attachment (conventional)	
Mode converter		-	-	
Cable adjuster		√	√	
Max. front difference		16T	16T	
Total capacity		41T	41T	
Low sprocket	Max.	36T	36T	
	Min.	36T	36T	
Top sprocket	Max.	11T	11T	
	Min.	11T	11T	
Fluoric coated link bushings		1	-	
Pulley	Guide pulley bearing	-	-	
	Tension pulley bearing	-	-	
	Teeth	11/11T	11/11T	
	Screws material	Steel	Steel	
	Sunken type pulley screw	√	√	
Bracket	Material	-	-	
	Finish	-	-	
B-axle	Hollow axle	-	-	
	Material	Stainless steel	Stainless steel	
	Finish	-	-	
B-axle 2	Hollow axle	-	-	
	Material	-	-	
	Finish	-	-	
Bracket body	Material	Aluminum	Aluminum	
	Finish	Painted	Painted	
P-axle	Material	Steel	Steel	
	Finish	-	-	
Plate body	Material	PA+GF	PA+GF	
	Finish	-	-	
Outer link	Material	PA+GF	PA+GF	
	Finish	-	-	
Inner link	Material	PA+GF	PA+GF	
	Finish	-	-	
Outer plate	Material	Steel	Steel	
	Finish	Painted	Painted	
Inner plate	Material	Steel	Steel	
	Finish	Painted	Painted	
Cable fixing screw	Material	Stainless steel	Stainless steel	
	Finish	-	-	
Stroke adjusting screw	Material	Steel	Steel	
	Finish	Plated	Plated	
Average weight [g]		-	-	
Note		E-bike rated		

√=Yes



CS-LG700-11



CS-LG700-11

SHIMANO LINKGLIDE Cassette 11-speed

- Aluminum spider significantly reduces cassette weight
- Go further with smooth and long-lasting e-biking performance
 - » Up to three times the durability of HYPERGLIDE in high chain tension conditions
- Smooth 2-way shifting (inward and outward) with reduced pedal shock
 - LINKGLIDE
- Gear combination: 11-45T: (11-13-15-17-20-23-26-30-34-39-45T), 11-50T: (11-13-15-17-20-23-26-30-36-43-50T)

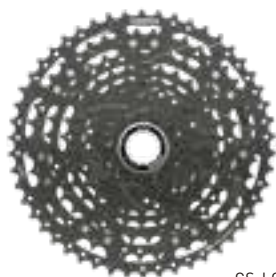

CS-LG400-11



CS-LG400-11

SHIMANO LINKGLIDE Cassette 11-speed

- Go further with smooth and long-lasting e-biking performance
 - » Up to three times the durability of HYPERGLIDE in high chain tension conditions
- Smooth 2-way shifting (inward and outward) with reduced pedal shock
 - LINKGLIDE
 - » Premium metallic design
- Gear combination: 11-45T: (11-13-15-17-20-23-26-30-34-39-45T), 11-50T: (11-13-15-17-20-23-26-30-36-43-50T)

Brand	SHIMANO	SHIMANO	
Model no.	CS-LG700-11	CS-LG400-11	
Type	LINKGLIDE	LINKGLIDE	
Rear speeds	11-speed	11-speed	
Compatible chain	LINKGLIDE, HG 11-speed	LINKGLIDE, HG 11-speed	
Combination name (Group name)	11-45T NEW 11-50T	11-45T NEW 11-50T	
Combination * Titanium gear	1	11-13-15-17-20-23-26-30-34-39-45T	11-13-15-17-20-23-26-30-34-39-45T
	2	11-13-15-17-20-23-26-30-36-43-50T	11-13-15-17-20-23-26-30-36-43-50T
	3	-	-
	4	-	-
	5	-	-
	6	-	-
	7	-	-
Spline type	MICRO SPLINE	-	-
	HG spline L2 (ROAD 12-speed dedicated)	-	-
	HG spline L (ROAD 12/11-speed)	-	-
	HG spline M (10/9/8-speed, MTB 11-speed)	√ *	√ *
	HG spline S (7-speed)	-	-
Carbon spider arm	QTY (pcs)	-	-
	Finish	-	-
Aluminum spider arm	QTY (pcs)	1	-
	Finish	Painted	-
Steel spider arm	QTY (pcs)	-	-
	Finish	-	-
Titanium gear	QTY (pcs)	-	-
	Finish	-	-
Aluminum gear	QTY (pcs)	-	-
	Finish	-	-
Steel gear	QTY (pcs)	11	11
	Finish	Plated	Plated
Lock ring	Material	Aluminum	Steel
	Finish	Anodized	Plated
Note	* Refer to compatibility chart.	* Refer to compatibility chart.	

LINKGLIDE 11/10/9-speed drivetrain



CS-LG400-10
LINKGLIDE

CS-LG400-10

SHIMANO LINKGLIDE Cassette 10-speed

- Go further with smooth and long-lasting e-biking performance
 - » Up to three times the durability of HYPERGLIDE in high chain tension conditions
- Smooth 2-way shifting (inward and outward) with reduced pedal shock
 - LINKGLIDE
 - » Premium metallic design
- Gear combination: 11-39T: (11-13-15-17-20-23-26-30-34-39T), 11-43T: (11-13-15-17-20-23-26-30-36-43T), 11-48T: (11-13-15-17-20-23-28-34-41-48T)



CS-LG300-10
LINKGLIDE

CS-LG300-10 NEW

SHIMANO LINKGLIDE Cassette 10-speed

- Go further with smooth and long-lasting e-biking performance
 - » Up to three times the durability of HYPERGLIDE in high chain tension conditions
- Smooth 2-way shifting (inward and outward) with reduced pedal shock
 - LINKGLIDE
- Gear combination: 11-39T: (11-13-15-17-20-23-26-30-34-39T), 11-48T: (11-13-15-17-20-23-28-34-41-48T)

NEW v=Yes

Brand		SHIMANO	SHIMANO
Model no.		CS-LG400-10	CS-LG300-10
Type		LINKGLIDE	LINKGLIDE
Rear speeds		10-speed	10-speed
Compatible chain		LINKGLIDE, HG 11-speed	LINKGLIDE, HG 11-speed
Combination name (Group name)		11-39T NEW 11-43T 11-48T NEW	11-39T 11-48T
Combination * Titanium gear	1	11-13-15-17-20-23-26-30-34-39T	11-13-15-17-20-23-26-30-34-39T
	2	11-13-15-17-20-23-26-30-36-43T	11-13-15-17-20-23-28-34-41-48T
	3	11-13-15-17-20-23-28-34-41-48T	-
	4	-	-
	5	-	-
	6	-	-
	7	-	-
Spline type	MICRO SPLINE	-	-
	HG spline L2 (ROAD 12-speed dedicated)	-	-
	HG spline L (ROAD 12/11-speed)	-	-
	HG spline M (10/9/8-speed, MTB 11-speed)	v *	v *
	HG spline S (7-speed)	-	-
Carbon spider arm	QTY (pcs)	-	-
	Finish	-	-
Aluminum spider arm	QTY (pcs)	-	-
	Finish	-	-
Steel spider arm	QTY (pcs)	-	-
	Finish	-	-
Titanium gear	QTY (pcs)	-	-
	Finish	-	-
Aluminum gear	QTY (pcs)	-	-
	Finish	-	-
Steel gear	QTY (pcs)	10	10
	Finish	Plated	MnPO4
Lock ring	Material	Steel	Steel
	Finish	Plated	MnPO4
Note		* Refer to compatibility chart.	* Refer to compatibility chart.



CS-LG400-9
LINKGLIDE

CS-LG400-9 **NEW**

SHIMANO LINKGLIDE Cassette 9-speed

- Go further with smooth and long-lasting e-biking performance
 - » Up to three times the durability of HYPERGLIDE in high chain tension conditions
- Smooth 2-way shifting (inward and outward) with reduced pedal shock
 - LINKGLIDE
 - » Premium metallic design
- Gear combination: 11-36T: (11-13-15-17-20-23-26-30-36T), 11-41T: (11-13-15-17-20-23-28-34-41T), 11-46T: (11-13-15-17-20-23-28-36-46T)



CS-LG300-9
LINKGLIDE

CS-LG300-9 **NEW**

SHIMANO LINKGLIDE Cassette 9-speed

- Go further with smooth and long-lasting e-biking performance
 - » Up to three times the durability of HYPERGLIDE in high chain tension conditions
- Smooth 2-way shifting (inward and outward) with reduced pedal shock
 - LINKGLIDE
- Gear combination: 11-36T: (11-13-15-17-20-23-26-30-36T), 11-41T: (11-13-15-17-20-23-28-34-41T), 11-46T: (11-13-15-17-20-23-28-36-46T)



CN-LG500
LINKGLIDE

CN-LG500

LINKGLIDE Chain (10/11-speed)

- Smooth and reliable shift performance
 - LINKGLIDE technology
 - » Compatible with LINKGLIDE 10/11-speed and 11-speed HYPERGLIDE drivetrain system
- Weight: 257 g

		NEW	NEW	v=Yes
Brand		SHIMANO	SHIMANO	
Model no.		CS-LG400-9	CS-LG300-9	
Type		LINKGLIDE	LINKGLIDE	
Rear speeds		9-speed	9-speed	
Compatible chain		LINKGLIDE, HG 11-speed	LINKGLIDE, HG 11-speed	
Combination name (Group name)		11-36T 11-41T 11-46T	11-36T 11-41T 11-46T	
Combination * Titanium gear	1	11-13-15-17-20-23-26-30-36T	11-13-15-17-20-23-26-30-36T	
	2	11-13-15-17-20-23-28-34-41T	11-13-15-17-20-23-28-34-41T	
	3	11-13-15-17-20-23-28-36-46T	11-13-15-17-20-23-28-36-46T	
	4	-	-	
	5	-	-	
	6	-	-	
	7	-	-	
Spline type	MICRO SPLINE	-	-	
	HG spline L2 (ROAD 12-speed dedicated)	-	-	
	HG spline L (ROAD 12/11-speed)	-	-	
	HG spline M (10/9/8-speed, MTB 11-speed)	√ *	√ *	
	HG spline S (7-speed)	-	-	
Carbon spider arm	QTY (pcs)	-	-	
	Finish	-	-	
Aluminum spider arm	QTY (pcs)	-	-	
	Finish	-	-	
Steel spider arm	QTY (pcs)	-	-	
	Finish	-	-	
Titanium gear	QTY (pcs)	-	-	
	Finish	-	-	
Aluminum gear	QTY (pcs)	-	-	
	Finish	-	-	
Steel gear	QTY (pcs)	9	9	
	Finish	Plated	MnP04	
Lock ring	Material	Steel	Steel	
	Finish	Plated	MnP04	
Note		* Refer to compatibility chart.	* Refer to compatibility chart.	

		v=Yes
Brand		SHIMANO
Model no.		CN-LG500
Type		LINKGLIDE
E-BIKE rear derailleur system compatible		√
Pin link plate		Gray
Roller link plate		Gray
Roller		-
Chromizing treatment roller link pin		√
Hollow pin		-
Average weight (g) (114 links)		257
Note		

NEW LIFESTYLE 12/11/10/9-speed Hub set



HB-QC400
CENTER LOCK

HB-QC400 NEW
SHIMANO CENTER LOCK Disc Brake Front Hub
100 mm Quick Release

- Long-lasting performance
 - » Easy disc brake rotor installation with spline mount and lock ring
 - » Quick release type
 - » High-quality seal
- O.L.D.: 100 mm
 - » #13 and #14 spoke compatible
 - » Optional disc brake rotor mount cover



HB-QC300
CENTER LOCK

HB-QC300 NEW
SHIMANO CENTER LOCK Disc Brake Front Hub
100 mm Quick Release

- Durable, long-lasting performance
 - » Easy disc brake rotor installation with spline mount and lock ring
 - » Quality construction prevents axle bending
 - » O.L.D.: 100 mm
 - » Disc brake rotor mount cover option
 - » #13 and #14 spoke compatible

		NEW	NEW	NEW	NEW	v=Yes
Brand		SHIMANO	SHIMANO	SHIMANO	SHIMANO	
Model no.		HB-QC400	HB-QC300	HB-TC500-15	HB-TC500-15-B	
Color	1 Hub Shell	Black	Black	Black	Black	
	1 Quick release	Black	Black	-	-	
	2 Hub Shell	Silver	-	-	-	
	2 Quick release	Black	-	-	-	
Brake type		CENTER LOCK disc brake	CENTER LOCK disc brake	CENTER LOCK disc brake	CENTER LOCK disc brake	
O.L.D. (mm)		100	100	100	100	
Spoke hole	28H	-	√	√	√	
	32H	√	√	√	√	
	36H	√	√	√	√	
External serration disc brake rotor lock ring	With	-	-	-	-	
	Without	√	√	√	√	
CENTER LOCK mount cover option		√	√	-	-	
Axle fixing method		Quick release	Quick release	15 mm E-THRU	15 mm E-THRU	
Quick release skewer length (mm)	129	-	√	-	-	
	133	√	√	-	-	
Thru axle (length x inner diameter ; mm)	100 x 15	-	-	√	-	
	110 x 15	-	-	-	√	
	110 x 20	-	-	-	-	
Flange distance (mm)		60.2	60.2	60.2	70.2	
Offset (mm)		5.3	5.3	5.3	5.3	
P.C.D. left/right (mm)		44/44	44/44	44/44	44/44	
Flange diameter left/right (mm)		52.8	52.8 (32H/36H), 53.8 (28H)	52.8	52.8	



HB-TC500-15

**HB-TC500-15** NEWSHIMANO CENTER LOCK Disc Brake Front Hub
100x15 mm E-THRU Axle

- Simple setup and reliable trail performance
 - » Easy disc brake rotor installation with spline mount and lock ring
 - » Stiff and lightweight 15 mm E-THRU skewer system
 - » Labyrinth & Contact Sealing
- O.L.D.: 100 mm
 - » #13 and #14 spoke compatible



HB-TC500-15-B

**HB-TC500-15-B** NEWSHIMANO CENTER LOCK Disc Brake Front Hub
110x15 mm E-THRU Axle

- Simple setup and reliable trail performance
 - » Easy disc brake rotor installation with spline mount and lock ring
 - » Stiff and lightweight 15 mm E-THRU skewer system
 - » Labyrinth & Contact Sealing
- O.L.D.: 110 mm
 - » #13 and #14 spoke compatible

		NEW	NEW	NEW	NEW	√=Yes
Brand		SHIMANO	SHIMANO	SHIMANO	SHIMANO	
Model no.		HB-QC400	HB-QC300	HB-TC500-15	HB-TC500-15-B	
Seal		Contact	Contact	Labyrinth+Contact	Labyrinth+Contact	
Internal grease sleeve		-	-	-	-	
Bearing	Stainless ball	-	-	-	-	
	Cup	-	-	-	-	
	Cone	-	-	-	-	
	Cartridge	√	-	√	√	
Hub shell	Material	Aluminum	Aluminum	Aluminum	Aluminum	
	Finish	Painted	Painted	Anodized	Anodized	
Axle	Material	Steel	Steel	-	-	
	Finish	-	-	-	-	
Quick release lever	Material	Aluminum	Steel	-	-	
	Finish	Plated	Plated	-	-	
Quick release housing	Material	Steel	Steel	-	-	
	Finish	Plated	Plated	-	-	
Quick release nut	Material	Steel+resin	Steel+resin	-	-	
	Finish	-	-	-	-	
Disc brake rotor lock ring	Material	-	-	-	-	
	Finish	-	-	-	-	
Average weight (g)		-	-	-	-	
Note						

NEW LIFESTYLE 12/11/10/9-speed Hub set



FH-QC500-MS



FH-QC500-MS-B



FH-QC400-HM

FH-QC500-MS NEW
 SHIMANO CENTER LOCK Disc Brake Rear
 FREEHUB 135 mm Quick Release 12-speed
 MICRO SPLINE

- Simple setup and reliable trail performance
 - » Easy disc brake rotor installation with spline mount and lock ring
 - » Quick release type
 - » Labyrinth & Contact Sealing
 - » Smaller spline diameter for 10T top gear
- O.L.D.: 135 mm
 - » #13 and #14 spoke compatible

FH-QC500-MS-B NEW
 SHIMANO CENTER LOCK Disc Brake Rear
 FREEHUB 141 mm Quick Release 12-speed
 MICRO SPLINE

- Simple setup and reliable trail performance
 - » Easy disc brake rotor installation with spline mount and lock ring
 - » Quick release type
 - » Labyrinth & Contact Sealing
 - » Smaller spline diameter for 10T top gear
- O.L.D.: 141 mm
 - » #13 and #14 spoke compatible

FH-QC400-HM NEW
 SHIMANO CENTER LOCK Disc Brake
 Rear FREEHUB 135 mm Quick Release
 11/10/9/8-speed HG spline M

- Long-lasting performance
 - » High-quality seal
 - » Easy disc brake rotor installation with spline mount and lock ring
- O.L.D.: 135 mm
 - » #13 and #14 spoke compatible
 - » Disc brake rotor mount cover option

√=Yes

		NEW	NEW	NEW	NEW	NEW	NEW
Brand		SHIMANO	SHIMANO	SHIMANO	SHIMANO	SHIMANO	SHIMANO
Model no.		FH-QC500-MS	FH-QC500-MS-B	FH-QC400-HM	FH-QC300-HM	FH-TC600-HM-B	FH-TC600-MS-B
Color	1 Hub Shell	Black	Black	Black	Black	Black	Black
	1 Quick release	Black	Black	Black	Black	-	-
Brake type		CENTER LOCK disc brake	CENTER LOCK disc brake	CENTER LOCK disc brake	CENTER LOCK disc brake	CENTER LOCK disc brake	CENTER LOCK disc brake
Rear speeds		12	12	11/10/9/8	11/10/9/8	11/10/9/8	12
O.L.D. (mm)		135	141	135	135	148	148
Spoke hole	24H	-	-	-	-	-	-
	28H	√	√	-	-	√	√
	32H	√	√	√	√	√	√
	36H	√	√	√	√	√	√
10 tooth cog compatible		√	√	-	-	-	√
External serration disc brake rotor lock ring	With	-	-	-	-	-	-
	Without	√	√	√	√	√	√
Internal serration disc brake rotor lock ring	With	-	-	-	-	-	-
	Without	√	√	√	√	√	√
CENTER LOCK mount cover option		-	-	√	√	-	-
Axle fixing method		Quick release	Quick release	Quick release	Quick release	12 mm E-THRU	12 mm E-THRU
Quick release skewer length (mm)	166	-	-	-	√	-	-
	168	√	-	√	-	-	-
	170	-	-	-	√	-	-
	172	-	-	-	-	-	-
	173	√	-	√	-	-	-
	174	-	√	-	-	-	-
	176	-	-	-	-	-	-
	178	-	√	-	-	-	-
Thru axle (length x inner diameter ; mm)	135 x 10	-	-	-	-	-	-
	135 x 12	-	-	-	-	-	-
	142 x 12	-	-	-	-	-	-
	148 x 12	-	-	-	-	√	√
	150 x 12	-	-	-	-	-	-
	157 x 12	-	-	-	-	-	-
Flange distance (mm)		55.45	61.45	55.45	55.45	61.1	61.1
Offset (mm)		7.7	7.7	7.45	7.4	7.19	7.19
P.C.D. left/right (mm)		50.5/51.5	50.5/51.5	45/45	45/45	60/61	60/61
Flange diameter left/right (mm)		59.3/60.3	59.3/60.3	53.8/53.8	53.8	68.8/69.8	68.8/69.8



FH-QC300-HM

**FH-QC300-HM** NEW

SHIMANO CENTER LOCK Disc Brake Rear FREEHUB Quick Release 11/10/9/8-speed

- Durable, long-lasting performance
 - » Easy disc brake rotor installation with spline mount and lock ring
 - » Quality construction prevents axle bending
 - » O.L.D.: 135 mm
 - » Disc brake rotor mount cover option
 - » #13 and #14 spoke compatible



FH-TC600-HM-B

**FH-TC600-HM-B** NEW

SHIMANO CENTER LOCK Disc Brake Rear FREEHUB 148x12 mm E-THRU Axle 11/10/9/8-speed HG spline M

- Simple setup and reliable trail performance
 - » Easy disc brake rotor installation with spline mount and lock ring
 - » Stiff and lightweight 12 mm E-THRU skewer system
 - » Labyrinth & Contact Sealing
 - » Quick engagement
- Excellent durability with high pedaling torque
 - » Optimal bearing positioning for reliable e-bike and high torque usage
 - » O.L.D.: 148 mm
 - » #13 and #14 spoke compatible



FH-TC600-MS-B

**FH-TC600-MS-B** NEW

SHIMANO CENTER LOCK Disc Brake Rear FREEHUB 148x12 mm E-THRU Axle 12-speed MICRO SPLINE

- Simple setup and reliable trail performance
 - » Easy disc brake rotor installation with spline mount and lock ring
 - » Stiff and lightweight 12 mm E-THRU skewer system
 - » Labyrinth & Contact Sealing
 - » Quick engagement
- Excellent durability with high pedaling torque
 - » Optimal bearing positioning for reliable e-bike and high torque usage
 - » Smaller spline diameter for 10T top gear
 - » O.L.D.: 148 mm
 - » #13 and #14 spoke compatible

√=Yes

		NEW	NEW	NEW	NEW	NEW	NEW
Brand		SHIMANO	SHIMANO	SHIMANO	SHIMANO	SHIMANO	SHIMANO
Model no.		FH-QC500-MS	FH-QC500-MS-B	FH-QC400-HM	FH-QC300-HM	FH-TC600-HM-B	FH-TC600-MS-B
Spline type	MICRO SPLINE	√	√	-	-	-	√
	HG spline L2 (ROAD 12-speed dedicated)	-	-	-	-	-	-
	HG spline L (ROAD 12/11-speed)	-	-	-	-	-	-
	HG spline M (10/9/8-speed, MTB 11-speed)	-	-	√	√	√	-
	HG spline S (7-speed)	-	-	-	-	-	-
Engagement type		Pawl ratchet	Pawl ratchet	Pawl ratchet	Pawl ratchet	Pawl ratchet	Pawl ratchet
Quick engagement		-	-	-	-	√ (36 times/360°)	√ (36 times/360°)
Seal	Hub	Labyrinth+Contact	Labyrinth+Contact	Contact	Contact	Labyrinth+Contact	Labyrinth+Contact
	FREEHUB body	Contact	Contact	-	-	Contact	Contact
Internal grease sleeve		-	-	-	-	-	-
Digital Adjustment system		-	-	-	-	-	-
Bearing	Stainless ball	-	-	-	-	-	-
	Cup	-	-	-	-	-	-
	Cone	-	-	-	-	-	-
	Cartridge	√	√	√	-	√	√
FREEHUB body	Material	Steel	Steel	Steel	Steel	Steel	Steel
	Finish	-	-	-	-	-	-
Hub shell	Material	Aluminum	Aluminum	Aluminum	Aluminum	Aluminum	Aluminum
	Finish	Anodized	Anodized	Painted	Painted	Anodized	Anodized
Axle	Material	Steel	Steel	Steel	Steel	Aluminum	Aluminum
	Finish	-	-	-	-	-	-
Quick release lever	Material	Aluminum	Aluminum	Aluminum	Steel	-	-
	Finish	Painted	Painted	Plated	Plated	-	-
	Color	Black	Black	Black	Black	-	-
Quick release housing	Material	Steel	Steel	Steel	Steel	-	-
	Finish	Painted	Painted	Plated	Plated	-	-
Quick release nut	Material	Steel+resin	Steel+resin	Steel+resin	Steel+resin	-	-
	Finish	-	-	-	-	-	-
Disc brake rotor lock ring	Material	-	-	-	-	-	-
	Finish	-	-	-	-	-	-
Average weight [g] (w/o axle, quick release nor lock ring)		-	-	-	-	-	-
Note							

NEW LIFESTYLE 12/11/10/9-speed Hub set



FH-TC500-HM



FH-TC500-HM **NEW**

SHIMANO CENTER LOCK Disc Brake
Rear FREEHUB 142x12 mm E-THRU Axle
11/10/9/8-speed HG spline M

- Simple setup and reliable trail performance
 - » Easy disc brake rotor installation with spline mount and lock ring
 - » Stiff and lightweight 12 mm E-THRU skewer system
 - » Labyrinth & Contact Sealing
- O.L.D.: 142 mm
 - » #13 and #14 spoke compatible



FH-TC500-HM-B



FH-TC500-HM-B **NEW**

SHIMANO CENTER LOCK Disc Brake
Rear FREEHUB 148x12 mm E-THRU Axle
11/10/9/8-speed HG spline M

- Simple setup and reliable trail performance
 - » Easy disc brake rotor installation with spline mount and lock ring
 - » Stiff and lightweight 12 mm E-THRU skewer system
 - » Labyrinth & Contact Sealing
- O.L.D.: 148 mm
 - » #13 and #14 spoke compatible

		NEW	NEW	NEW	NEW	v=Yes
Brand		SHIMANO	SHIMANO	SHIMANO	SHIMANO	SHIMANO
Model no.		FH-TC500-HM	FH-TC500-HM-B	FH-TC500-MS	FH-TC500-MS-B	FH-UR600
Color	1 Hub Shell	Black	Black	Black	Black	Black
	1 Quick release	-	-	-	-	Black
Brake type		CENTER LOCK disc brake	CENTER LOCK disc brake	CENTER LOCK disc brake	CENTER LOCK disc brake	CENTER LOCK disc brake
Rear speeds		11/10/9/8	11/10/9/8	12	12	11/10 *
O.L.D. (mm)		142	148	142	148	135
Spoke hole	24H	-	-	-	-	-
	28H	√	√	√	√	-
	32H	√	√	√	√	√
	36H	√	√	√	√	√
10 tooth cog compatible		-	-	√	√	-
External serration disc brake rotor lock ring	With	-	-	-	-	-
	Without	√	√	√	√	√
Internal serration disc brake rotor lock ring	With	-	-	-	-	-
	Without	√	√	√	√	√
CENTER LOCK mount cover option		-	-	-	-	√
Axle fixing method		12 mm E-THRU	12 mm E-THRU	12 mm E-THRU	12 mm E-THRU	Quick release
Quick release skewer length (mm)	166	-	-	-	-	-
	168	-	-	-	-	√
	170	-	-	-	-	-
	172	-	-	-	-	√
	173	-	-	-	-	-
	174	-	-	-	-	-
	176	-	-	-	-	-
	178	-	-	-	-	-
Thru axle (length x inner diameter ; mm)	135 x 10	-	-	-	-	-
	135 x 12	-	-	-	-	-
	142 x 12	√	-	√	-	-
	148 x 12	-	√	-	√	-
	150 x 12	-	-	-	-	-
	157 x 12	-	-	-	-	-
Flange distance (mm)		55.45	61.45	55.45	61.45	55.7
Offset (mm)		7.7	7.7	7.7	7.7	7.45
P.C.D. left/right (mm)		50.5/51.5	50.5/51.5	50.5/51.5	50.5/51.5	44.6/44.6
Flange diameter left/right (mm)		59.3/60.3	59.3/60.3	59.3/60.3	59.3/60.3	53.5/53.8



FH-TC500-MS



FH-TC500-MS NEW

SHIMANO CENTER LOCK Disc Brake Rear
FREEHUB 142x12 mm E-THRU Axle 12-speed
MICRO SPLINE

- Simple setup and reliable trail performance
 - » Easy disc brake rotor installation with spline mount and lock ring
 - » Stiff and lightweight 12 mm E-THRU skewer system
 - » Labyrinth & Contact Sealing
 - » Smaller spline diameter for 10T top gear
- O.L.D.: 142 mm
 - » #13 and #14 spoke compatible



FH-TC500-MS-B



FH-TC500-MS-B NEW

SHIMANO CENTER LOCK Disc Brake Rear
FREEHUB 148x12 mm E-THRU Axle 12-speed
MICRO SPLINE

- Simple setup and reliable trail performance
 - » Easy disc brake rotor installation with spline mount and lock ring
 - » Stiff and lightweight 12 mm E-THRU skewer system
 - » Labyrinth & Contact Sealing
 - » Smaller spline diameter for 10T top gear
- O.L.D.: 148 mm
 - » #13 and #14 spoke compatible



FH-UR600



FH-UR600

Rear FREEHUB for Disc Brake

- Access the smooth and reliable shift performance of LINKGLIDE.
 - » Compatible with 11/10-speed, O.L.D. 135 mm
 - » Durable construction
 - » Included FREEHUB spacer required for use with LINKGLIDE cassettes
 - » Compatible with #13 spoke
- Weight: 381 g

		NEW	NEW	NEW	NEW	√=Yes
Brand		SHIMANO	SHIMANO	SHIMANO	SHIMANO	SHIMANO
Model no.		FH-TC500-HM	FH-TC500-HM-B	FH-TC500-MS	FH-TC500-MS-B	FH-UR600
Spline type	MICRO SPLINE	-	-	√	√	-
	HG spline L2 (ROAD 12-speed dedicated)	-	-	-	-	-
	HG spline L (ROAD 12/11-speed)	-	-	-	-	√
	HG spline M (10/9/8-speed, MTB 11-speed)	√	√	-	-	-
	HG spline S (7-speed)	-	-	-	-	-
Engagement type		Pawl ratchet	Pawl ratchet	Pawl ratchet	Pawl ratchet	Pawl ratchet
Quick engagement		-	-	-	-	-
Seal	Hub	Labyrinth+Contact	Labyrinth+Contact	Labyrinth+Contact	Labyrinth+Contact	Contact
	FREEHUB body	Contact	Contact	Contact	Contact	Contact
Internal grease sleeve		-	-	-	-	√
Digital Adjustment system		-	-	-	-	-
Bearing	Stainless ball	-	-	-	-	-
	Cup	-	-	-	-	Polish
	Cone	-	-	-	-	CBN
	Cartridge	√	√	√	√	-
FREEHUB body	Material	Steel	Steel	Steel	Steel	Steel
	Finish	-	-	-	-	-
Hub shell	Material	Aluminum	Aluminum	Aluminum	Aluminum	Aluminum
	Finish	Anodized	Anodized	Anodized	Anodized	Anodized
Axle	Material	Steel	Steel	Steel	Steel	Steel
	Finish	-	-	-	-	-
Quick release lever	Material	-	-	-	-	Aluminum
	Finish	-	-	-	-	Anodized
	Color	-	-	-	-	-
Quick release housing	Material	-	-	-	-	Aluminum
	Finish	-	-	-	-	Anodized
Quick release nut	Material	-	-	-	-	Steel+resin
	Finish	-	-	-	-	Black
Disc brake rotor lock ring	Material	-	-	-	-	-
	Finish	-	-	-	-	-
Average weight (g) (w/o axle, quick release nor lock ring)		-	-	-	-	-
Note						* Used with an additional spacer.

Hub set recommendation by bike type

FREEHUB Model	E-bike with ≥ 85 N·m torque	E-bike with < 85 N·m torque	MTB enthusiastic	Trekking/ Fitness/City	Single-track cargo	Multi-track cargo	Front hub combination
FH-TC600-HM-B FH-TC600-MS-B	☆☆☆	☆☆☆	☆☆☆	☆☆☆	☆☆☆	-	HB-TC500-15 HB-TC500-15-B
FH-TC500-HM-B FH-TC500-HM FH-TC500-MS-B FH-TC500-MS FH-QC500-MS-B FH-QC500-MS	☆☆	☆☆☆	☆☆	☆☆☆	☆☆	-	
FH-QC400-HM	☆	☆☆	☆	☆☆☆	☆☆	-	HB-QC400
FH-QC300-HM	☆	☆	☆	☆☆	☆	-	HB-QC300

☆☆☆ = Excellent Performance, ☆☆ = Good Performance, ☆ = Compatible, - = Incompatible

How to find specification from model no.



No.	Spec	Details
1	Product	HB = Front hub FH = FREEHUB
2	Axle type	T = THRU type Q = Quick release N = Nut type
3	Brake type	C = CENTER LOCK type B = 6-bolt type R = Hub roller brake N = Normal type
4	Grade	600/500/400/300
5	Spline	MS = MICRO SPLINE HL = HG spline long (Road 11-speed) HM = HG spline middle (MTB 11/10/9/8-speed) HS = HG spline short (HG 7-speed) SF = Single free
6	O.L.D.	B = Boost

Sealing performance of each model

Labyrinth & Contact Sealing provide reliable sealing performance in rough conditions.



Contact Sealing



Labyrinth & Contact Sealing

TC600

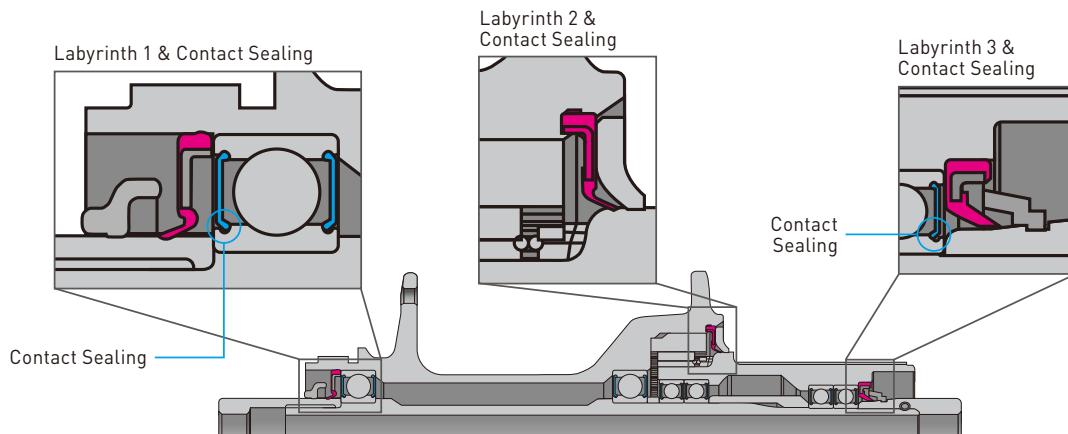

TC500/QC500

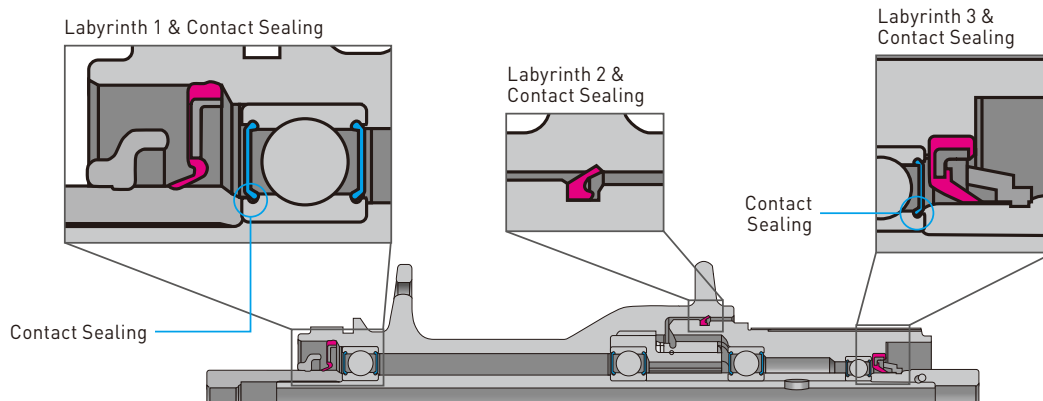

QC400

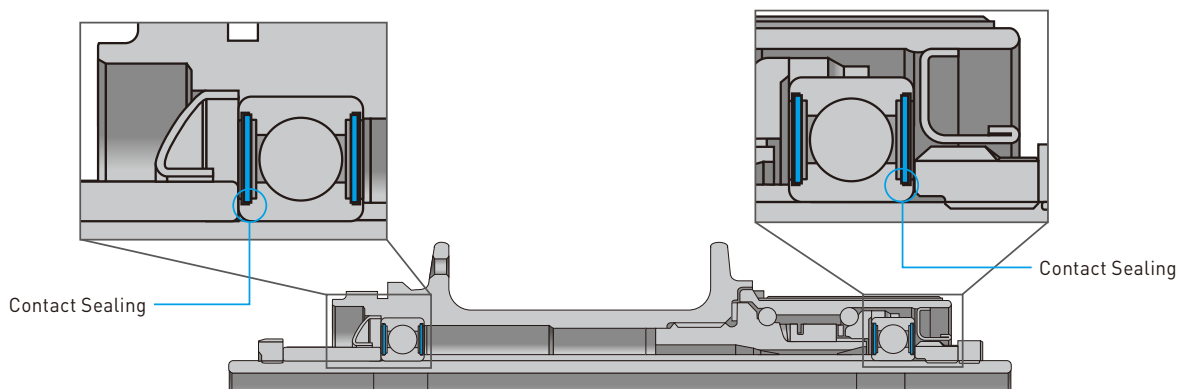

< 2nd gen. Battery Management System >

Battery



BT-EN805
Integrated Type Battery for Down Tube
(504 Wh)



BT-EN805-L
Integrated Type Battery for Down Tube
(504 Wh)



BT-EN806
Integrated Type Battery for Down Tube
(630 Wh)



BT-EN604
Battery for Down Tube
(418 Wh)



BT-EN605
Battery for Down Tube
(504 Wh)



BT-EN606
Battery for Down Tube
(630 Wh)



BT-EN404
Battery for Rear Carrier
(418 Wh)



BT-EN405
Battery for Rear Carrier
(504 Wh)

Battery

√=Yes

Model no.		BT-EN805	BT-EN805-L	BT-EN806	BT-EN604	BT-EN605
Compatible drive unit	EP801/EP600	√	√	√	√	√
	EP800	-	-	-	-	-
	E8000/E7000	-	-	-	-	-
	E6100/E5000	-	-	-	-	-
Rated capacity (Wh)	630 Wh	-	-	√	-	-
	504 Wh	√	√	-	-	√
	418 Wh	-	-	-	√	-
Rated voltage		36	36	36	36	36
Mount type	Down tube type	-	-	-	√	√
	Seat tube type	-	-	-	√	√
	Integrated type	√	√	√	-	-
	Rear carrier type	-	-	-	-	-
Compatible battery mount		BM-EN800-A BM-EN800-B BM-EN801-A BM-EN801-B	BM-EN800-A BM-EN800-B BM-EN801-A BM-EN801-B	BM-EN800-A BM-EN800-B BM-EN801-A BM-EN801-B	BM-EN600	BM-EN600
Charge level display		√	√	√	√	√
Error signal		√	√	√	√	√
Charging port		* -	* -	* -	√	√
System on/off switch		√	√	√	√	√
Compatible charger		EC-E6002 EC-E8004	EC-E6002 EC-E8004	EC-E6002 EC-E8004	EC-E6002 EC-E8004	EC-E6002 EC-E8004
Average weight		2.9 kg	3.15 kg	3.7 kg	2.6 kg	2.55 kg

* with SM-BTE80 or EW-CP100

√=Yes

Model no.		BT-EN606	BT-EN404	BT-EN405
Compatible drive unit	EP801/EP600	√	√	√
	EP800	-	-	-
	E8000/E7000	-	-	-
	E6100/E5000	-	-	-
Rated capacity (Wh)	630 Wh	√	-	-
	504 Wh	-	-	√
	418 Wh	-	√	-
Rated voltage		36	36	36
Mount type	Down tube type	√	-	-
	Seat tube type	√	-	-
	Integrated type	-	-	-
	Rear carrier type	-	√	√
Compatible battery mount		BM-EN600	BM-EN400	BM-EN400
Charge level display		√	√	√
Error signal		√	√	√
Charging port		√	-	-
System on/off switch		√	√	√
Compatible charger		EC-E6002 EC-E8004	EC-E6002 EC-E8004	EC-E6002 EC-E8004
Average weight		3.2 kg	2.58 kg	2.65 kg

< 2nd gen. Battery Management System >

Battery mount



BM-EN800-A
Integrated Down Tube Battery
Mount With Key Unit Mount



BM-EN800-B
Integrated Down Tube Battery
Mount Without Key Unit Mount



BM-EN801-A
Integrated Down Tube Battery
Mount With Key Unit Mount



BM-EN801-B
Integrated Down Tube Battery
Mount Without Key Unit Mount



BM-EN600
Battery Mount for Down Tube



BM-EN400-A
Rear Carrier Battery Mount



BM-EN400-B
Rear Carrier Battery Mount

Battery mount

√=Yes

Model no.		BM-EN800-A	BM-EN800-B	BM-EN801-A	BM-EN801-B	BM-EN600
Color	1	Standard	Standard	Standard	Standard	Standard
	2	-	-	-	-	-
Position		Integrated	Integrated	Integrated	Integrated	Down tube/seat tube
Charging port		-	-	-	-	-
Key lock system		√	√	-	-	√
System on/off switch		-	-	-	-	-
Power cable		√	√	√	√	√
Cable length to EW-CP100 (mm)		200	-	200	-	-
Compatible battery		BT-EN805 BT-EN805-L BT-EN806	BT-EN805 BT-EN805-L BT-EN806	BT-EN805 BT-EN805-L BT-EN806	BT-EN805 BT-EN805-L BT-EN806	BT-EN604 BT-EN605 BT-EN606
Compatible tool		TL-BME04 (for BT-EN805) TL-BME05 (for BT-EN805-L/BT-EN806)	TL-BME04 (for BT-EN805) TL-BME05 (for BT-EN805-L/BT-EN806)	TL-BME04 (for BT-EN805) TL-BME05 (for BT-EN805-L/BT-EN806)	TL-BME04 (for BT-EN805) TL-BME05 (for BT-EN805-L/BT-EN806)	TL-BME02

√=Yes

Model no.		BM-EN400-A	BM-EN400-B
Color	1	Black	Black
	2	Gray	Gray
Position		Rear carrier	Rear carrier
Charging port		√	√
Key lock system		√	√
System on/off switch		-	-
Power cable		√	√
Cable length to EW-CP100 (mm)		-	-
Compatible battery		BT-EN404 BT-EN405	BT-EN404 BT-EN405
Compatible tool		-	-

Compatibility between SHIMANO STEPS battery and battery mount to 2nd generation



< 1st gen. Battery Management System >

Battery



BT-E8036
Integrated Type Battery for Down Tube
(630 Wh)



BT-E8035
Integrated Type Battery for Down Tube
(504 Wh)



BT-E8035-L
Integrated Type Battery for Down Tube
(504 Wh)



BT-E8020
Integrated Type Battery for Down Tube
(504 Wh)



BT-E8016
Battery for Down Tube
(630 Wh)



BT-E8010
Battery for Down Tube
(504 Wh)



BT-E8014
Battery for Down Tube
(418 Wh)



BT-E6001
Battery for Rear Carrier
(504 Wh)



BT-E6000
Battery for Rear Carrier
(418 Wh)

Battery

v=Yes

Model no.		BT-E8036	BT-E8035	BT-E8035-L	BT-E8020	BT-E8016
Compatible drive unit	EP801/EP600	-	-	-	-	-
	EP800	√	√	√	√	√
	E8000/E7000	√	√	√	√	√
	E6100/E5000	√	√	√	√	√
Rated capacity (Wh)	630 Wh	√	-	-	-	√
	504 Wh	-	√	√	√	-
	418 Wh	-	-	-	-	-
Rated voltage		36	36	36	36	36
Mount type	Down tube type	-	-	-	-	-
	Integrated type	√	√	√	√	-
	Rear carrier type	-	-	-	-	-
	External type	-	-	-	-	√
Compatible battery mount		BM-E8030-A BM-E8030-B BM-E8031-A BM-E8031-B	BM-E8030-A BM-E8030-B BM-E8031-A BM-E8031-B	BM-E8030-A BM-E8030-B BM-E8031-A BM-E8031-B	BM-E8020	BM-E8016
Charge level display		√	√	√	√	√
Error signal		√	√	√	√	√
Charging port		*-	*-	*-	√	√
System on/off switch		√	√	√	√	√
Compatible charger		EC-E6002 EC-E8004	EC-E6002 EC-E8004	EC-E6002 EC-E8004	EC-E6002 EC-E8004	EC-E6002 EC-E8004
Average weight		3.7 kg	2.9 kg	3.15 kg	3.05 kg	3.2 kg

* with SM-BTE80 or EW-CP100

v=Yes

Model no.		BT-E8010	BT-E8014	BT-E6001	BT-E6000
Compatible drive unit	EP801/EP600	-	-	-	-
	EP800	√	√	-	-
	E8000/E7000	√	√	-	-
	E6100/E5000	√	√	√	√
Rated capacity (Wh)	630 Wh	-	-	-	-
	504 Wh	√	-	√	-
	418 Wh	-	√	-	√
Rated voltage		36	36	36	36
Mount type	Down tube type	√	√	-	-
	Integrated type	-	-	-	-
	Rear carrier type	-	-	√	√
	External type	-	-	-	-
Compatible battery mount		BM-E8016		BM-E6000	
Charge level display		√	√	√	√
Error signal		√	√	√	√
Charging port		√	√	**-	**-
System on/off switch		√	√	√	√
Compatible charger		EC-E6002 EC-E8004	EC-E6002 EC-E8004	EC-E6002 EC-E8004	EC-E6002 EC-E8004
Average weight		2.6 kg	2.55 kg	2.65 kg	2.58 kg

** with SM-BTE60

< 1st gen. Battery Management System >

Battery mount

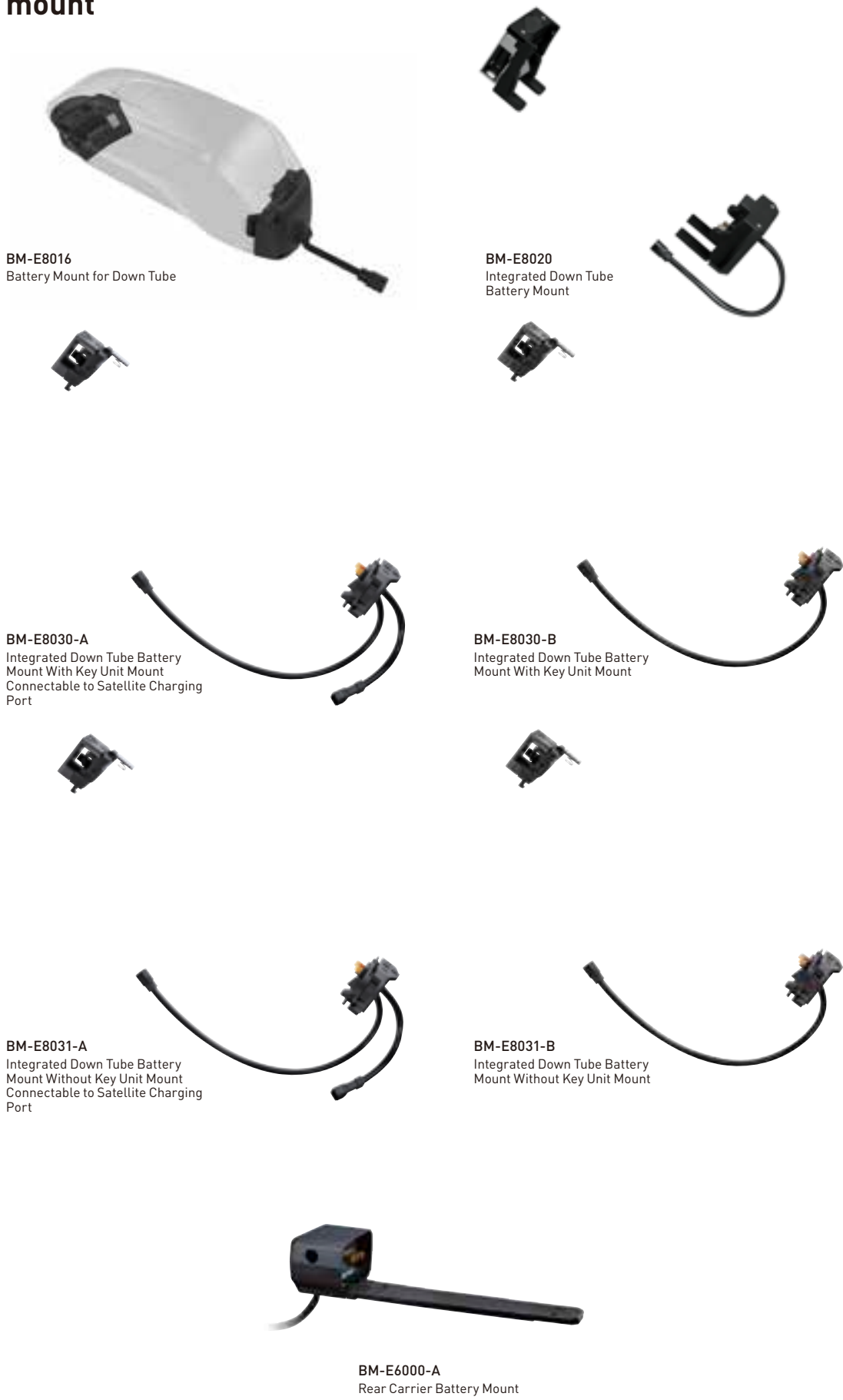

BM-E8016
Battery Mount for Down Tube

BM-E8020
Integrated Down Tube
Battery Mount

BM-E8030-A
Integrated Down Tube Battery
Mount With Key Unit Mount
Connectable to Satellite Charging
Port

BM-E8030-B
Integrated Down Tube Battery
Mount With Key Unit Mount

BM-E8031-A
Integrated Down Tube Battery
Mount Without Key Unit Mount
Connectable to Satellite Charging
Port

BM-E8031-B
Integrated Down Tube Battery
Mount Without Key Unit Mount

BM-E6000-A
Rear Carrier Battery Mount

Battery mount

√=Yes

Model no.		BM-E8016	BM-E8020	BM-E8030-A	BM-E8030-B
Color	1	Black	Black	Standard	Standard
	2	-	-	-	-
Position		Down tube/seat tube	Integrated	Integrated	Integrated
Key lock system		√	√	√	√
Connect to EW-CP100		-	-	√	-
System on/off switch		-	-	-	-
Cable length to EW-CP100 (mm)		-	-	200	-
Compatible battery		BT-E8010 BT-E8014 BT-E8016	BT-E8020	BT-E8035 BT-E8035-L BT-E8036	BT-E8035 BT-E8035-L BT-E8036
Compatible tool		TL-BME02	TL-BME03	TL-BME04 (for BT-E8035) TL-BME05 (for BT-E8035-L/ BT-E8036)	TL-BME04 (for BT-E8035) TL-BME05 (for BT-E8035-L/ BT-E8036)

√=Yes

Model no.		BM-E8031-A	BM-E8031-B	BM-E6000-A	BM-E6000-B
Color	1	Standard	Standard	Black	Black
	2	-	-	Gray	Gray
Position		Integrated	Integrated	Rear carrier	Rear carrier
Key lock system		-	-	√	√
Connect to EW-CP100		√	-	-	-
System on/off switch		-	-	-	-
Cable length to EW-CP100 (mm)		200	-	-	-
Compatible battery		BT-E8035 BT-E8035-L BT-E8036	BT-E8035 BT-E8035-L BT-E8036	BT-E6000 BT-E6001	BT-E6000 BT-E6001
Compatible tool		TL-BME04 (for BT-E8035) TL-BME05 (for BT-E8035-L/ BT-E8036)	TL-BME04 (for BT-E8035) TL-BME05 (for BT-E8035-L/ BT-E8036)	-	-

Compatibility between SHIMANO STEPS battery and battery mount to 1st generation

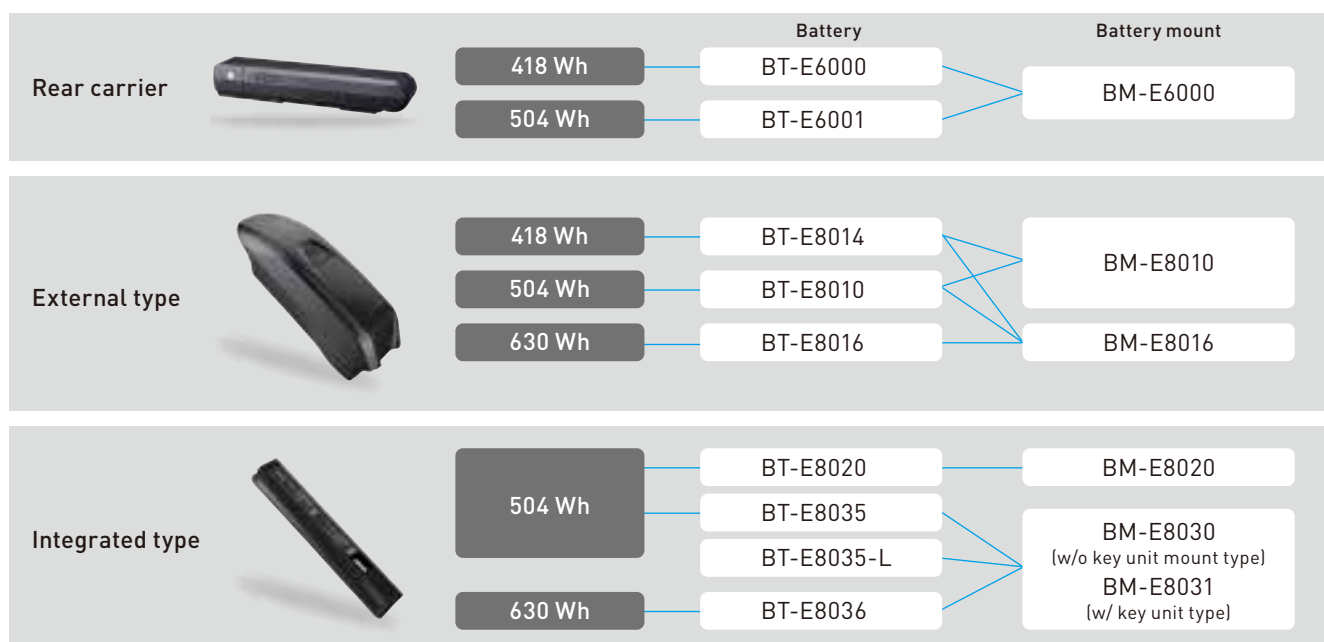

Battery charger



EC-E8004

EC-E8004

Battery Charger

- Lightweight and portable battery charger
 - » Same compact size and weight as EC-E6002
- Rapid charging
 - » Quick charge from half to 80% in 1 hour
 - » Charge from empty to 80% in 2.5 hours
 - » Go from empty to fully charged in 4.5 hours
- Equivalent or higher to waterproof grades 5 (IPX5)



SM-BTE60

SM-BTE60

Battery Charger Adapter

- Adapter for charging battery (BT-E6000/E6001/E6010) with charger (EC-E6002/E8004)



SM-BTE80

SM-BTE80

Battery Charger Adapter

- Adapter for charging battery (BT-E8035) with charger (EC-E6002/E8004)



EC-E6002



SM-BCC1

EC-E6002

Battery Charger

- Compact size & light weight for easy to bring
- Charge without removing battery
- Charge with battery directly
- Fast charging - rapid charge to 80% of total capacity
- Small connector

SM-BCC1

Battery Charger Cord

- Need to purchase separately with battery charger (EC-E6002)

Charge Time (EU/NA)

√=Yes

Model no.		EC-E8004	EC-E6002
Equipped with battery 630Wh	Full charge	4.8h/5.7h	10.2h
	80% charge	3.2h/4h	7.5h
Equipped with battery 504Wh	Full charge	4.0h/4.5h	7.5h
	80% charge	2.5h/3.2h	4h
Equipped with battery 418Wh	Full charge	3.0h/3.5h	6.5h
	80% charge	2.0h/2.5h	3.5h
Compatible voltage		AC 100 V-240 V 50-60Hz	AC 100 V-240 V 50-60Hz
Plug in charging type		√	√
Charging temperature		0-40 °C	0-40 °C
Storage temperature		-20-60 °C	-20-60 °C
Error signal		√	√
Compatible AC power cable		-	SM-BCC1
Built-in AC cable (m)		2	-
Size (mm) (LxWxH)		162x73x44	160x70x40
Average weight		550 g (target weight)	523 g

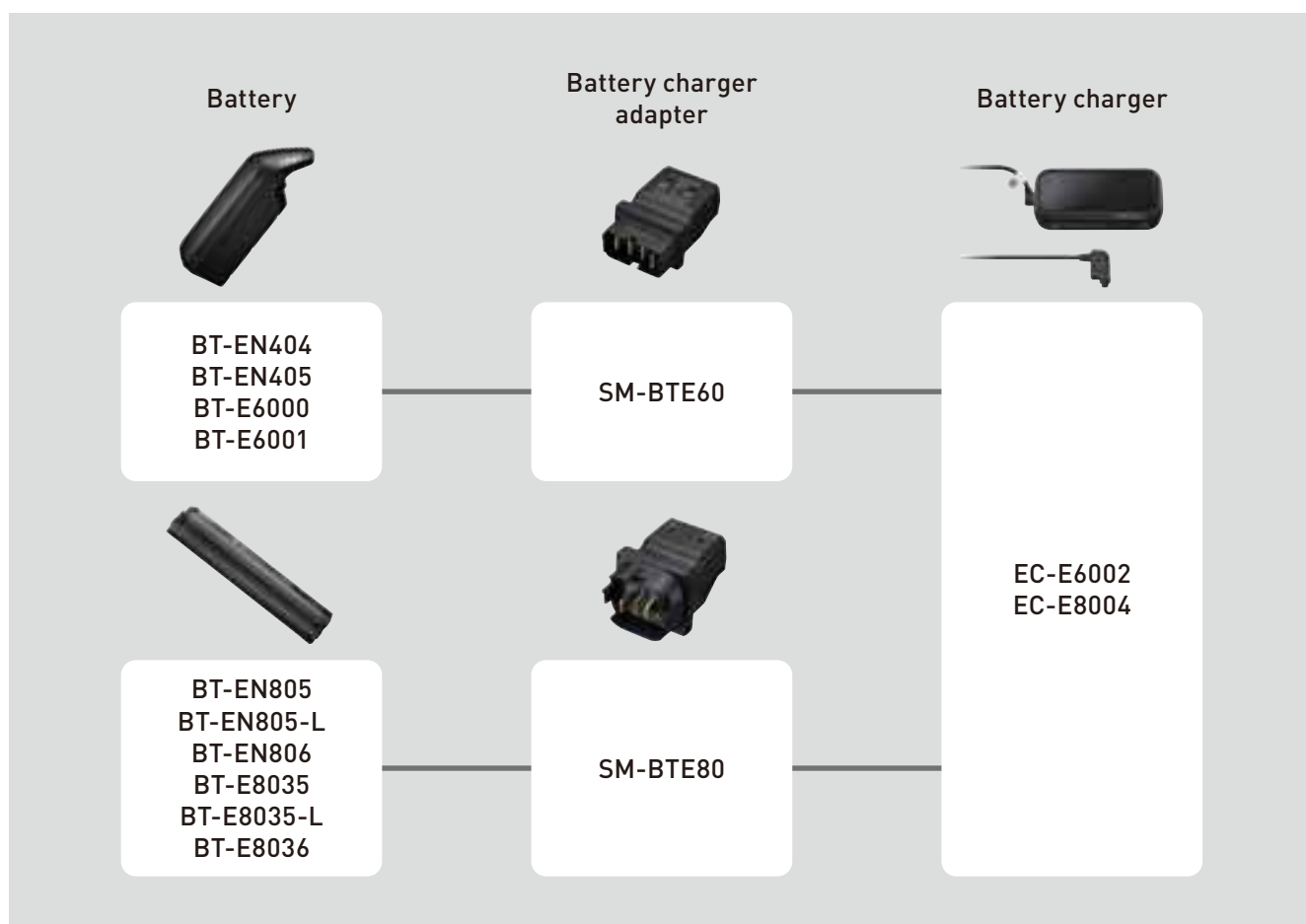

Battery charger

√=Yes

Model no.	EC-E8004-1	EC-E8004-2	EC-E8004-3	EC-E8004-4	EC-E8004-6	EC-E8004-7	EC-E8004-12	EC-E6002
Color	Standard	Standard	Standard	Standard	Standard	Standard	Standard	Standard
Plug type	Type C	Type A	Type A	Type O	Type BF	Type C	Type C	-
Typical example country/region	Europe	USA, Canada	Japan	Australia, New Zealand	UK	Korea	Brazil	Worldwide
Compatible battery	BT-E6000 BT-E6001 BT-E8010 BT-E8014 BT-E8016 BT-E8020 BT-E8035 BT-E8035-L BT-E8036 BT-EN404 BT-EN405 BT-EN604 BT-EN605 BT-EN606 BT-EN805 BT-EN805-L BT-EN806	BT-E6000 BT-E6001 BT-E8010 BT-E8014 BT-E8016 BT-E8020 BT-E8035 BT-E8035-L BT-E8036 BT-EN404 BT-EN405 BT-EN604 BT-EN605 BT-EN606 BT-EN805 BT-EN805-L BT-EN806	BT-E8010 BT-E8016 BT-E8014 BT-E8035 BT-E8035-L BT-E8036	BT-E6000 BT-E6001 BT-E8010 BT-E8014 BT-E8016 BT-E8020 BT-E8035 BT-E8035-L BT-E8036 BT-EN404 BT-EN405 BT-EN604 BT-EN605 BT-EN606 BT-EN805 BT-EN805-L BT-EN806	BT-E6000 BT-E6001 BT-E8010 BT-E8014 BT-E8016 BT-E8020 BT-E8035 BT-E8035-L BT-E8036 BT-EN404 BT-EN405 BT-EN604 BT-EN605 BT-EN606 BT-EN805 BT-EN805-L BT-EN806	BT-E6000 BT-E6001 BT-E8010 BT-E8014 BT-E8016 BT-E8020 BT-E8035 BT-E8035-L BT-E8036 BT-EN404 BT-EN405 BT-EN604 BT-EN605 BT-EN606 BT-EN805 BT-EN805-L BT-EN806	BT-E6000 BT-E6001 BT-E8010 BT-E8014 BT-E8016 BT-E8020 BT-E8035 BT-E8035-L BT-E8036 BT-EN404 BT-EN405 BT-EN604 BT-EN605 BT-EN606 BT-EN805 BT-EN805-L BT-EN806	BT-E6000 BT-E6001 BT-E8010 BT-E8014 BT-E8016 BT-E8020 BT-E8035 BT-E8035-L BT-E8036 BT-EN404 BT-EN405 BT-EN604 BT-EN605 BT-EN606 BT-EN805 BT-EN805-L BT-EN806
Compatible voltage	100 V - 240 V AC, 50 - 60 Hz	120 V AC, 50 - 60 Hz	100 V AC, 50 - 60 Hz	100 V - 240 V AC, 50 - 60 Hz	100 V - 240 V AC, 50 - 60 Hz	100 V - 240 V AC, 50 - 60 Hz	100 V - 240 V AC, 50 - 60 Hz	100 V - 240 V AC, 50 - 60 Hz
Output	42 V DC, 4 - 4.6 A	42 V DC, 4 A	42 V DC, 4 - 4.6 A	42 V DC, 4 - 4.6 A	42 V DC, 4 - 4.6 A	42 V DC, 4 - 4.6 A	42 V DC, 4 - 4.6 A	42 V DC, 1.8 A
CE standard	√	-	-	-	√	-	-	√
UL standard	-	√	-	-	-	-	-	√
Korea standard	-	-	-	-	-	√	-	√
Japan standard	-	-	√	-	-	-	-	√
Charging time for 630 Wh (583 Wh in Japan) battery	Full charge (hour)	4.8 (* 5.7)	5.7	5.7	4.8 (* 5.7)	4.8 (* 5.7)	4.8 (* 5.7)	10.2
	80% charge (hour)	3.2 (* 4)	4	4	3.2 (* 4)	3.2 (* 4)	3.2 (* 4)	7.5
Charging time for 504 Wh (464 Wh in Japan) battery	Full charge (hour)	4 (* 4.5)	4.5	4.5	4 (* 4.5)	4 (* 4.5)	4 (* 4.5)	7.5
	80% charge (hour)	2.5 (* 3.2)	3.2	3.2	2.5 (* 3.2)	2.5 (* 3.2)	2.5 (* 3.2)	4
Charging time for 418 Wh (393 Wh in Japan) battery	Full charge (hour)	3.0 (* 3.5)	3.5	3.5	3.0 (* 3.5)	3.0 (* 3.5)	3.0 (* 3.5)	6.5
	80% charge (hour)	2.0 (* 2.5)	2.5	2.5	2.0 (* 2.5)	2.0 (* 2.5)	2.0 (* 2.5)	3.5
Charging level display	-	-	-	-	-	-	-	-
Plug in charging type	√	√	√	√	√	√	√	√
Charging temperature	0 - 40 °C	0 - 40 °C	0 - 40 °C	0 - 40 °C	0 - 40 °C	0 - 40 °C	0 - 40 °C	0 - 40 °C
Storage temperature	-20 - 60 °C	-20 - 60 °C	-20 - 60 °C	-20 - 60 °C	-20 - 60 °C	-20 - 60 °C	-20 - 60 °C	-20 - 60 °C
Error signal	√	√	√	√	√	√	√	√
Adapter for battery connector	** -	* -	* -	** -	** -	** -	** -	* -
Compatible AC power cable	-	-	-	-	-	-	-	SM-BCC1
Built in AC cable	√	√	√	√	√	√	√	-
Built in AC cable length (m)	2	2	1	1	1	1	1	-
Note	* In case of 100 V AC ** Check latest line- up chart	* Check latest line- up chart	* Check latest line- up chart	* In case of 100 V AC ** Check latest line- up chart	* In case of 100 V AC ** Check latest line- up chart	* In case of 100 V AC ** Check latest line- up chart	* In case of 100 V AC ** Check latest line- up chart	* Check latest line- up chart

Charger cord



SM-BCC1
Battery Charger Cord

Model no.	SM-BCC1-1	SM-BCC1-2	SM-BCC1-3	SM-BCC1-4	SM-BCC1-5	SM-BCC1-6	SM-BCC1-7
Plug type	Type C	Type A	Type A	Type O	Type A	Type BF	Type C
Typical example country/ region	Europe	USA Canada	Japan	Australia New Zealand	China	U.K	Korea
Rated power input (V)	220/230	120	100	240	220	230/240	220
Cable length (m)	1	2	1	1	1	1	1
Note							

Model no.	SM-BCC1-8	SM-BCC1-9	SM-BCC1-10	SM-BCC1-11	SM-BCC1-12	SM-BCC1-13
Plug type	Type A	Type B3L	Type O	Type C	Type C	Type C
Typical example country/ region	Taiwan	South-Africa	Argentina	Israel	Brazil	Thailand
Rated power input (V)	110	220/230	220	230	127/220	250
Cable length (m)	1	1	1	1	1	1
Note						

Satellite system on/off switch



EW-SW310
SD300 Satellite System On/Off Switch

EW-SW300
SD300 Satellite System On/Off Switch

EW-SW100
SD50 Satellite System On/Off Switch
for E-bike

Model no.		EW-SW310	EW-SW300	EW-SW100
Battery management system compatibility	2nd gen.	√	-	-
	1st gen.	-	√	√
Position		Integrated	Integrated	Integrated
Master unit		-	-	-
Switch QTY (pcs)		2	1	1
Electric wire port	SD50 port (pcs)	0	0	0
	SD300 port (pcs)	2	0	0
Electric wire connector	SD50 type (pc)	0	0	1
	SD300 type (pc)	0	1	0
Firmware update by E-TUBE PROJECT		√	√	√
Cable length (mm)		-	1,100	1,100
Note				

Electric wire SD300 & related accessories



EW-SD300

EW-SD300

Electric Wire SD300 for External Routing

- More compact design makes new electric components smaller and lighter
- Will potentially expand the future capabilities of Di2 systems

EW-SD300-I

Electric Wire SD300 for Internal Routing

- More compact design makes new electric components smaller and lighter
- Will potentially expand the future capabilities of Di2 systems
- For internal routing usage (wire holder included)



EW-CB300-L

EW-CB300-M

EW-CB300-S

EW-CB300-L (ø35 mm)

EW-CB300-M (ø31.8 mm)

EW-CB300-S (ø22.2 mm)

Electric Wire SD300 Cord Band



EW-GM300-M

EW-GM300-S

EW-GM300-M
(7 mmx8 mm Oval)

EW-GM300-S
(6 mm Circle)

Di2 Grommet



EW-CL300-M

EW-CL300-S

EW-CL300-M
(for Brake Hose (ø5 mm))

EW-CL300-S
(for SP Outer Cable (ø4 mm))

Electric Wire SD300 Cord Clip



EW-CC300

EW-CC300

Electric Wire SD300 Cord Cover

- Cord cover length: 300 mm



EW-JC304

EW-JC302

EW-AD305

EW-JC304

Internal 4-Port Junction for EW-SD300

EW-JC302

Internal 2-Port Junction for EW-SD300

EW-AD305

Electric Wire SD300/SD50 Conversion Adaptor

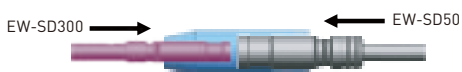

EW-SD300

EW-SD50

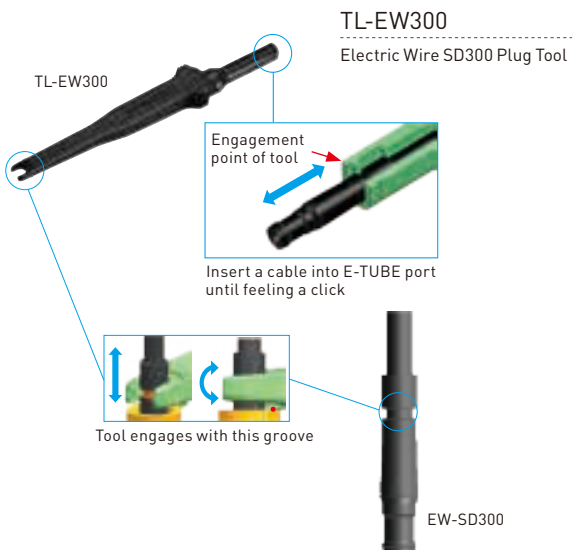

TL-EW300

TL-EW300

Electric Wire SD300 Plug Tool

Engagement point of tool

Insert a cable into E-TUBE port until feeling a click

Tool engages with this groove

EW-SD300

Electric wire SD50 & related accessories



EW-CP100

Satellite Charging Port for E-Bike

- Compact, semi-integrated frame charging port
- Cable length: 200 mm, 550 mm



EW-SD50

Electric Wire SD50

- Transmits interactive signals and power supply to each electronic components by "plug & gap" connection
- Compact and waterproof connector
- Easy to insert into frame
- Cable length 150 mm - 1600 mm
- With cable tie type for built-in cable routing (EW-SD50-I)



TL-EW02

Plug tool for connection and disconnection of Electric wire (SD50 type)

Usage	Plug tool for connection and disconnection of EW-SD50
Compatibility	EW-SD50



SM-PCE02

PC Linkage Device

- Faster and smaller than SM-PCE1
- Battery check option shows if a component's power consumption is within normal range
- Need adaptor (EW-AD305) to connect with new DU-EP800 which specs EW-SD300 electric wire

SHIMANO ABS system products

For e-MTB/e-Trekking/e-City/Small wheel bike/e-Cargo bike

* Please note that our ABS products are currently only available in the following countries:
Belgium, Denmark, Estonia, Finland, France, Iceland, Italy, Latvia, Lithuania, Luxembourg, Malta, The Netherlands, Norway, Poland, Spain, Sweden

ABS SHIMANO + blubrake



1 BS-AU301

ABS main unit for current-generation/second-generation battery management system

- Reduces front wheel lockup and rear wheel lift to retain bike stability and help it stop safely
- Single-cylinder design provides smoother pressure control for a more natural braking experience
- Quick and easy to assemble
 - » Single front wheel sensor simplifies assembly
 - » Cylindrical shape for sleek internal mounting
 - » Integrated design with internal CPU & hydraulic controller
 - » J-kit (pre-bled) shipping for quick assembly
 - » CAN port for expanded connectivity options



2 BS-SS300-C/-S

ABS speed sensor kit [CENTER LOCK]/[6-bolt disc brake rotor]

- Quick and easy-to-install front wheel speed sensor
 - » Integrated brake mount adapter
 - CENTER LOCK and 6-bolt disc brake rotor compatible



3 BS-AP301

ABS power cable (2nd-Gen battery management system)

- » Connects to the e-bike motor's power source
- Easy to install with multiple cable length options
 - » Longer cable length options for E-Cargo



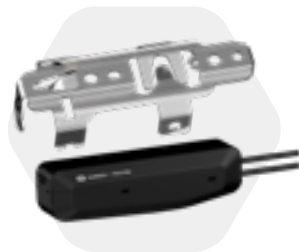

4 BS-AS300-I

ABS main unit fixing parts

» Internal mount type



4 BS-AS300-O

ABS main unit fixing parts (w/ internal mount adaptor)

» External mount type



7 DU-EP800

EP8 Drive Unit

7 DU-EP800-CRG

Drive Unit for Cargo Bike Use

7 DU-EP801

EP8 Drive Unit

7 DU-EP600

EP6 Drive Unit

8 BR-MT200

SHIMANO Hydraulic Disc Brake 2-Piston MTB Caliper

8 BR-MT420

SHIMANO Hydraulic Disc Brake 4-Piston Caliper

5 SM-PCEBS

ABS system PC linkage device

» For initial ABS activation and setup

- Service mode for error diagnosis and troubleshooting

5 AP-BSA10-0

ABS service software

6 SC-EN600

SHIMANO STEPS Cycle Computer

6 SC-EN610

SHIMANO STEPS Cycle Computer



SHIMANO anti-lock braking system

* Please note that our ABS products are currently only available in the following countries: Belgium, Denmark, Estonia, Finland, France, Iceland, Italy, Latvia, Lithuania, Luxembourg, Malta, The Netherlands, Norway, Poland, Spain, Sweden

ABS SHIMANO + Blubrake



BS-AU301
ABS main unit for second-generation battery management system



BS-AS300-0
ABS main unit fixing parts (w/ internal mount adaptor)



BS-AS300-I
ABS main unit fixing parts

ABS main unit

v=Yes

Model no.		BS-AU301
Color		Black
Compatible brake type		Disc brake
Frame mount	Internal	√
	External	√
Adaptive bike category	E-MTB	√ **
	E-Road/Gravel	-
	E-Trekking/City	√
	E-Cargo	√
	E-Small tire	√
Compatible drive unit	SHIMANO	√ *
	Others	√
Compatible battery	SHIMANO	√ *
	3rd party	√
Compatible wheel size (mm)		1300-3000
Control tire	Front	√
	Rear	-
J-kit		√
Brake hose length		3,000 mm or less
Communication	E-TUBE	-
	CAN	√
	USB	-
Port for wheel speed sensor		√
Port for ABS indicator lamp/ CAN connection		√
Master unit		-
Firmware update	By E-TUBE PROJECT	-
	By Blubrake software	√
SD300 port (pcs)		0
SD300 connector (pcs)		0
SD50 port (pcs)		0
SD50 connector (pcs)		0
Average weight (g)		-
Note		*Refer to Line-up chart **With condition

ABS main unit fixing parts

v=Yes

Model no.		BS-AS300-0	BS-AS300-I
Color		Black	Black
Compatible brake type		-	-
Frame mount	Internal	-	√
	External	√	-
Average weight (g)		-	-
Note			



BS-AP301
ABS power cable (2nd-Gen battery management system)

ABS power cable

v=Yes

Model no.		BS-AP301
Color		Standard
Adaptation voltage (V)		24 - 60
Compatible drive unit	SHIMANO	√ *
	Others	-
Compatible battery	SHIMANO	√ *
	3rd party	√
Wire harness length (mm)		970
Communication	E-TUBE	-
	UART	√
	CAN	-
	USB	-
Average weight (g)		-
Note		*Refer to Line-up chart



BS-SS300-C
ABS speed sensor kit
(CENTER LOCK)



BS-SS300-S
ABS speed sensor kit
(6-bolt disc brake rotor)



SM-PCEBS
ABS system PC linkage device

ABS speed sensor kit

√=Yes

Model no.		BS-SS300-C	BS-SS300-S
Color		Black	Black
Compatible brake type		Disc brake	Disc brake
Mount type		F160PM/F180PM	F160PM/F180PM
Compatible rotor size	140	-	-
	160	-	-
	180	√	√
	203	√	√
	220	-	-
Compatible rotor mount	CENTER LOCK	√	-
	6-bolt	-	√
Compatible brake mount	International standard	-	-
	Post mount	√	√
	Post mount 180 direct	√	√
	Post mount 203 direct	-	-
	Flat mount front	-	-
	Flat mount rear	-	-
Wire harness length (mm)		140	140
Average weight (g)		-	-
Note			

ABS system PC linkage device

Model no.	SM-PCEBS
USB port (pcs)	Micro-B: 1
SD50 port (pcs)	0
SD300 port (pcs)	0
SD50 connector (pcs)	0
SD300 connector (pcs)	0
PC link port (pcs)	0
LED	1
Note	

Disc brake rotor



RT-EM910
CENTER LOCK Disc Brake Rotor for E-bike Speed Sensor System (203 mm)



RT-EM810
CENTER LOCK Disc Brake Rotor for E-bike Speed Sensor System (203 mm)



RT-EM600
CENTER LOCK Disc Brake Rotor for E-bike Speed Sensor System (180 mm)



RT-EM300
CENTER LOCK Disc Brake Rotor for E-bike Speed Sensor System (203 mm)



v=Yes

Model no.				RT-EM910	RT-EM810	RT-EM600	RT-EM300
Disc brake rotor type				Narrow type	Narrow type	Narrow type	Wide type
Function				√	√	-	-
				√	√	-	-
Disc brake rotor size	203 mm	Lock ring serration type	External	IRTEM910LE	IRTEM810LE	ERTEM600LEC	ERTEM300L
			Internal	IRTEM910LI	IRTEM810LI	ERTEM600LI3C	
	180 mm	Lock ring serration type	External	IRTEM910ME	IRTEM810ME	ERTEM600MEC	ERTEM300M
			Internal	IRTEM910MI	IRTEM810MI	ERTEM600MI3C	
	160 mm	Lock ring serration type	External	IRTEM910SE	IRTEM810SE	ERTEM600SEC	ERTEM300S
			Internal	IRTEM910SI	IRTEM810SI	ERTEM600SI3C	
	140 mm	Lock ring serration type	External	-	-	-	-
			Internal	-	-	-	
Disc brake rotor material				Stainless steel + aluminum + stainless steel	Stainless steel + aluminum + stainless steel	Stainless steel	Stainless steel
Pad compatibility	Metal			√	√	√	-
	Resin			√	√	√	√
Alloy lock ring				√	√	-	-
Note							

Speed sensor unit

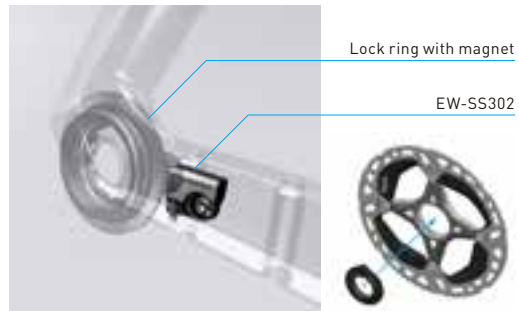

EW-SS302

Disc Brake Speed Sensor (SD300 type)

- Supports frame design flexibility and compatibility
 - » Compact design
 - » Flat mount disc brake specification
- Rotor with magnet lock ring set is available
- Compatible with DU-EP800



EW-SS300
Chainstay Speed Sensor
(SD300 type)



SM-DUE10
Chainstay Speed Sensor
(SD50 type)



EW-SS301
Disc Brake Speed Sensor
(SD300 type)



SM-DUE11
Disc Brake Speed Sensor
(SD50 type)

√=Yes

Series	SHIMANO	SHIMANO	SHIMANO	SHIMANO	SHIMANO
Model no.	EW-SS302	EW-SS301	EW-SS300	SM-DUE11	SM-DUE10
Brake spec	Disc	√	√	√	√
	Rim	-	-	√	√
Color	Black	Black	Black	Black	Black
Compatible drive unit	EP8/EP6	EP8/EP6	EP8/EP6	E8000/E7000 E6100/E6110 E5000	E8000/E7000 E6100/E6110 E5000
Cable length(mm)	340	-	-	√	√
	540	-	-	√	√
	760	√	√	√	√
	1400	√	√	√	√
Note	w/o magnet set	w/o magnet set	Spoke magnet set included	w/o magnet set	Spoke magnet set included

Chain



HG
SIL-TEC

CN-M9100
12-Speed MTB Chain



CN-E8000-11
11-Speed Super Narrow E-bike Chain



HG-X11
SIL-TEC

CN-HG701-11
11-Speed Super Narrow Chain



HG-X11
SIL-TEC

CN-HG601-11
11-Speed Super Narrow Chain



LINKGLIDE

CN-LG500
LINKGLIDE Chain (10/11-speed)



HG-X
SIL-TEC

CN-E6090-10
10-Speed E-bike Chain



HG
HYPERGLIDE

CN-E6070-9
9-Speed E-bike Chain



HG
HYPERGLIDE

CN-HG71
8-Speed MTB Chain

Chain

v=Yes

Model no.	CN-M9100	CN-E8000-11	CN-HG701-11	CN-HG601-11
Speed	12-speed	11-speed		
Type	HYPERGLIDE+	HG-X11	HG-X11	HG-X11
Outer link plate surface treatment	SIL-TEC	SIL-TEC	SIL-TEC	Gray
Inner link plate surface treatment	Chromizing	Chromizing	SIL-TEC	SIL-TEC
Directional design	√	√	√	√
Chromizing treatment link pin	√	√	√	√
Hollow pin	√	-	-	-
Connecting pin	QUICK-LINK (SM-CN910-12)	QUICK-LINK (SM-CN900-11)	QUICK-LINK (SM-CN900-11)	QUICK-LINK (SM-CN900-11)
Weight (114 link)	242 g	257 g	257 g	257 g
Code no.	ICNM9100116Q ICNM9100126Q ICNM9100138Q	ICNE800011116Q ICNE800011126Q ICNE800011138Q	ICNHG70111126Q ICNHG70111138Q	ICNHG60111126Q ICNHG60111138Q
Replacement/remark	116 links 126 links 138 links	116 links 126 links 138 links	126 links 138 links	126 links 138 links

v=Yes

Model no.	CN-LG500	CN-E6090-10	CN-E6070-9	CN-HG71
Speed	10/11-speed	10-speed	9-speed	8-speed
Type	LINKGLIDE	HG-X	HG <small>HYPERGLIDE</small>	HG <small>HYPERGLIDE</small>
Outer link plate surface treatment	Gray	SIL-TEC	Gray	Silver
Inner link plate surface treatment	Gray	SIL-TEC	Gray	Gray
Directional design	√	√	-	-
Chromizing treatment link pin	√	√	√	√
Hollow pin	-	-	-	-
Connecting pin	QUICK-LINK (SM-CN900-11)	Two lines	Silver color	Black color
Weight (114 link)	257 g	276 g	276 g	324 g
Code no.	ICNLG500116Q ICNLG500126Q ICNLG500138Q	ICNE609010118I ICNE609010126I ICNE609010138I	ICNE60709118I ICNE60709126I ICNE60709138I	ECNHG71C116I ECNHG71C138I
Replacement/remark	118 links 126 links 138 links	Front single only 118 links 126 links 138 links	Front single only 118 links 126 links 138 links	CN-HG91 CN-HG70

Recommended hydraulic disc brake system

XTR



I-SPECEV

BL-M9100
Hydraulic Disc Brake Lever
I-SPEC EV Clamp Band



I-SPECEV

SERVO WAVE
ACTION

BL-M9120
Hydraulic Disc Brake Trail Lever
I-SPEC EV Clamp Band



ONE WAY BLEEDING

BR-M9100
Hydraulic Disc Brake
2-Piston Caliper



ICE
TECHNOLOGIES
Four
Piston

BR-M9120
Hydraulic Disc Brake
4-Piston Caliper

√=Yes

Brand		<i>XTR</i>	<i>XTR</i>	<i>SHIMANO DEGRE XT</i>	<i>SHIMANO DEGRE XT</i>
Model no.		BL-M9100/BR-M9100	BL-M9120/BR-M9120	BL-M8100/BR-M8100	BL-M8100/BR-M8110
Disc brake caliper related	High brake power SERVO WAVE	-	√	√	√
	Piston type	2-piston	4-piston	2-piston	2-piston
	Braking power %	126%	146%	134%	134%
	Brake pad	Fin or not	w/o fin	w/o fin	w/o fin, w/ fin
Material		Resin/metal	Resin/metal	Resin/metal	Resin/metal
Brake lever related	Material	CFRP	Aluminum	Aluminum	Aluminum
	Finger	2-finger	2-finger	2-finger	2-finger
	Technology	<i>I-SPECEV</i>	<i>I-SPECEV</i>	<i>I-SPECEV</i>	<i>I-SPECEV</i>
Oil bleeding	ONE WAY BLEEDING	√	-	√	√
	Funnel bleeding tool	√	√	√	√

SHIMANO
DEORE XT



I-SPEC EV
SERVO WAVE Reach Free
ACTION Adjust Stroke

BL-M8100
Hydraulic Disc Brake Lever
I-SPEC EV Clamp Band

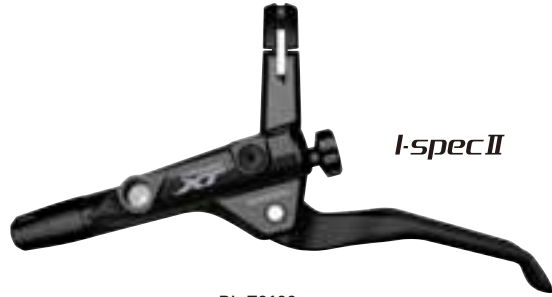

I-spec II

BL-T8100
3-finger Hydraulic Disc Brake Lever



ICE
TECHNOLOGIES
ONE WAY BLEEDING

BR-M8100
Hydraulic Disc Brake
2-Piston Caliper



ONE WAY BLEEDING

BR-M8110
Flat Mount Disc Brake
Caliper



ICE
TECHNOLOGIES
Four
Piston

BR-M8120
Hydraulic Disc Brake
4-Piston Caliper

V=Yes

Brand				
Model no.		BL-M8100/BR-M8120	BL-T8100/BR-M8100	BL-T8100/BR-M8120
Disc brake caliper related	High brake power SERVO WAVE	√	-	-
	Piston type	4-piston	2-piston	4-piston
	Braking power %	146%	112%	123%
	Brake pad	Fin or not	w/o fin, w/ fin	w/o fin, w/ fin
Material		Resin/metal	Resin/metal	Resin/metal
Brake lever related	Material	Aluminum	Aluminum	Aluminum
	Finger	2-finger	3-finger	3-finger
	Technology	I-SPEC EV	I-spec II	I-spec II
Oil bleeding		-	√	-
	Funnel bleeding tool	√	√	√

Recommended hydraulic disc brake system

SLX



BL-M7100
Hydraulic Disc Brake Lever
I-SPEC EV Clamp Band

SHIMANO DEORE



BL-M6100
Hydraulic Disc Brake Lever
I-SPEC EV



BR-M7100
Hydraulic Disc Brake
2-Piston Caliper



BR-M7120
Hydraulic Disc Brake
4-Piston Caliper



BR-M6100
Hydraulic Disc Brake
Caliper 2-Piston



BR-M6120
Hydraulic Disc Brake
Caliper 4-Piston

√=Yes

Brand		SLX	SLX	SHIMANO DEORE	SHIMANO DEORE
Model no.		BL-M7100/BR-M7100	BL-M7100/BR-M7120	BL-M6100/BR-M6100	BL-M6100/BR-M6120
Disc brake caliper related	High brake power SERVO WAVE	√	√	√	√
	Piston type	2-piston	4-piston	2-piston	4-piston
	Braking power %	134%	146%	122%	146%
	Brake pad	Fin or not	w/o fin, w/ fin	w/o fin, w/ fin	w/o fin, w/ fin
Material		Resin/metal	Resin/metal	Resin/metal	Resin/metal
Brake lever related	Material	Aluminum	Aluminum	Aluminum	Aluminum
	Finger	2-finger	2-finger	2-finger	2-finger
	Technology	I-SPEC EV	I-SPEC EV	I-SPEC EV	I-SPEC EV
Oil bleeding	 ONE WAY BLEEDING	√	-	√	√
	Funnel bleeding tool	√	√	√	√

SHIMANO
CUES**I-spec II**Reach
Adjust

BL-U8000 **NEW**
SHIMANO CUES Hydraulic Disc Brake Lever
I-SPEC II Clamp Band



BL-MT501
Hydraulic Disc Brake Lever
I-SPEC II Clamp Band



BR-U8000 **NEW**
SHIMANO CUES Hydraulic Disc Brake
2-Piston Caliper



BR-U8020 **NEW**
SHIMANO CUES Hydraulic Disc Brake
4-Piston Caliper











BR-MT520
Hydraulic Disc Brake
4-Piston MTB Caliper

		NEW	NEW	V=Yes
Brand		SHIMANO CUES	SHIMANO CUES	SHIMANO
Model no.		BL-U8000/BR-U8000	BL-U8000/BR-U8020	BL-MT501/BR-MT520
Disc brake caliper related	High brake power SERVO WAVE	-	-	√
	Piston type	2-piston	4-piston	4-piston
	Braking power %	112%	123%	146%
	Brake pad	Fin or not	w/o fin, w/ fin	w/o fin, w/ fin
Material		Resin/metal	Resin/metal	Resin/metal
Brake lever related	Material	Aluminum	Aluminum	Aluminum
	Finger	3-finger	3-finger	2-finger
	Technology	I-spec II	I-spec II	I-spec II
Oil bleeding	ONE WAY BLEEDING	√	-	√
	Funnel bleeding tool	√	√	√

Disc brake rotor

E-BIKE DESIGN Rotors with built-in magnets for speed sensors (rear only)
A built-in magnet is used on rotors when the speed sensor is located near the rear dropout.

	Mount	Model no.	Performance indicator	Technology	E-Bike	Compatible brake pad		Disc brake rotor size	Lock ring Alloy	Lock ring spline type					
						Metal	Resin			External	Internal				
	CENTER LOCK	RT-CL900				X	X	NEW 203 mm	X	-	IRTCL900LJ				
						X	X	NEW 180 mm	X	-	IRTCL900MJ				
						X	X	160 mm	X	-	IRTCL900SJ				
		RT-CL800				X	X	NEW 203 mm	X	-	IRTCL800LJ				
						X	X	NEW 180 mm	X	-	IRTCL800MJ				
						X	X	160 mm	X	-	IRTCL800SJ				
		RT-EM910								X	X	203 mm	X	IRTEM910LE	IRTEM910LI
										X	X	180 mm	X	IRTEM910ME	IRTEM910MI
										X	X	160 mm	X	IRTEM910SE	IRTEM910SI
		RT-EM810								X	X	203 mm	X	IRTEM810LE	IRTEM810LI
	X		X	180 mm	X					IRTEM810ME	IRTEM810MI				
	X		X	160 mm	X					IRTEM810SE	IRTEM810SI				
	RT-EM600			Standard						X	X	203 mm	-	ERTEM600LEC	Black: ERTEM600LI3C Silver: ERTEM600LIC
										X	X	180 mm	-	ERTEM600MEC	Black: ERTEM600MI3C Silver: ERTEM600MIC
										X	X	160 mm	-	ERTEM600SEC	Black: ERTEM600SI3C Silver: ERTEM600SIC
	RT-EM300									-	X	203 mm	-	ERTEM300L	ERTEM300L
						-	X	180 mm	-	ERTEM300M	ERTEM300M				
						-	X	160 mm	-	ERTEM300S	ERTEM300S				

Chainring

	Recommended FC	Model no.	GEAR	Chain Guard	Color	S-PART no. (Chainring/4 arm adapter/ Fixing Bolt & Nut/ Chain Guard [With CG model])	Y-PART no. (Chainring ONLY)	
	FC-E5000/ E5010	SM-CRE50	38T	With double		ESMCRE50A8DG	Y0J338000	
				With single		ESMCRE50A8SG		
				Without		ESMCRE50A8X		
			44T	With double		ESMCRE50B4DG	Y0J344000	
				With single		ESMCRE50B4SG		
				Without		ESMCRE50B4X		
	FC-E6100/E8000/ E8050/M8150/ EM600/EM900	SM-CRE61	38T	With double		ESMCRE61A8DG	Y0J138000	
				With single		ESMCRE61A8SG		
				Without	Black	ESMCRE61A8XL		
			44T	Without	Silver	ESMCRE61A8XS	Y0J144000	
				With double		ESMCRE61B4DG		
				With single		ESMCRE61B4SG		
Without		ESMCRE61B4X						
		CR-EM800	32T	Without		ICREM800A2XL	Y0RU9802T	
		CR-ET600	38T	With double		ECRET600A8DG	Y0PX9801T	
	With single				ECRET600A8SG			
	Without			Black	ECRET600A8XL			
	44T		Without	Silver	ECRET600A8XS	Y0PX9802T		
			With double		ECRET600B4DG			
			With single		ECRET600B4SG			
Without		ECRET600B4X						
		SM-CRE70-B	34T (53 mm chain line)	Without		ESMCRE70BA4X	Y0J434000	
			34T (55 mm chain line)			ESMCRE70B55A4XL		
		SM-CRE70	38T	With double		ESMCRE70A8DGL	Y0J438000	
				Without		ESMCRE70A8XL		
		SM-CRE70-12-B	36T (53 mm chain line)	Without		ESMCRE7012BA6XL	Y0KK36000	
			36T (55 mm chain line)			ESMCRE7012B55A6XL		
		SM-CRE70-12	42T	With double		ESMCRE7012B2DGL	Y0KK42000	
		SM-CRE80	34T	Without		ISMCRE80A4X	Y1VY00030	
			38T			ISMCRE80A8X	Y1VY00040	
			44T	With double		ISMCRE80B4DG	Y1VY44000	
			SM-CRE80-B	34T (53 mm chain line)	Without		ISMCRE80BA4X	Y1VY00030
				34T (55 mm chain line)			ISMCRE80B55A4XL	
				38T (53 mm chain line)			ISMCRE80BA8X	Y1VY00040
		38T (55 mm chain line)				ISMCRE80B55A8XL		
		SM-CRE80-R	47T	Without		ISMCRE80RB7XL	Y0JZ47000	
		SM-CRE80-12-B	34T (53 mm chain line)	Without		ISMCRE8012BA4X	Y0KJ34100	
			34T (55 mm chain line)			ISMCRE8012B55A4XL		
			36T (53 mm chain line)			ISMCRE8012BA6X	Y0KJ36100	
			36T (55 mm chain line)			ISMCRE8012B55A6XL		
			38T (53 mm chain line)			ISMCRE8012BA8X	Y0KJ38100	
			38T (55 mm chain line)			ISMCRE8012B55A8XL		
		SM-CRE80-12-SB	34T	Without		ISMCRE8012SBA4XL	Y0KJ34100	
			36T			ISMCRE8012SBA6XL	Y0KJ36100	

Chain



Chromizing Treatment Link Pin



Hollow Pin



For Front Single Speed
E-bike designed chains are developed for drivetrains without a front derailleur.



For both e-bikes and non-e-bikes
High wear-resistance maintains shifting performance on bikes with or without a drive unit.

12-speed

Type	Photo	Model no.	Performance indicator	E-Bike	Outer link plate surface treatment	Inner link plate surface treatment			Connecting pin	Weight (114 link)	Code no.
HYPERGLIDE+		CN-M8100			Gray	Chromizing	X	-	QUICK-LINK (SM-CN910-12)	252 g	ICNM8100116Q ICNM8100126Q ICNM8100138Q

11-speed HG & 11/10-speed LG

Type	Photo	Model no.	Performance indicator	E-Bike	Outer link plate surface treatment	Inner link plate surface treatment			Connecting pin	Weight (114 link)	Code no.
HG-X11		CN-HG701-11			SIL-TEC	SIL-TEC	X	-	QUICK-LINK (SM-CN900-11)	257 g	ICNHG70111116Q ICNHG70111126Q ICNHG70111138Q
		CN-HG601-11			Gray	SIL-TEC	X	-	QUICK-LINK (SM-CN900-11)	257 g	ICNHG60111116Q ICNHG60111126Q ICNHG60111138Q
LG		CN-LG500			Gray	Gray	X	-	QUICK-LINK (SM-CN900-11)	257 g	ICNLG500116Q ICNLG500126Q ICNLG500138Q

11-speed

Type	Photo	Model no.	Performance indicator	E-Bike	Outer link plate surface treatment	Inner link plate surface treatment			Connecting pin	Weight (114 link)	Code no.
HG-X11		CN-E8000-11			SIL-TEC	Chromizing	X	-	QUICK-LINK (SM-CN900-11)	257 g	ICNE800011116Q ICNE800011126Q ICNE800011138Q

10-speed

Type	Photo	Model no.	Performance indicator	E-Bike	Outer link plate surface treatment	Inner link plate surface treatment			Connecting pin	Weight (114 link)	Code no.
HG-X		CN-E6090-10			SIL-TEC	SIL-TEC	X	-	Two Lines	276 g	ICNE609010118I ICNE609010126I ICNE609010138I



9-speed

Type	Photo	Model no.	Performance indicator	E-Bike	Outer link plate surface treatment	Inner link plate surface treatment			Connecting pin	Weight (114 link)	Code no.
HG		CN-E6070-9			Gray	Gray	X	-	Silver color	276 g	ICNE60709118I ICNE60709126I ICNE60709138I

8/7/6-speed

Type	Photo	Model no.	Performance indicator	Outer link plate surface treatment	Inner link plate surface treatment			Connecting pin	Weight (114 link)	Code no.
HG/UG		CN-HG71		Gray	Gray	X	-	QUICK-LINK (CN-UG51)	324 g	ECNHG71C116Q
		CN-HG71		Gray	Gray	X	-	Black color	324 g	ECNHG71C116I ECNHG71C138I

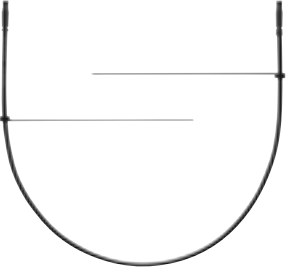
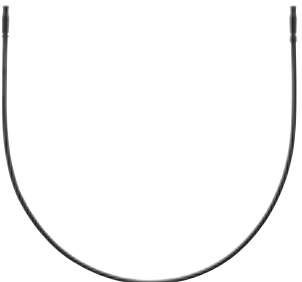
Electric wire

	Model no.	Series	Description	Length	Code no.
	EW-SD300-I	SHIMANO	2nd generation E-TUBE cable for Di2 (for built-in routing)	150 mm	IEWSD300IL015
				200 mm	IEWSD300IL020
				250 mm	IEWSD300IL025
				300 mm	IEWSD300IL030
				350 mm	IEWSD300IL035
				400 mm	IEWSD300IL040
				500 mm	IEWSD300IL050
				550 mm	IEWSD300IL055
				600 mm	IEWSD300IL060
				650 mm	IEWSD300IL065
				700 mm	IEWSD300IL070
				750 mm	IEWSD300IL075
				800 mm	IEWSD300IL080
				850 mm	IEWSD300IL085
				900 mm	IEWSD300IL090
					EW-SD300
200 mm	IEWSD300L020				
250 mm	IEWSD300L025				
300 mm	IEWSD300L030				
350 mm	IEWSD300L035				
400 mm	IEWSD300L040				
500 mm	IEWSD300L050				
550 mm	IEWSD300L055				
600 mm	IEWSD300L060				
650 mm	IEWSD300L065				
700 mm	IEWSD300L070				
750 mm	IEWSD300L075				
800 mm	IEWSD300L080				
850 mm	IEWSD300L085				
900 mm	IEWSD300L090				
	EW-SD50	SHIMANO	1st generation E-TUBE cable for Di2 (for external routing)		
				200 mm	IEWSD50L20
				250 mm	IEWSD50L25
				300 mm	IEWSD50L30
				350 mm	IEWSD50L35
				400 mm	IEWSD50L40
				500 mm	IEWSD50L50
				550 mm	IEWSD50L55
				600 mm	IEWSD50L60
				650 mm	IEWSD50L65
				700 mm	IEWSD50L70
				750 mm	IEWSD50L75
				800 mm	IEWSD50L80
				850 mm	IEWSD50L85
				900 mm	IEWSD50L90
				950 mm	IEWSD50L95
1,000 mm	IEWSD50L100				
1,200 mm	IEWSD50L120				
1,400 mm	IEWSD50L140				
1,600 mm	IEWSD50L160				



Wire holder

	Model no.	Description	Code no.	EP8/EP6	E8000	E7000	E6100	E5000
	Cable tie	Wire holder: Cable tie for internal routing	IEWSD50ISM1	-	✓	✓	✓	✓

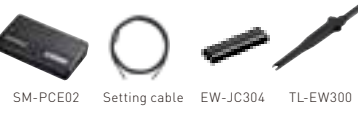
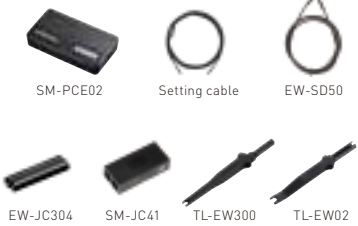















E-TUBE kit

	Model no.	Usage	Description	Code no.
 SM-PCE02 EW-SD50 SM-JC41 TL-EW02	SM-PCE02 (SD50 type)	For connecting the bicycle (system or components) to a PC via a PC linkage device	PC link device for SD50	IETUBEKIT3EB (English) IETUBEKIT3GB (German)
	EW-SD50		Electric wire for SD50	
	SM-JC41		Junction for SD50	
	TL-EW02		Plug tool for SD50	
 SM-PCE02 Setting cable EW-JC304 TL-EW300	SM-PCE02 (SD300 type)	For connecting the bicycle (system or components) to a PC via a PC linkage device	PC link device for SD300	IETUBEKIT5EB (English) IETUBEKIT5GB (German)
	Setting cable (SD300 type)		Electric wire for SD300	
	EW-JC304		Junction for SD300	
	TL-EW300		Plug tool for SD300	
 SM-PCE02 Setting cable EW-SD50 EW-JC304 SM-JC41 TL-EW300 TL-EW02	SM-PCE02 (SD300/50 type)	For connecting the bicycle (system or components) to a PC via a PC linkage device	PC link device for SD300/50	IETUBEKIT4EB (English) IETUBEKIT4GB (German)
	Setting cable (SD300 type)		Electric wire for SD300	
	EW-SD50		Electric wire for SD50	
	EW-JC304		Junction for SD300	
	SM-JC41		Junction for SD50	
	TL-EW300		Plug tool for SD300	
	TL-EW02		Plug tool for SD50	

Conversion adapter and wire junctions

	Model no.	Series	Compatible with	Description	Code no.
	EW-AD305	SHIMANO	EW-SD300	• Conversion adapter for EW-SD50 and EW-SD300	IEWAD305
	EW-JC302			• 2-port junction for EW-SD300	IEWJC302
	EW-JC304			• 4-port junction for EW-SD300	IEWJC304

Accessories

	Model no.	Series	Compatible with	Description	Code no.
	EW-CL300-S	SHIMANO	EW-SD300	Cord clip for EW-SD300 and SP outer cable/ brake hose: ø 4	Y7HS10000
	EW-CL300-M			Cord clip for EW-SD300 and SP outer cable/ brake hose: ø 5	Y7HS20000
	EW-CB300-S			Cord band for EW-SD300 and ø 22.2 handlebar	Y7HX01000
	EW-CB300-M			Cord band for EW-SD300 and ø 31.8 handlebar	Y7HX02000
	EW-CB300-L			Cord band for EW-SD300 and ø 35 handlebar	Y7HX03000
	EW-CC300			Cord fixing tape for EW-SD300: Black	IEWCC300LA
				Cord fixing tape for EW-SD300: White	IEWCC300WA
	SM-EWC2			EW-SD50	Wire Covers: Black
			EW-SD50	Wire Covers: White	ISMEWC2W
	EW-GM300-S		EW-SD300	Frame grommet for EW-SD300 (6 mm CIRCLE)	Y7HN01000
	EW-GM300-M			Frame grommet for EW-SD300 (7 x 8 mm)	Y7HN02000
	SM-GM01		EW-SD50	Frame Grommets: (6 mm CIRCLE) X 4	ISMGM01
	SM-GM02			Frame Grommets: (7 X 8 mm) X 4	ISMGM02
	SM-PCE02		EW-SD50 (compatible with EW-SD300 with EW-AD305)	PC Linkage Device	ISMPCE02B (SD50 type) ISMPCE02B2 (SD300 type) ISMPCE02B3 (SD50/SD300 type)
	Setting cable	EW-SD300	SM-PCE02 PC setting cable (SD300 type) 2,050 mm	Y79M9802T	
	TL-EW300	EW-SD300	Plug tool: Connection and disconnection of EW-SD300	Y7HE40000	
	TL-EW02	EW-SD50	Plug tool: Connection and disconnection of E-TUBE electric wires	Y6VE16000	

Tool



TL-FC32

HOLLOWTECH II bottom bracket cup tool



Usage	For installation and removal of HOLLOWTECH II/2-PIECE CRANKSET bottom bracket cup tool
USP	Hardened steel for rigidity and durability
Code no.	Y13009210



TL-FC36

HOLLOWTECH II bottom bracket cup tool



Usage	<ul style="list-style-type: none"> • For installation and removal of HOLLOWTECH II/2-PIECE CRANKSET bottom bracket cup tool • For installation and removal of disc brake rotor lock ring for 20 mm axle/15 mm E-THRU axle hub
USP	<ul style="list-style-type: none"> • Offset design allows turning the tool without touching the chain stay • Precision laser cut profile for a secure fit • Chrome plated chromoly body for durability and rigidity • Ergonomic handle
Code no.	Y13098000



TL-FC33

HOLLOWTECH II bottom bracket cup tool



Usage	For installation and removal of HOLLOWTECH II/2-PIECE CRANKSET bottom bracket cup tool
USP	<ul style="list-style-type: none"> • Impact wrench version HOLLOWTECH II/2-PIECE CRANKSET bottom bracket tool • Precise spline profile • Hardened steel for rigidity and durability
Code no.	Y13009230



TL-FC39

Lock ring tool for DU-EP800/E8000/E7000/E6100/E5000

Usage	Installation and removal tool of lock ring for chainring
USP	<ul style="list-style-type: none"> • Adapter style to use with TL-FC36 or TL-FC32 • Precise spline profile • Hardened steel for rigidity and durability
Compatibility	DU-EP800/E8000/E7000/E6100/E5000
Remark	An impact wrench cannot be used
Code no.	YEZY00016



TL-CN10

QUICK-LINK connecting & removing pliers

Usage	Connecting and removing SHIMANO QUICK-LINK
USP	<ul style="list-style-type: none"> • 2-in-1 operation pliers that allow SHIMANO QUICK-LINK to be installed and removed manually • Simple and easy to use • Ergonomic and comfortable handles offer excellent grip • Wire latch holds handles together when not in use • Great to use at home and in the workshop
Code no.	Y13022000



TL-CN28

6-11-speed compatible chain tool



Usage	For cutting and connecting SHIMANO 6-11-speed chain (HG-EV/HG-X/HG/IG/UG chain) & 1/2" x 1/8" (CN-NX10)
USP	<ul style="list-style-type: none"> • Home mechanic chain tool • Ergonomic handle and grip • SHIMANO special driving pin retains the excess ring of the removed 10/11-speed rivet pin for smooth operation • Ball bearing between the driving pin and the axle enables handle rotation with less effort • Molybdenum treatment on the thread of the axle for smoother rotation • With connecting pin guide remover
Code no.	Y13098500



Spare arrow

Code no. Y13098190





TL-CN29

9-12-speed compatible chain tool



Usage	For cutting and connecting SHIMANO 9-12-speed chain
USP	<ul style="list-style-type: none"> • Home mechanic chain tool • Ergonomic handle and grip • SHIMANO special driving pin retains the excess ring of the removed rivet pin for smooth operation • Ball bearing between the driving pin and the axle enables handle rotation with less effort • Molybdenum treatment on the thread of the axle for smoother rotation • With connecting pin guide remover
Compatibility	SHIMANO 9-12-speed chain
Remark	Home mechanic chain tool
Code no.	Y13098700



Spare arrow

Code no. Y13098190



TL-EW300

Plug tool for connection and disconnection of Electric wire

Usage	Plug tool for connection and disconnection of EW-SD300
Compatibility	EW-SD300
Code no.	Y7HE40000



TL-EW02

Plug tool for connection and disconnection of Electric wire

Usage	Plug tool for connection and disconnection of EW-SD50
Compatibility	EW-SD50
Code no.	Y6VE16000



TL-DUE60

Chain tension measurement tool

Usage	Chain tension measurement tool for SHIMANO STEPS internal geared hub models
USP	Can be measured and adjusted the chain tension from either the top or bottom of the chain
Code no.	YEZY00002



TL-BME02

Measurement tool for the installation of battery mounts

Usage	Measurement tool for installation of BM-EN600/BM-E8010/BM-E8016
Compatibility	BM-EN600/BM-E8010/BM-E8016
Code no.	YEZY00014

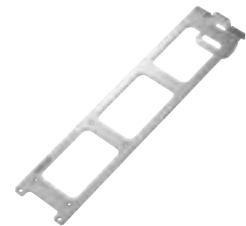

TL-BME03

Measurement tool for the installation of battery mounts

Usage	Measurement tool for installation of BM-E8020
Compatibility	BM-E8020
Code no.	YEZY00015



TL-FC430

Lock ring tool for DU-EP801/EP600

Usage	Installation and removal tool of lock ring for chainring
USP	<ul style="list-style-type: none"> • Adapter style to use with TL-FC36, TL-FC33 or TL-FC32 • Precise spline profile • Hardened steel for rigidity and durability
Compatibility	DU-EP801/EP600
Remark	An impact wrench cannot be used
Code no.	Y70898030



TL-BME04

Measurement tool for the installation of battery mounts

Usage	Measurement tool for installation of BM-EN801/BM-EN800/BM-E8030/BM-E8031 Position adjustment tool for installation of key cylinder
Compatibility	BM-EN801/BM-EN800/BM-E8030/BM-E8031
Code no.	Y13000050





TL-BME05

Measurement tool for the installation of battery mounts

Usage	Measurement tool for installation of BM-EN801/BM-EN800/BM-E8030/BM-E8031 Position adjustment tool for 630 Wh battery case and installation of key cylinder
Compatibility	BM-EN801/BM-EN800/BM-E8030/BM-E8031
Code no.	Y13000070

NEW Internal assembly of internal geared hub

	Speed	Series	Model no.	Axle length (mm)				
				182	184	187	193	Others
 SG-C7000-5D	3-speed	3CC	SG-3C-41	-	-	-	-	Y35U98010 (168) Y33R98020 (175) Y35U98020 (178)
			SG-3C41-DX	-	-	-	-	Y35U98010 (168) Y33R98020 (175)
 SG-C3001-7D	5-speed	5C	SG-C7000-5C	-	-	Y3FH98010	-	-
			SG-C7050-5C	-	-	Y3FE98010	-	-
	5CD	SG-C7002-5CD	-	-	Y3J098010	-	-	
		5D	SG-C7000-5D	-	-	Y3FJ98010	-	-
	SG-C7050-5D		-	-	Y3FF98010	-	-	
	5R/5V	SG-C7000-5R SG-C7000-5V	-	-	Y3FG98010	-	-	
SG-C7050-5R SG-C7050-5V		-	-	Y3FD98010	-	-		
7-speed	7C	SG-C3001-7C	-	-	-	-	Y3EV98150 (176)	
		SG-C3001-7C-DX	-	Y3EV98020	-	-	Y3EV98010 (176)	
	7D	SG-C3001-7D	-	-	Y3EW98010	-	-	
	7R	SG-C3001-7R	Y3ET98010	-	-	-	Y3ET98020 (201)	
8-speed	8C	SG-C6001-8C	-	Y3EJ98010	-	-	-	
	8CD	SG-C6001-8CD	-	-	Y3EL98010	-	-	
	8D	SG-C6001-8D	-	-	Y3EK98010	-	-	
		SG-C6061-8D	-	-	Y3EE98030	-	-	
	8R/8V	SG-C6001-8R SG-C6001-8V	-	Y3EH98010	-	-	Y3EH98020 (203)	
		SG-C6011-8R SG-C6011-8V	-	Y3EG98010	-	-	-	
11-speed	ALFINE-11	SG-S7001-11	-	-	Y3EN98010	-	-	
		SG-S7051-11	-	-	Y3EM98010	-	-	
8-speed	ALFINE-8	SG-S7001-8	-	-	Y3EB98010	-	-	
		SG-S7051-8	-	-	Y3EA98010	-	-	
 SG-C6001-8D								

Service & Warranty

ALWAYS THERE

As sure as wheels turn, bikes need fine-tuning from time to time. The more fun you have, the more parts like your chain and brake pads will wear out. But replace them promptly and your bike will serve you well and give you pleasure for many years to come. That's why it's reassuring to know that a Shimano dealer is never far away. Whether you're e-biking through your hometown or hitting the hills or mountains somewhere in Europe, support is always around the corner.

- Shimano Quality Standard
- 2-year warranty on all components – including battery
- Dedicated user-friendly software platform for e-bike set-up
- Fast, high-quality service – anywhere in the world

FAQ

SHIMANO STEPS FAQ
<https://si.shimano.com/iFAQ/STP0A>

E-TUBE PROJECT Professional FAQ
<https://bike.shimano.com/e-tube/project/forwindows/faq.html>

E-TUBE PROJECT Cyclist FAQ
<https://bike.shimano.com/e-tube/project/formobile/faq.html>



SHIMANO STEPS e-bike and e-MTB systems
come equipped on a wide variety of bicycle brands.
Visit our website to explore your favourite brands – and
don't forget to check out the news section for events
where you can test ride these bikes.

SHIMANO
STEPS
shimano-steps.com

EBIKECATSH24EN



8 717009 636452