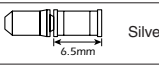
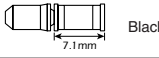

WARNING

"Maintenance interval depends on the usage and riding circumstances. Clean regularly the chain with an appropriate chain cleaner. Never use alkali based or acid based solvents such as rust cleaners. If those solvent be used chain might break and cause serious injury."

- Check that the wheels are fastened securely before riding the bicycle. If the wheels are loose in any way, they may come off the bicycle and serious injury may result.
- Use the reinforced connecting pin only for connecting the narrow type of chain.
- There are two different types of reinforced connecting pins available. Be sure to check the table below before selecting which pin to use. If connecting pins other than reinforced connecting pins are used, or if a reinforced connecting pin or tool which is not suitable for the type of chain is used, sufficient connection force may not be obtained, which could cause the chain to break or fall off.

Chain	Reinforced connecting pin	Chain tool
9-speed super narrow chain such as CN-7701 / CN-HG93	 Silver	TL-CN32 / TL-CN27
8- / 7- / 6-speed narrow chain such as CN-HG50 / CN-HG40	 Black	TL-CN32 / TL-CN27

- If it is necessary to adjust the length of the chain due to a change in the number of sprocket teeth, make the cut at some other place than the place where the chain has been joined using a reinforced connecting pin or an end pin. The chain will be damaged if it is cut at a place where it has been joined with a reinforced connecting pin or an end pin.
- Check that the tension of the chain is correct and that the chain is not damaged. If the tension is too weak or the chain is damaged, the chain should be replaced. If this is not done, the chain may break and cause serious injury.
- Obtain and read the service instructions carefully prior to installing the parts. Loose, worn or damaged parts may cause the bicycle to fall over and serious injury may occur as a result. We strongly recommend only using genuine Shimano replacement parts.
- Obtain and read the service instructions carefully prior to installing the parts. If adjustments are not carried out correctly, the chain may come off and this may cause you to fall off the bicycle which could result in serious injury.
- Read these Technical Service Instructions carefully, and keep them in a safe place for later reference.

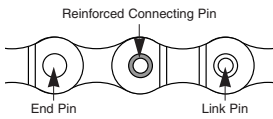

Note

- If gear shifting operations do not feel smooth, wash the derailleur and lubricate all moving parts.
- If the amount of looseness in the links is so great that adjustment is not possible, you should replace the derailleur.
- You should periodically clean the derailleur and lubricate all moving parts (mechanism and pulleys).
- If gear shifting adjustment cannot be carried out, check the degree of parallelism at the rear end of the bicycle. Also check if the cable is lubricated and if the outer casing is too long or too short.
- If you hear abnormal noise as a result of looseness in a pulley, you should replace the pulley.
- If the wheel becomes stiff and difficult to turn, you should lubricate it with grease.
- Do not apply any oil to the inside of the hub, otherwise the grease will come out.
- You should periodically wash the sprockets in a neutral detergent and then lubricate them again. In addition, cleaning the chain with neutral detergent and lubricating it can be an effective way of extending the useful life of the sprockets and the chain.
- If the chain keeps coming off the sprockets during use, replace the sprockets and the chain.
- Always be sure to use the sprocket set bearing the same group marks. Never use in combination with a sprocket bearing a different group mark.
- Use a frame with internal cable routing is strongly discouraged as it has tendencies to impair the SIS shifting function due to its high cable resistance.
- Use an outer casing which still has some length to spare even when the handlebars are turned all the way.
- Grease the inner cable and the inside of the outer casing before use to ensure that they slide properly.
- Operation of the levers related to gear shifting should be made only when the front chainwheel is turning.
- Parts are not guaranteed against natural wear or deterioration resulting from normal use.
- For maximum performance we highly recommend Shimano lubricants and maintenance products.
- For any questions regarding methods of installation, adjustment, maintenance or operation, please contact a professional bicycle dealer.

This service instruction explains how to use and maintain the Shimano bicycle parts which have been used on your new bicycle. For any questions regarding your bicycle or other matters which are not related to Shimano parts, please contact the place of purchase or the bicycle manufacturer.

SHIMANO

SHIMANO AMERICAN CORPORATION
One Holland, Irvine, California 92618, U.S.A. Phone: +1-949-951-5003

SHIMANO EUROPE B.V.
Industrieweg 24, 8071 CT Nunspeet, The Netherlands Phone: +31-341-272222

SHIMANO INC.
3-77 Oimatsu-cho, Sakai-shi, Osaka 590-8577, Japan

* Service Instructions in further languages are available at : <http://techdocs.shimano.com>

Please note: specifications are subject to change for improvement without notice. (English)
© May 2010 by Shimano Inc. XBC IZM Printed in Malaysia.

Rear Drive System

In order to realize the best performance, we recommend that the following combination be used.

Rapidfire Plus	ST-EF51-8R	ST-EF51-7R
Outer casing	SIS	
Rear derailleur	RD-M360 / RD-M310	
Type	RD-M360 (SGS) / RD-M310 (Smart Cage)	
Freehub	FH-RM30-8	FH-RM30-7
Gears	8	7
Cassette sprocket	CS-HG40-8I CS-HG30-8I	CS-HG30-I CS-HG20-7
Chain	CN-HG50 / CN-HG40	
Bottom bracket guide	SM-SP18 / SM-BT18	

Specifications

Model number	RD-M360 / RD-M310
Type	RD-M360 (SGS) / RD-M310 (Smart Cage)
Total capacity	43T
Largest sprocket	28T - 34T
Smallest sprocket	11T
Front chainwheel tooth difference	20T
Applicable front chainwheel (chaining tooth configuration)	FC-M311 (42-32-22T / 48-38-28T) FC-M171 / M131 (42-34-24T / 48-38-28T)

Cassette sprocket tooth combination

Model number	Sprockets	Group name	Tooth combination
CS-HG40-8I CS-HG30-8I	8	an	11, 13, 15, 17, 20, 23, 26, 30T
	8	aw	11, 13, 15, 18, 21, 24, 28, 32T
	8	ao	11, 13, 15, 17, 20, 23, 26, 34T
CS-HG30-I	7	ac	11, 13, 15, 18, 21, 24, 28T
CS-HG20-7	7	E / bm	12, 14, 16, 18, 21, 24, 28T

Gear shifting operation

Both lever (A) and lever (B) always return to the initial position when they are released after shifting. When operating one of the levers, always be sure to turn the crank arm at the same time.

To shift from a small sprocket to a larger sprocket (Lever A)

To shift one step only, press lever (A) to the (1) position. To shift two steps at one time, press to the (2) position.

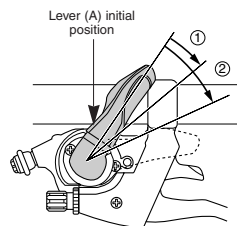

To shift from a large sprocket to a smaller sprocket (Lever B)

Press lever (B) once to shift one step from a larger to a smaller sprocket.

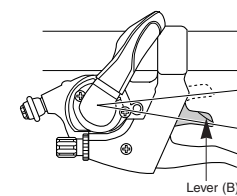

Installation of the rear derailleur

When installing, be careful that deformation is not caused by the B-tension adjustment screw coming into contact with the dropout tab.

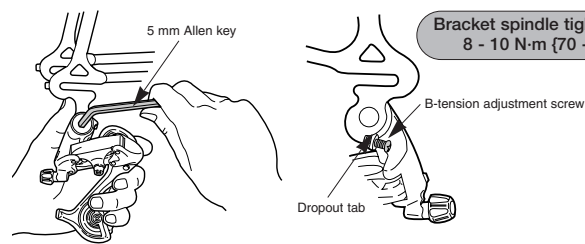

Bracket spindle tightening torque:
8 - 10 N·m [70 - 86 in. lbs.]

Installation of the sprockets

For each sprocket, the surface that has the group mark should face outward and be positioned so that the triangle (▲) mark on each sprocket and the A part (where the groove width is wide) of the freewheel body are aligned.

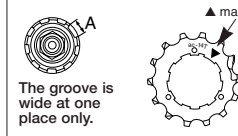

For installation of the HG sprockets, use the special tool (TL-LR15 / LR10) to tighten the lock ring.

Tightening torque:
30 - 50 N·m [261 - 434 in. lbs.]

To replace the HG sprockets, use the special tool (TL-LR15 / LR10) and TL-SR21 to remove the lock ring.

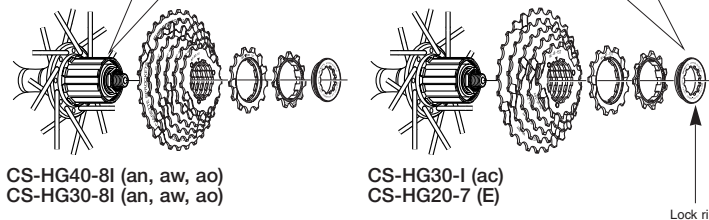
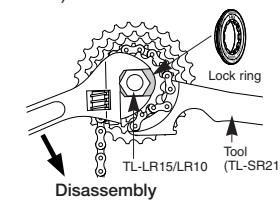

CS-HG40-8I (an, aw, ao)
CS-HG30-8I (an, aw, ao)

CS-HG30-I (ac)
CS-HG20-7 (E)

Chain length

Add 2 links (with the chain on both the largest sprocket and the largest chainring)

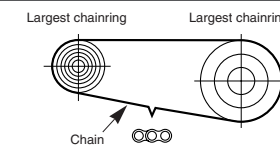

Installation of the shifting lever

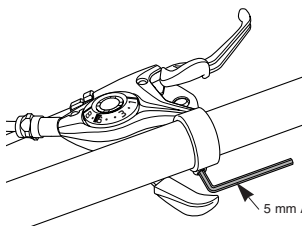

Use a handlebar grip with a maximum outer diameter of 32 mm.

Tightening torque :
6 - 8 N·m [53 - 69 in. lbs.]

SIS Adjustment

1. Top adjustment

Turn the top adjustment screw to adjust so that the guide pulley is in line with the outer line of the smallest sprocket when looking from the rear.

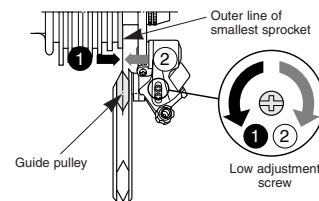

2. Connecting and securing the inner cable

Operate lever (B) at least 7 times to set the lever to the highest position. Remove the screw, and then remove the cover. Pull out the inner cable as shown in Figure, and then install the new inner cable.

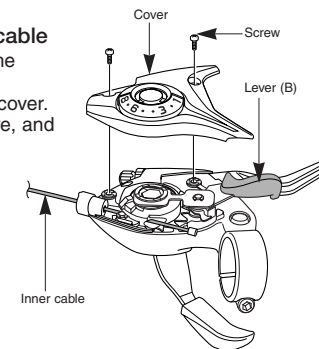

Tightening torque :
0.3 - 0.5 N·m [3 - 4 in. lbs.]

Connect the cable to the rear derailleur and, after taking up the initial slack in the cable, re-secure to the rear derailleur as shown in the illustration.

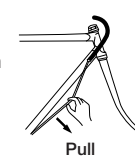

Tightening torque :
5 - 7 N·m [44 - 60 in. lbs.]

Note: Be sure that the cable is securely in the groove.

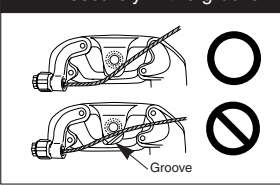

Inserting the inner cable

Insert the inner cable into the outer casing from the end with the marking on it. Apply grease from the end with the marking in order to maintain cable operating efficiency.

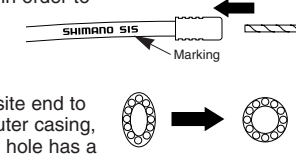

Cutting the outer casing

When cutting the outer casing, cut the opposite end to the end with the marking. After cutting the outer casing, make the end round so that the inside of the hole has a uniform diameter.

Attach the same outer end cap to the cut end of the outer casing.

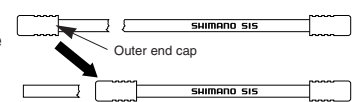

3. Low adjustment

Turn the low adjustment screw so that the guide pulley moves to a position directly in line with the largest sprocket.

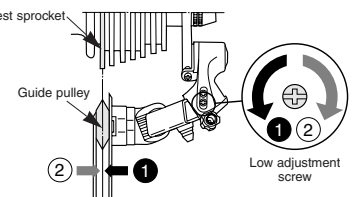

4. How to use the B-tension adjustment screw

Mount the chain on the smallest chainring and the largest sprocket, and turn the crank arm backward. Then turn the B-tension adjustment screw to adjust the guide pulley as close to the sprocket as possible but not so close that it touches. Next, set the chain to the smallest sprocket and repeat the above to make sure that the pulley does not touch the sprocket.

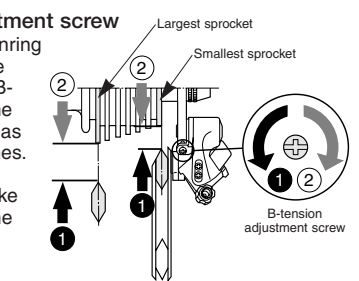

5. SIS Adjustment

Operate the shifting lever several times to move the chain to the 2nd sprocket. Then, while pressing the lever just enough to take up the play in the lever, turn the crank arm.

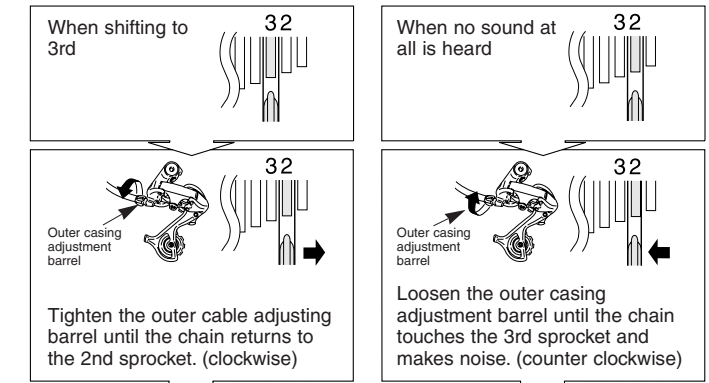

Best setting

The best setting is when the shifting lever is operated just enough to take up the play and the chain touches the 3rd sprocket and makes noise. * Return the lever to its original position (the position where the lever is at the 2nd sprocket setting and it has been released) and then turn the crank arm clockwise. If the chain is touching the 3rd sprocket and making noise, turn the outer casing adjustment barrel clockwise slightly to tighten it until the noise stops and the chain runs smoothly. Operate lever to change gears, and check that no noise occurs in any of the gear positions.

For the best SIS performance, periodically lubricate all power-transmission parts.

Replacement of the freewheel body

After removing the hub axle, remove the freewheel body fixing bolt (inside the freewheel body), and then replace the freewheel body.

Note: Do not attempt to disassemble the freewheel body, because it may result in a malfunction.

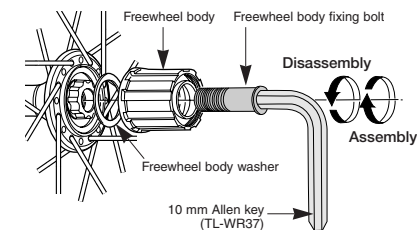

Tightening torque:
35 - 50 N·m [305 - 434 in. lbs.]