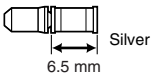
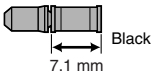

General Safety Information

WARNING – To avoid serious injuries:

- Use neutral detergent to clean the chain. Do not use alkali-based or acid-based detergents such as rust cleaners, as they may result in damage and/or failure of the chain.
- Use the reinforced connecting pin only for connecting the narrow type of chain.
- There are two different types of reinforced connecting pins available. Be sure to check the table below before selecting which pin to use.

Chain	Reinforced connecting pin	Chain tool
9-speed super narrow chain such as CN-7701/CN-HG93	 Silver 6.5 mm	TL-CN31/TL-CN22
8-/7-/6-speed narrow chain such as CN-HG50/CN-IG51	 Black 7.1 mm	TL-CN31/TL-CN22 and TL-CN30/TL-CN21

- If connecting pins other than reinforced connecting pins are used, or if a reinforced connecting pin or tool which is not suitable for that type of chain is used, sufficient connection force may not be obtained, which could cause the chain to break or fall off.
- If it is necessary to adjust the length of the chain due to a change in the number of sprocket teeth, make the cut at some other place than the place where the chain has been joined using a reinforced connecting pin or an end pin.
The chain will be damaged if it is cut at a place where it has been joined with a reinforced connecting pin or an end pin.

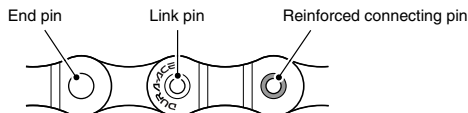

- Check that the tension of the chain is correct and that the chain is not damaged.
If the tension is too weak or the chain is damaged, the chain should be replaced. If this is not done, the chain may break and cause serious injury.
- **Obtain and read the service instructions carefully prior to installing the parts.** Loose, worn, or damaged parts may cause serious injury to the rider. We strongly recommend only using genuine Shimano replacement parts.
- Read these Technical Service Instructions carefully, and keep them in a safe place for later reference.

NOTE:

- Clean the chain tensioner periodically and lubricate all moving parts and pulleys.
- If there is a large amount of play in the pulleys and an abnormal amount of noise is generated while riding, replace the pulleys.
- Parts are not guaranteed against natural wear or deterioration resulting from normal use.
- For any questions regarding methods of handling or maintenance, please contact the place of purchase.

SI-50D0A-002

CT-S500

Chain Tensioner

Technical Service Instructions

SHIMANO
ALFINE

Be sure to read these service instructions in conjunction with the service instructions for the hub for Inter-8 disc brake before use.

Specifications

Front chainwheel tooth difference	16T
Largest sprocket	20T
Smallest sprocket	18T
Applicable dropout width	5 – 9 mm

Installation of the chain tensioner to the frame

Insert a spacer in between the dropout and the chain tensioner so that the guide pulley of the chain tensioner is directly below the sprocket, and then tighten the fixing bolt. One spacer with a thickness of 1 mm and two spacers with a thickness of 2 mm are included.

The total thickness of spacers used should not exceed 5 mm.

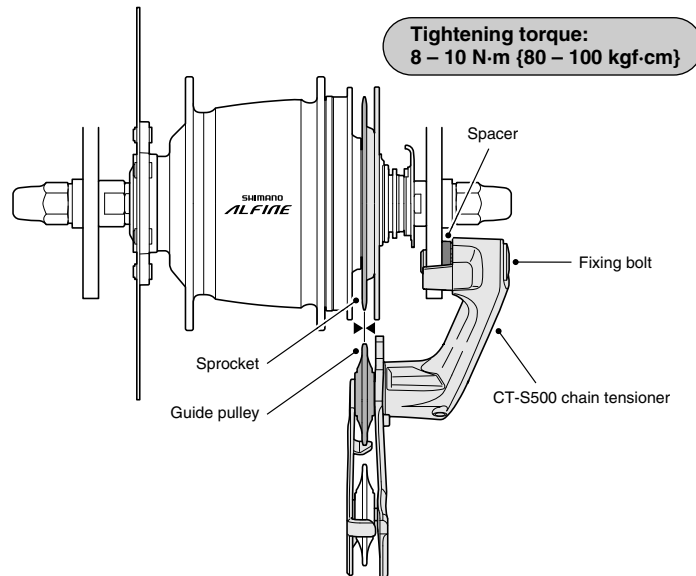

Chain length

If the difference between the number of teeth on the chainrings is 12T or less, or if the front chainwheel has a single chainring, set the chain onto the smaller chainring, and then set the chain tensioner so that the tension pulley and guide pulley are perpendicular to the ground.

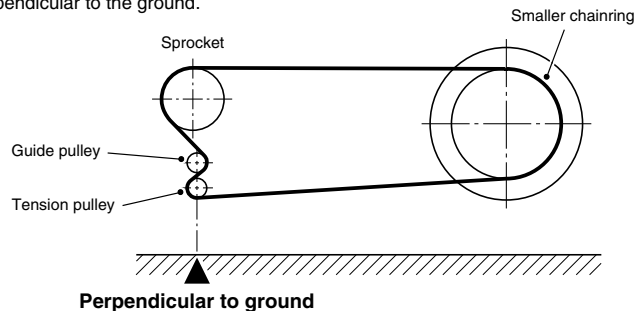

If the difference in the number of chainring teeth is 13T – 16T, make the chain one link longer than this.

These service instructions are printed on recycled paper.

Please note: Specifications are subject to change for improvement without notice. (English)

SHIMANO

SHIMANO AMERICAN CORPORATION

One Holland, Irvine, California 92618, U.S.A. Phone: +1-949-951-5003

SHIMANO EUROPE B.V.

Industrieweg 24, 8071 CT Nunspeet, The Netherlands Phone: +31-341-272222

SHIMANO INC.

3-77 Oimatsu-cho, Sakai-ku, Sakai, Osaka 590-8577, Japan