

General Safety Information

⚠ WARNING

- The two left crank arm mounting bolts should be tightened alternately in stages rather than each bolt being fully tightened all at once. Use a torque wrench to check that the final tightening torques are within the range of 12 - 14 N·m. Furthermore, after riding approximately 100 km (60 miles), use a torque wrench to re-check the tightening torques. It is also important to periodically check the tightening torques. If the tightening torques are too weak or if the mounting bolts are not tightened alternately in stages, the left crank arm may come off and the bicycle may fall over.
- Before riding, you should carefully check your crankset to make sure that there are no cracks, and if you find any sign of a crack or any other unusual condition, do NOT use the bicycle.
- Be careful not to let the cuffs of your clothes get caught in the chain while riding, otherwise you may fall off the bicycle.
- Check that the tension of the chain is correct and that the chain is not damaged. If the tension is too weak or the chain is damaged, the chain should be replaced. If this is not done, the chain may break cause serious injury.
- If the inner cover is not installed correctly, the axle may rust and become damaged, and the bicycle may fall over and serious injury may occur as a result.
- Obtain and read the service instructions carefully prior to installing the parts. Loose, worn or damaged parts may cause the bicycle to fall over and serious injury may occur as a result. We strongly recommend only using genuine Shimano replacement parts.
- Obtain and read the service instructions carefully prior to installing the parts. If adjustments are not carried out correctly, the chain may come off and this may cause you to fall off the bicycle which could result in serious injury.
- Read these Technical Service Instructions carefully, and keep them in a safe place for later reference.

Note

- Make sure that the chainring combination matches the front chainwheel tooth configuration in the Product specifications table. If other combinations are used, the distance between the chainrings will be incorrect and the chain might slip off and get caught in between them.
- When the chain is in the position shown in the illustration, the chain may contact the front chainrings or front derailleur and generate noise. If the noise is a problem, shift the chain onto the next-larger rear sprocket or the one after.
- If the bottom bracket shell is not parallel, gear shifting performance will drop.
- Before riding the bicycle, check that there is no play or looseness in the connection. Also, be sure to retighten the crank arms and pedals at periodic intervals.
- If a squeaking noise is heard coming from the bottom bracket axle and the left crank arm connector, apply grease to the connector and then tighten it to the specified torque.
- If you feel any looseness in the bearings, the bottom bracket should be replaced.
- In addition, if pedaling performance does not feel normal, check this once more.
- Do not wash the bottom bracket with high-pressure jets of water.
- Apply grease to the left and right adapters before installing them.
- To ensure the best performance, be sure to use only the specified type of chain. The wide type of chain cannot be used.
- If the chain keeps coming off the chainrings during use, replace the chainrings and the chain.
- You should periodically wash the chainrings in a neutral detergent and then lubricate them again. In addition, cleaning the chain with neutral detergent and lubricating it can be an effective way of extending the useful life of the chainrings and the chain.
- Parts are not guaranteed against natural wear or deterioration resulting from normal use.
- For maximum performance we highly recommend Shimano lubricants and maintenance products.
- For any questions regarding methods of installation, adjustment, maintenance or operation, please contact a professional bicycle dealer.

Technical Service Instructions

SI-1JS0A-002

FC-M762

Front chainwheel

Specifications

Model number	FC-M762
Chainwheel tooth combination	44-32-22T
Bolt circle diameter	104 mm / 64 mm
Crank arm length	170 mm, 175 mm
Chain line	50 mm
Bottom bracket shell width	68, 73 mm
Thread dimensions	BC1.37 (68, 73 mm)

Installation of the Front Chainwheel and Front Derailleur

Follow the procedure in the figure.

- Use the special tool TL-FC32/36 to install the right adapter (counterclockwise thread) and the left adapter (clockwise thread).
Tightening torque: 35 - 50 N·m {305 - 435 in. lbs.}
- Insert the right crank unit.
- Set section A of the left crank into the axle of the right crank unit where the groove is wide.
- Use the TL-FC16/18 to tighten the cap.
Tightening torque: 0.7 - 1.5 N·m {6 - 13 in. lbs.}
- Push in the stopper plate and check that the plate pin is securely in place, and then tighten the bolt of the left crank arm. (5 mm Allen key)

Note : Each of the bolts should be evenly and equally tightened to 12 - 14 N·m {106 - 122 in. lbs.}.

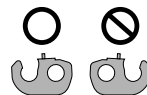
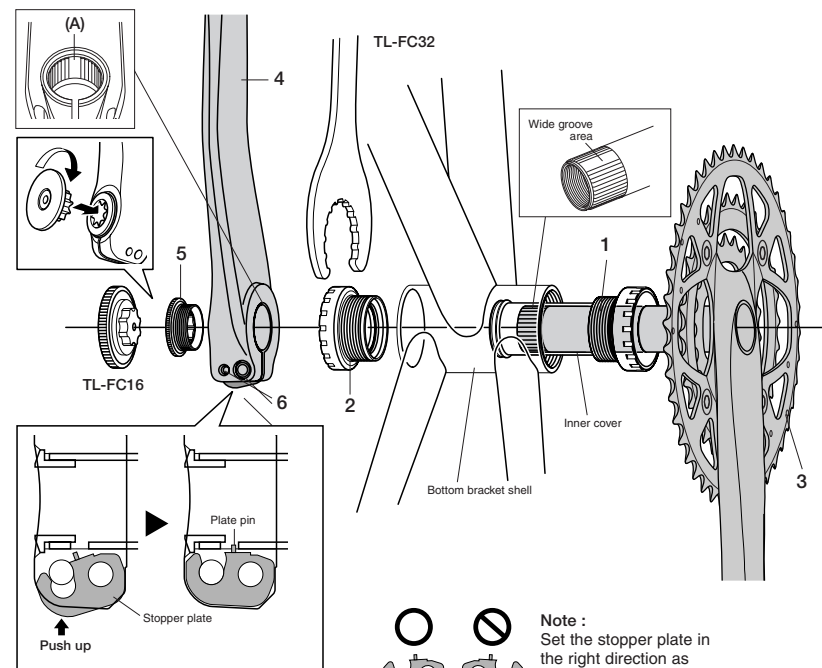

Note :
Set the stopper plate in the right direction as shown in illustration.

Spacer installation method

- Check whether the width of the bottom bracket shell is 68 mm or 73 mm.
- Next, install the adapter while referring to the illustrations below.

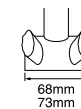

68 mm (Band Type)

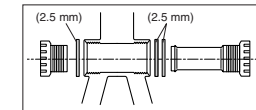

68 mm (Bracket Type)

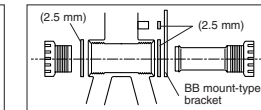

73 mm (Band Type)

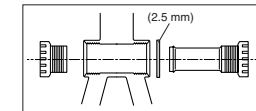

73 mm (Bracket Type)

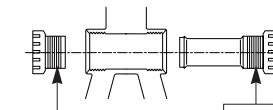
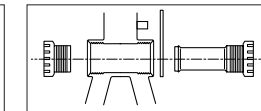

Apply grease to the left and right adapters before installing them.

For bracket type

Install as shown in the illustration.

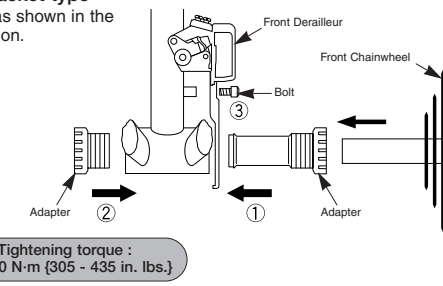

Tightening torque :
35 - 50 N·m {305 - 435 in. lbs.}

- Be sure to read the service instructions for the Front Drive System in conjunction with these service instructions.

SHIMANO

SHIMANO AMERICAN CORPORATION
One Holland, Irvine, California 92618, U.S.A. Phone: +1-949-951-5003

SHIMANO EUROPE B.V.
Industrieweg 24, 8071 CT Nunspeet, The Netherlands Phone: +31-341-272222

SHIMANO INC.
3-77 Oimatsu-cho, Sakai-shi, Osaka 590-8577, Japan

* Service Instructions in further languages are available at :
<http://techdocs.shimano.com>

Please note: specifications are subject to change for improvement without notice. (English)
© Jun. 2009 by Shimano Inc. XBC SZK Printed in Japan.