

Dealer's Manual

ROAD	MTB	Trekking
City Touring/ Comfort Bike	URBAN SPORT	E-BIKE

REVOSHIFT Shifter

SHIMANO

SL-RV100

SL-RV200

SL-RV300

SL-RV400

TOURNEY

SL-RS47

SL-RS45

SL-RS36

SL-RS35

SL-RS34

SL-RS25

Contents

IMPORTANT NOTICE.....	3
TO ENSURE SAFETY.....	4
List of tools to be used	5
Installation / removal	6
Installing the shift lever	6
Adjustment.....	7
Introduction	7
Left-hand lever adjustment.....	7
Right-hand lever adjustment	13
SIS adjustment.....	16
Maintenance.....	19
Replacing the inner cable	19



IMPORTANT NOTICE

- This dealer's manual is intended primarily for use by professional bicycle mechanics. Users who are not professionally trained for bicycle assembly should not attempt to install the components themselves using the dealer's manuals. If any part of the information on the manual is unclear to you, do not proceed with the installation. Instead, contact your place of purchase or a distributor for assistance.
- Make sure to read all manuals included with each product.
- Do not disassemble or modify the product other than as stated in the information contained in this dealer's manual.
- All manuals and technical documents are accessible online at <https://si.shimano.com> .
- For consumers who do not have easy access to the internet, please contact a SHIMANO distributor or any of the SHIMANO offices to obtain a hardcopy of the user's manual.
- Please observe the appropriate rules and regulations of the country, state or region in which you conduct your business as a dealer.

For safety, be sure to read this dealer's manual thoroughly before use, and follow it for correct use.

The following instructions must be observed at all times in order to prevent personal injury and physical damage to equipment and surroundings.

The instructions are classified according to the degree of danger or damage which may occur if the product is used incorrectly.

 DANGER	Failure to follow the instructions will result in death or serious injury.
 WARNING	Failure to follow the instructions could result in death or serious injury.
 CAUTION	Failure to follow the instructions could cause personal injury or physical damage to equipment and surroundings.

TO ENSURE SAFETY

WARNING

- Be sure to follow the instructions provided in the manuals when installing the product.
Only use SHIMANO genuine parts. If a component or replacement part is incorrectly assembled or adjusted, it can lead to component failure and cause the rider to lose control and crash.
-  Wear approved eye protection while performing maintenance tasks such as replacing components.

NOTICE

Be sure to also inform users of the following:

- Be sure to keep turning the crank during the lever operation.
- The gears should be periodically washed with a neutral detergent. In addition, cleaning the chain with neutral detergent and lubricating it can be an effective way of extending the life of the gears and the chain.
- Products are not guaranteed against natural wear and deterioration from normal use and aging.
- For maximum performance we highly recommend SHIMANO lubricants and maintenance products.

For installation to the bicycle and maintenance







- When using a friction-supported front derailleur, use it with one of the following shift levers.

	Shift lever	
		SL-RV100-LN / SL-RV200-LN / SL-RV300-LN / SL-RV400-LN / SL-RS36-LN / SL-RS35-LN / SL-RS34-LN / SL-RS25-LN
Front derailleur FD-TZ31 / FD-TZ30 / FD-TZ21 / FD-TZ20	OK	Not OK

The actual product may differ from the illustration because this manual is intended mainly to explain the procedures for using the product.

List of tools to be used

The following tools are needed for installation/removal, adjustment, and maintenance purposes.

Tool	
	2.5 mm hexagon wrench
	3 mm hexagon wrench
	5 mm hexagon wrench
	9 mm spanner
	Cross head screwdriver
	Cross head screwdriver [#1]
	TL-CT12

Installation / removal

Installing the shift lever

1. Install the shift lever in a position where it will not obstruct brake operation.

- Do not use in a combination which causes brake operation to be obstructed.
- Leave a gap of 0.5 mm between the REVOSHIFT lever and the half grip. There is no need to leave a gap for the SL-RV100 / SL-RV200 / SL-RV300 / SL-RV400.

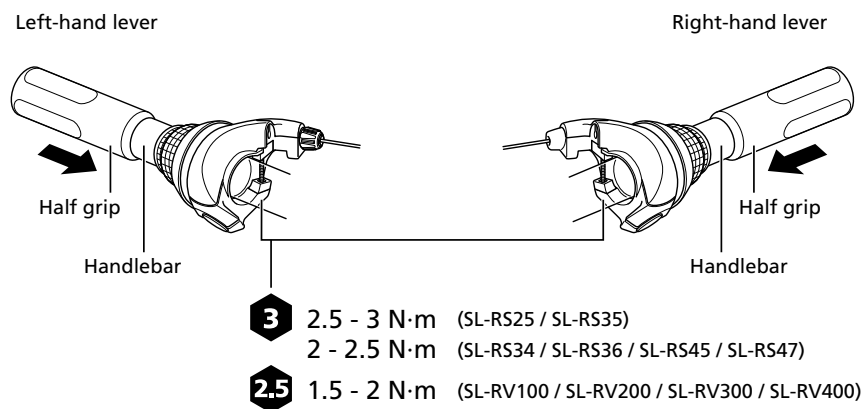

Adjustment

Introduction

Make sure to perform adjustment of the left-hand lever/right-hand lever in each indicated order.

Left-hand lever adjustment

Adjusting the position of the low side

1. For models equipped with the Pro-Set alignment block, remove it.

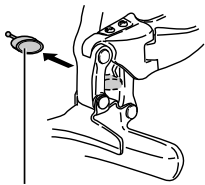

Pro-Set alignment block

2. Shift the chain to the smallest chainring and the largest sprocket.

Largest sprocket

Smallest chainring

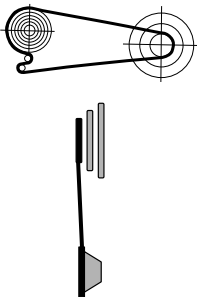

Adjustment

Left-hand lever adjustment

3. Adjust the low position of the front derailleur.

Adjust the gap between the inner plate and chain to 0 - 0.5 mm.

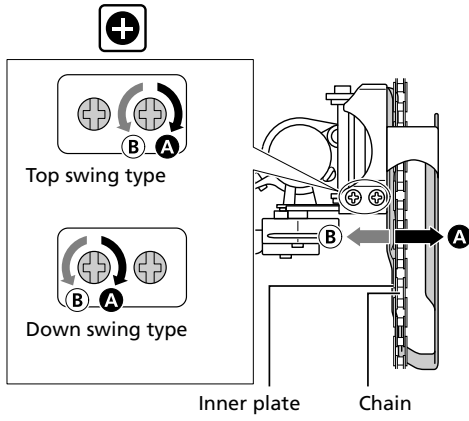

Connection and securing of the inner cable

NOTICE

- Insert the inner cable into the outer casing from the end with the marking on it.
- In order to maintain cable operating efficiency, the end with the marking is greased.

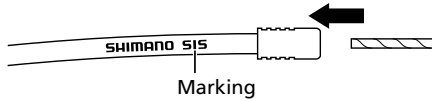

- When cutting the outer casing, cut the opposite end to the end with the marking.
- After cutting, make the end round using a TL-CT12 needle or similar so that the inside of the hole has a uniform diameter.

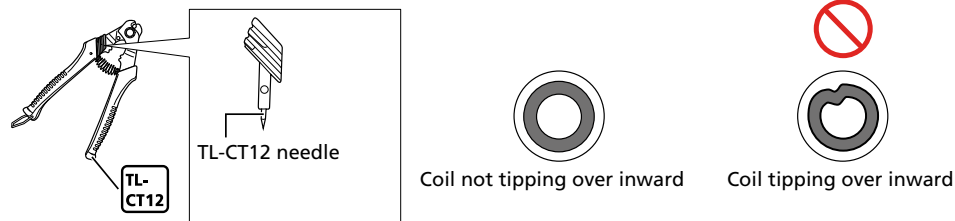

- Attach the same outer cap to the cut end of the outer casing.

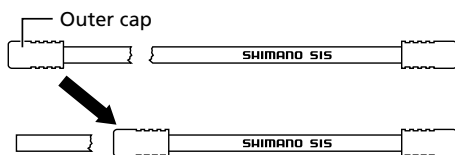

Adjustment

Left-hand lever adjustment

1. While firmly pulling the inner cable, tighten the wire mounting screw to secure the cable in place.

Top swing type: FD-M310 / FD-M315 / FD-TX800 / FD-TY700 / FD-TY710 / FD-TY500 / FD-TY510

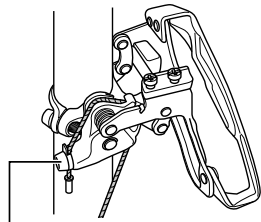

5 5 - 7 N·m

NOTICE

- Route the inner cable as shown in the figure.

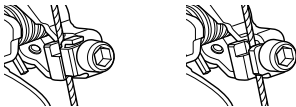

Down swing type: FD-M313 / FD-TY300 / FD-TZ500 / FD-TZ510

Normal type

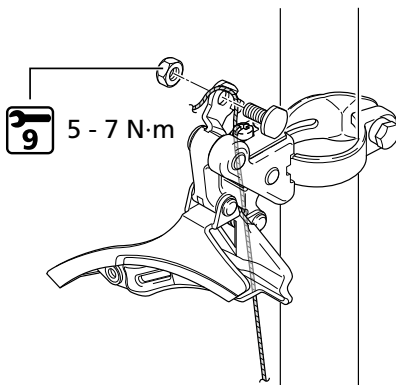

9 5 - 7 N·m

Top route type

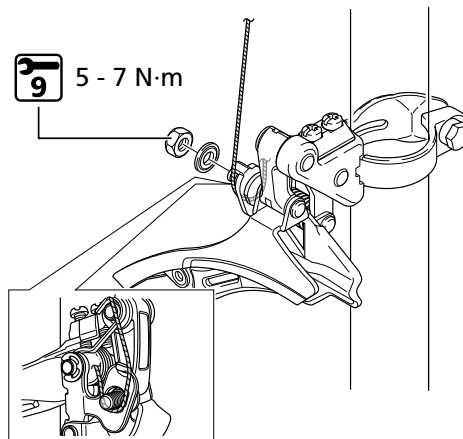

9 5 - 7 N·m

Adjustment

Left-hand lever adjustment

Adjusting the cable tension

1. After taking up the initial slack in the inner cable, re-secure to the front derailleur.

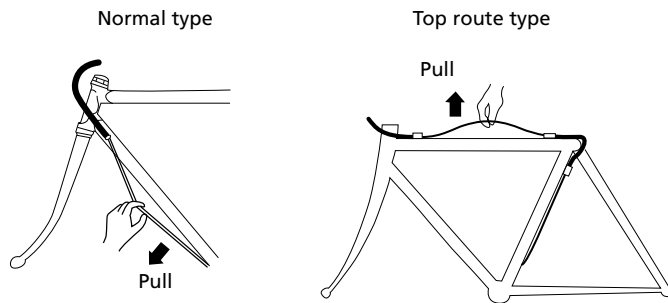

2. Cut off the excess length of inner cable, then install the inner end cap.

Adjusting the high limit

1. Adjust the chain to the largest chainring and the smallest sprocket.

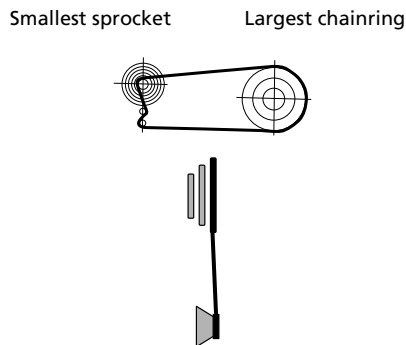

2. Adjust the top position of the front derailleur.

Adjust the gap between the outer plate and chain to 0 - 0.5 mm.

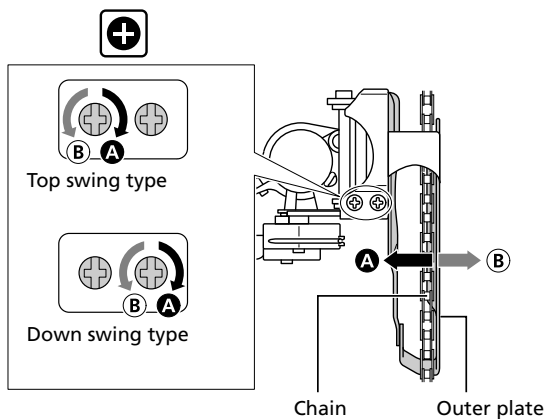

Adjustment

Left-hand lever adjustment

Middle chainring adjustment

This adjustment is not necessary for LN (friction type) as it does not have a cable adjustment barrel.

1. **Set the chain on the largest sprocket, and at the front, move the chain from the largest chainring to the middle chainring to adjust.**

Largest sprocket Middle chainring

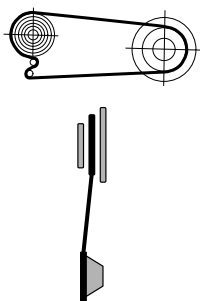

2. **Adjust the middle chainring position of the chain guide.**

Use the cable adjustment barrel to adjust the gap between the inner plate and the chain to 0 - 0.5 mm.

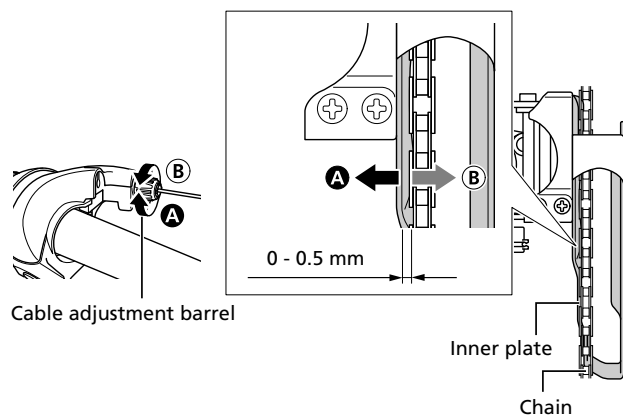

Checking gear shifting and fine adjustment

After completing all adjustment, move the shift lever to check the gear shifting performance. (This also applies if gear shifting becomes difficult during use.)

Adjustment

Right-hand lever adjustment

Situation	Adjustment method
If the chain falls to the crank side	Turn the high limit screw clockwise.
If shifting is difficult from the middle chainring to the largest chainring	Tighten the cable. If this does not improve the situation, turn the high limit screw counterclockwise.
If shifting is difficult from the middle chainring to the smallest chainring	Turn the low limit screw counterclockwise.
If there is interference between the chain and the front derailleur inner plate when the chain is on the largest chainring of the crankset	Turn the high limit screw clockwise.
If there is interference between the chain and the front derailleur outer plate when the chain is on the largest chainring of the crankset	Tighten the cable. If this does not improve the situation, turn the high limit screw counterclockwise.
If the middle chainring is skipped when shifting from the largest chainring	Tighten the cable.
If there is interference between the chain and front derailleur inner plate when the chain is on the largest sprocket at the rear and the middle chainring	Loosen the cable.
If shifting is difficult from the largest chainring to the middle chainring	
If the chain falls to the bottom bracket side	Turn the low limit screw clockwise.

Right-hand lever adjustment

Adjusting the high limit

1. Adjust by turning the high limit screw.

Adjust so that the center of the guide pulley is aligned with the outer face of the smallest sprocket when viewed from the rear side.

* The position of the high limit screw differs depending on the model.

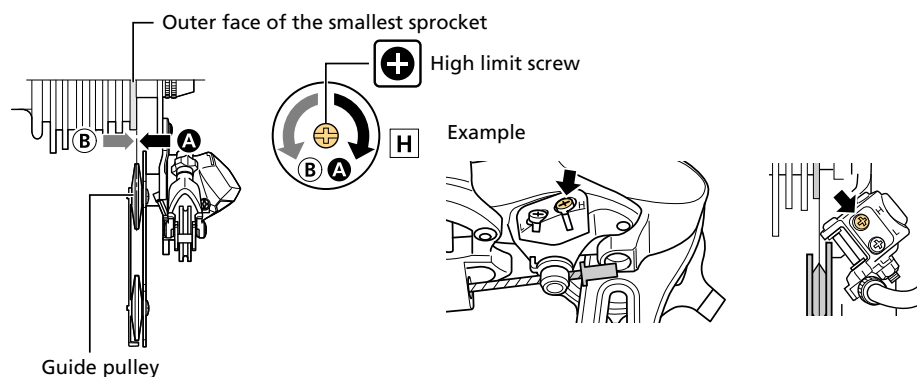

2. Install the chain.

Connection and securing of the inner cable

NOTICE

- Insert the inner cable into the outer casing from the end with the marking on it.
- In order to maintain cable operating efficiency, the end with the marking is greased.

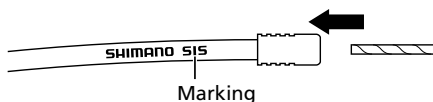

- When cutting the outer casing, cut the opposite end to the end with the marking.
- After cutting, make the end round using a TL-CT12 needle or similar so that the inside of the hole has a uniform diameter.

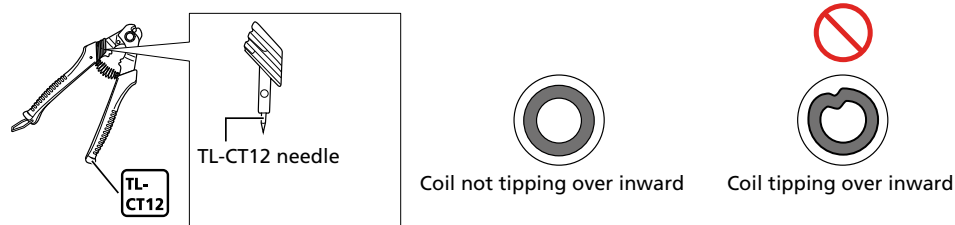

- Attach the same outer cap to the cut end of the outer casing.

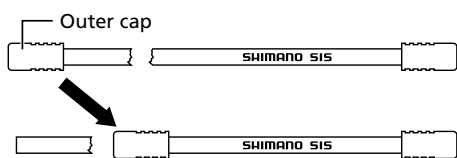

1. Secure the inner cable to the rear derailleur.

Be sure that the inner cable is securely in the cable fixing groove.

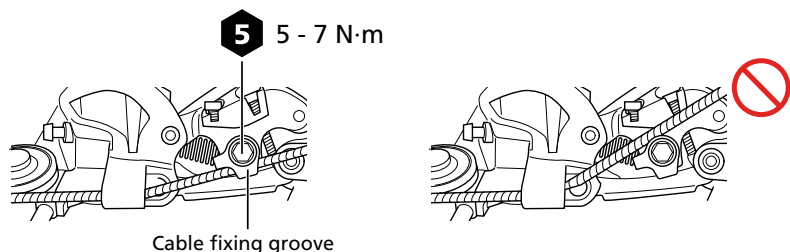

Adjusting the cable tension

1. After taking up the initial slack in the inner cable, re-secure to the rear derailleur.

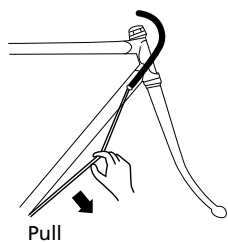

2. Cut off the excess length of inner cable, then install the inner end cap.

Adjusting the low limit

1. While turning the crankset, operate the lever to shift to the largest sprocket.
2. Adjust by turning the low limit screw.

Adjust so that the center of the guide pulley is aligned with the center of the largest sprocket.

* The position of the low limit screw differs depending on the model.

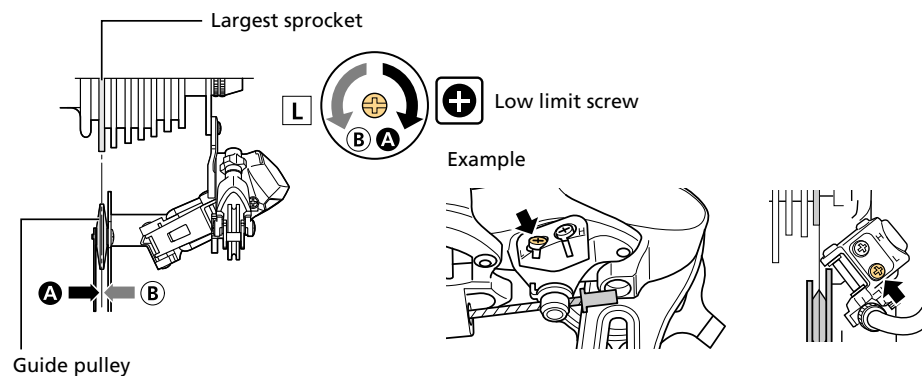

B-tension screw adjustment

RD-M360 / RD-M310 / RD-TX800 / RD-TY500 / RD-TY200-SS / RD-TY200-GS

1. Set the chain on the largest sprocket and smallest chainring, and turn the crank arm backward.
2. Turn the B-tension screw to adjust the guide pulley to be as close to the gear as possible but not so close that it touches.
3. Set the chain on the smallest sprocket and repeat the above to make sure that the chain tension is correct.

RD-TY21B / RD-TZ500

1. In order to obtain suitable gear shifting performance, set the chain onto the largest sprocket and the smallest chainring.
2. Turn the B-tension screw to adjust so that the distance between the tip of the freewheel and the tip of the guide pulley is 10 mm.

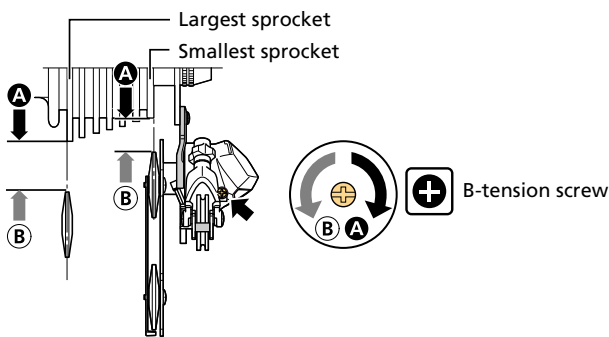

3. Set the chain on the smallest sprocket and repeat the above to make sure that the chain tension is correct.

SIS adjustment

1. Operate the shift lever once to move the chain from the smallest sprocket to the 2nd sprocket.

2. While operating the lever just enough to close the play in the lever, turn the crank arm.

TECH TIPS

- The best setting is when the shift lever is operated just enough to close the lever play and the chain touches the 3rd sprocket counting from the smallest sprocket and makes noise.

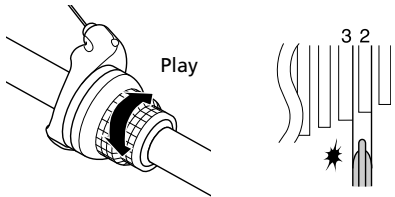

When shifting to the 3rd sprocket counting from the smallest sprocket

Tighten the adjustment barrel until the chain returns to the 2nd sprocket counting from the smallest sprocket. (Clockwise)

* The position of the adjustment barrel differs depending on the model.

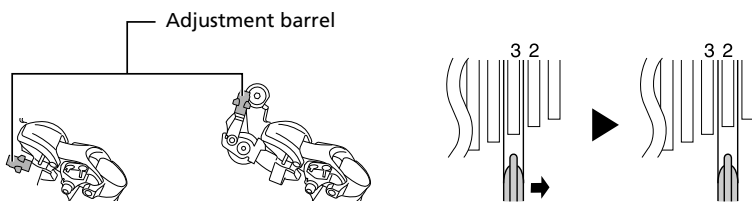

When no sound at all is generated

Loosen the adjustment barrel until the chain touches the 3rd sprocket counting from the smallest sprocket and makes noise. (Counterclockwise)

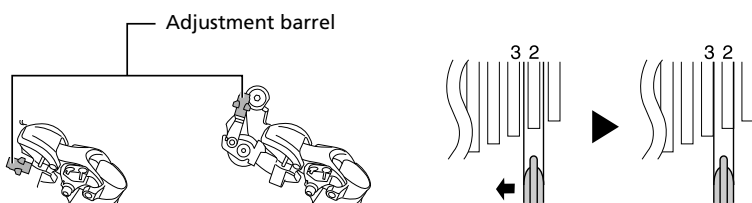

3. Return the lever to its original position (the position where the lever is at the 2nd sprocket setting counting from the smallest sprocket and it has been released), then turn the crank arm.

If the chain is touching the 3rd sprocket counting from the smallest sprocket and making noise, turn the adjustment barrel clockwise slightly to tighten it just enough until the noise stops.

4. Operate the lever to change gears, and check that no noise occurs in any of the gear positions.

Adjustment

SIS adjustment

5. For the best SIS performance, periodically lubricate all power-transmission parts.

Maintenance

Replacing the inner cable

SL-RS47 / SL-RS45 / SL-RS36 / SL-RS35 / SL-RS34 / SL-RS25 / SL-RV400

1. Operate the shifter to align the gear with the top (for the rear) or low (for the front) position.
2. Remove the cover.

Left-hand lever

SL-RS47 / SL-RS45 /
SL-RS36 / SL-RS34 /
SL-RV400

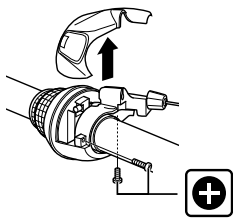

SL-RS35 / SL-RS25

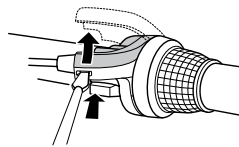

Right-hand lever

SL-RS47 / SL-RS45 /
SL-RS36 / SL-RS34 /
SL-RV400

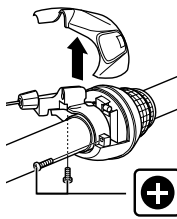

SL-RS35 / SL-RS25

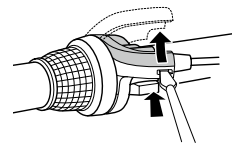

3. Follow the procedures in (1) - (3) to replace the inner cable.

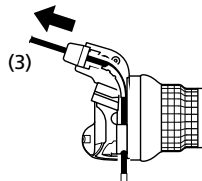
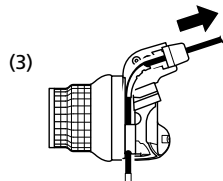
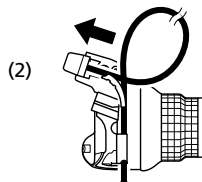
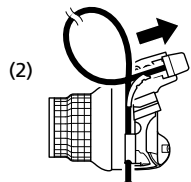
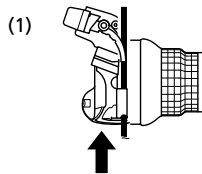
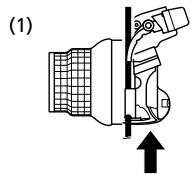



4. Install the cover.

Left-hand lever

SL-RS47 / SL-RS45 /
SL-RS36 / SL-RS34 /
SL-RV400

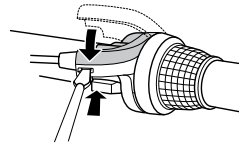
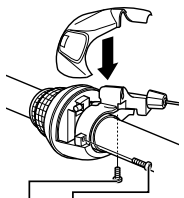
SL-RS35 / SL-RS25





-  0.1 - 0.25 N·m
(SL-RS47 / SL-RS45 / SL-RS36 / SL-RV400)
- 0.1 - 0.2 N·m
(SL-RS34)
-  0.1 - 0.25 N·m
(SL-RS47 / SL-RS45 / SL-RS36 / SL-RV400)
- 0.1 - 0.2 N·m
(SL-RS34)

Right-hand lever

SL-RS47 / SL-RS45 /
SL-RS36 / SL-RS34 /
SL-RV400

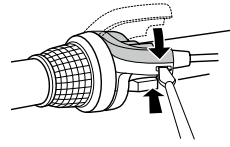
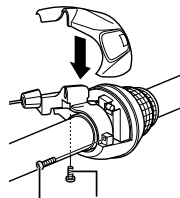
SL-RS35 / SL-RS25



-  0.1 - 0.25 N·m
(SL-RS47 / SL-RS45 / SL-RS36 / SL-RV400)
- 0.1 - 0.2 N·m
(SL-RS34)
-  0.1 - 0.25 N·m
(SL-RS47 / SL-RS45 / SL-RS36 / SL-RV400)
- 0.1 - 0.2 N·m
(SL-RS34)

SL-RV100 / SL-RV200 / SL-RV300

1. Turn over the rubber grip from the area with the triangle mark.

Ensure that the inner head of the inner cable can be seen.

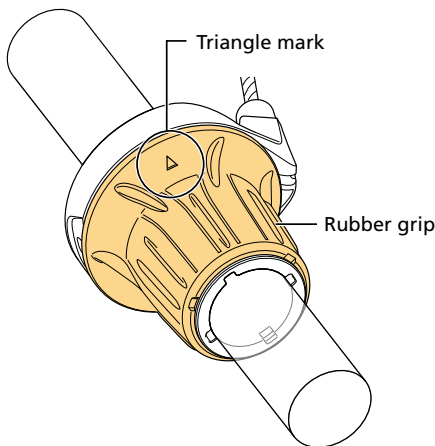

Maintenance

Replacing the inner cable

2. Pull out the inner head and remove the inner cable.

Use a sharp tool, etc. to pull out the inner head.

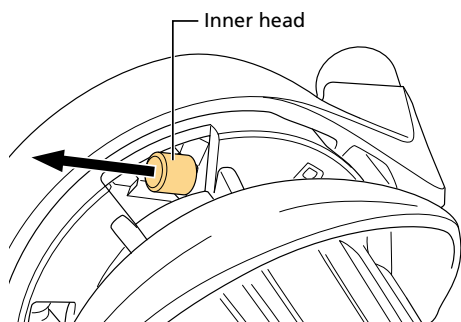

3. Insert a new inner cable into the hole.

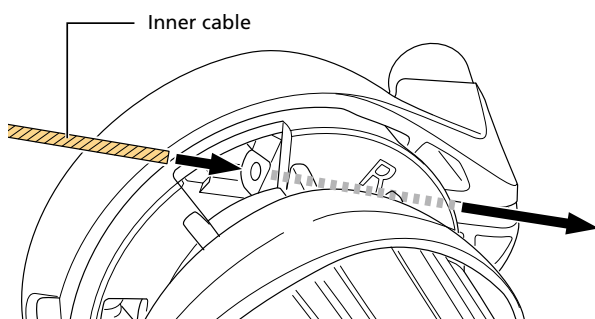

4. Pass the inner cable through the bracket, and out from the stopper area of the outer casing.

