

Dealer's Manual

ROAD	MTB	Trekking
City Touring/ Comfort Bike	URBAN SPORT	E-BIKE

Dual Pivot Caliper Brake

SORA

BL-R3000
BR-R3000

CLARIS

BL-R2000
BR-R2000

Brake cable

BC-1051

CONTENTS

IMPORTANT NOTICE.....	3
TO ENSURE SAFETY.....	4
LIST OF TOOLS TO BE USED.....	8
INSTALLATION	10
Mode switching.....	10
Installation of the brake lever.....	11
Installation of the brake cable.....	11
Checking the brakes.....	12
Installation of the brake caliper.....	12
ADJUSTMENT	16
Readjustment of shoe clearance (When brake shoes are worn).....	16
MAINTENANCE	18
Reach adjustment.....	18
Brake shoe characteristics.....	19

IMPORTANT NOTICE

- **This dealer's manual is intended primarily for use by professional bicycle mechanics.**

Users who are not professionally trained for bicycle assembly should not attempt to install the components themselves using the dealer's manuals. If any part of the information on the manual is unclear to you, do not proceed with the installation. Instead, contact your place of purchase or a local bicycle dealer for their assistance.

- Make sure to read all instruction manuals included with the product.
- Do not disassemble or modify the product other than as stated in the information contained in this dealer's manual.
- All dealer's manuals and instruction manuals can be viewed on-line on our website (<http://si.shimano.com>).
- Please observe the appropriate rules and regulations of the country, state or region in which you conduct your business as a dealer.

For safety, be sure to read this dealer's manual thoroughly before use, and follow it for correct use.

The following instructions must be observed at all times in order to prevent personal injury and physical damage to equipment and surroundings. The instructions are classified according to the degree of danger or damage which may occur if the product is used incorrectly.



Failure to follow the instructions will result in death or serious injury.



Failure to follow the instructions could result in death or serious injury.



Failure to follow the instructions could cause personal injury or physical damage to equipment and surroundings.

TO ENSURE SAFETY

WARNING

- **Be sure to follow the instructions provided in the manuals when installing the product.**

It is recommended to use genuine Shimano parts only. If parts such as bolts and nuts become loose or damaged, the bicycle may suddenly fall over, which may cause serious injury. In addition, if adjustments are not carried out correctly, problems may occur, and the bicycle may suddenly fall over, which may cause serious injury.

-  Be sure to wear safety glasses or goggles to protect your eyes while performing maintenance tasks such as replacing parts.
- After reading the dealer's manual thoroughly, keep it in a safe place for later reference.

Be sure to also inform users of the following:

- Each bicycle may handle slightly differently depending on the model. Therefore, be sure to learn the proper braking technique (including brake lever pressure and bicycle control characteristics) and operation of your bicycle. Improper use of your bicycle's brake system may result in a loss of control or a fall, which could lead to severe injury. For proper operation, consult a professional bicycle dealer or the bicycle's owner's manual. It is also important to practice riding and braking, etc.
- If the front brake is applied too strongly, the wheel may lock and the bicycle may fall forward, and serious injury may result.
- Always make sure that the front and rear brakes are working correctly before riding the bicycle.
- The required braking distance will be longer during wet weather. Reduce your speed and apply the brakes early and gently.
- If the road surface is wet, the tires will skid more easily. If the tires skid, you may fall off the bicycle; therefore, to avoid this, reduce your speed and apply the brakes early and gently.
- Be careful not to allow any oil or grease to get onto the brake shoes. If any oil or grease does get on the brake shoes, contact the place of purchase or a bicycle dealer. Otherwise the brakes may not work correctly.
- Check the brake cable for rust, fraying, and cracks, and contact the place of purchase or a bicycle dealer if any such problems are found. If the brakes do not work correctly, it is dangerous.
- Because of the characteristics of the carbon fiber material, the lever should never be altered. Otherwise, the lever may break preventing braking operation.
- Check before riding that there is no damage such as carbon peeling or cracking. If there is any damage, stop using the bicycle and consult a dealer or an agency. Otherwise, the lever may break preventing braking operation.

For Installation to the Bicycle, and Maintenance:

- The brake levers are equipped with a mode switching mechanism to make them compatible with V-BRAKE brakes, caliper brakes, cantilever brakes and road mechanical disc brakes.
- If the incorrect mode is selected it may result in either excessive or insufficient braking force, which is highly dangerous. Select the correct mode as shown in the illustrations.

Applicable brake:

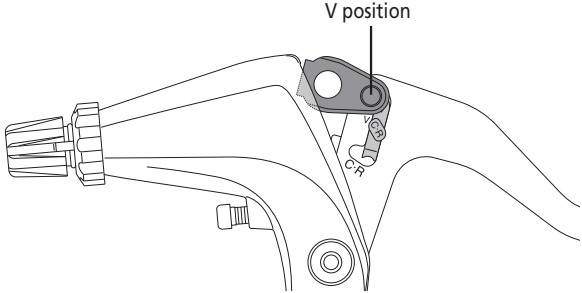
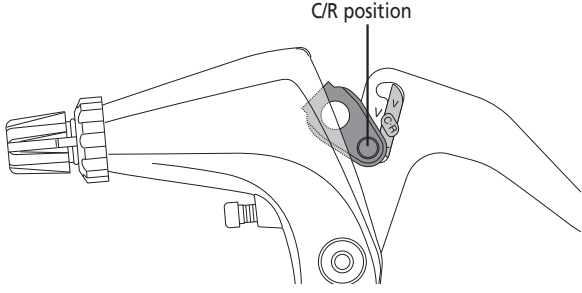
V-BRAKE brakes	Caliper brakes Cantilever brakes Road mechanical disc brakes
 <p>V position</p> <p>V: Mode position for compatibility with V-BRAKE brakes</p>	 <p>C/R position</p> <p>C: Mode position for compatibility with caliper brakes and cantilever brakes R: Mode position for compatibility with road mechanical disc brakes</p>

- Use the dual control lever or brake lever in the combinations specified in the following table. Do not use the combinations with the "NO!" indication in the table. The brakes may be excessively effective, and you may fall.

Caliper brakes	Combinations	Dual control lever	Brake lever
BR-R3000 BR-R2000	OK	ST-R3000/ST-R3030 ST-R2000/ST-R2030	BL-R3000/BL-R2000
		Dual control lever for road bikes other than the above	Brake levers not included above

 : The "NO!" symbols indicate combinations that should not be used under any circumstances.

- Securely tighten the caliper brake mounting nuts to the specified tightening torque.
- For sunken nut type brakes, use sunken nuts of the appropriate length which can be turned six times or more; when re-installing, apply sealant (locking adhesive) to the nut threads.
- If the nuts become loose and the brakes fall off, they may get caught up in the bicycle and the bicycle may fall over. In particular, if this happens with the front wheel, the bicycle may be thrown forward and serious injury could result.
- Brakes designed for use as rear brakes should not be used as front brakes.

NOTE**Be sure to also inform users of the following:**







- In the case of carbon levers, wash them with a soft cloth using a neutral detergent. Otherwise, the material may break down and be damaged.
- Avoid leaving the carbon levers in areas of high temperature. Also keep them well away from fire.
- When combined with a ceramic rim, Shimano road brake shoes wear down more quickly.
- If the brake shoes have worn down until the grooves are no longer visible, consult a dealer or an agency.
- Different brake shoes have their own characteristics. Ask the dealer or the agency for details when purchasing the brake shoes.
- Products are not guaranteed against natural wear and deterioration from normal use and aging.
- For maximum performance we highly recommend Shimano lubricants and maintenance products.

The actual product may differ from the illustration because this manual is intended mainly to explain the procedures for using the product.

LIST OF TOOLS TO BE USED

LIST OF TOOLS TO BE USED

The following tools are needed for installation, adjustment, and maintenance purposes.

Tool		Tool		Tool	
	2mm hexagon wrench		4mm hexagon wrench		Screwdriver[#1]
	3mm hexagon wrench		5mm hexagon wrench		TL-CT12

INSTALLATION

INSTALLATION

Mode switching

The mode switching mechanism differs depending on the model.

If the incorrect mode is selected it may result in either excessive or insufficient braking force, which is highly dangerous. Select the correct mode as shown in the illustrations.

Applicable brake:

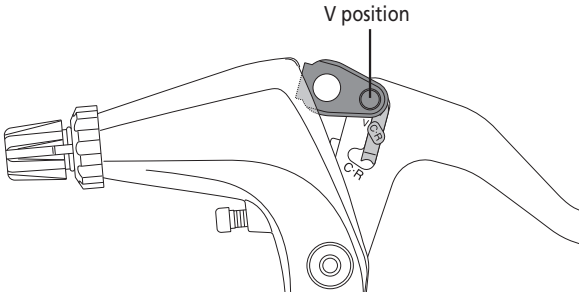
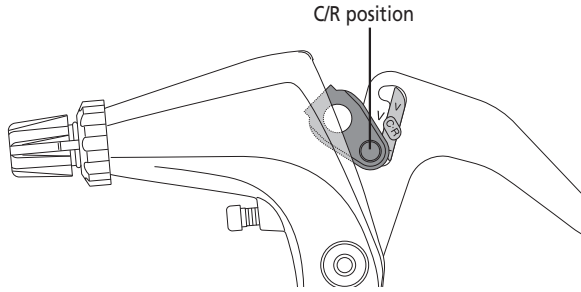
V-BRAKE brakes	Caliper brakes Cantilever brakes Road mechanical disc brakes
 <p>V position</p> <p>V: Mode position for compatibility with V-BRAKE brakes</p>	 <p>C/R position</p> <p>C: Mode position for compatibility with caliper brakes and cantilever brakes R: Mode position for compatibility with road mechanical disc brakes</p>

1

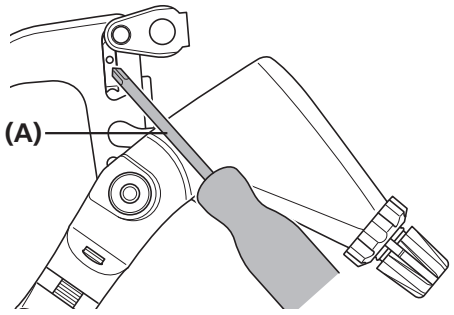

(A)

Use screwdriver[#1] to loosen the screw.

(A) Screwdriver[#1]

2

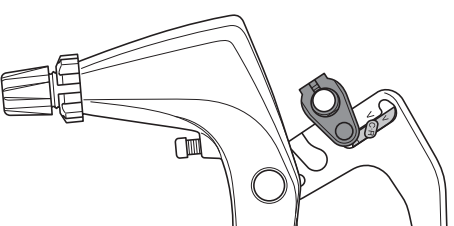

Align the mode switch with the position of the brake installed.

■ Installation of the brake lever

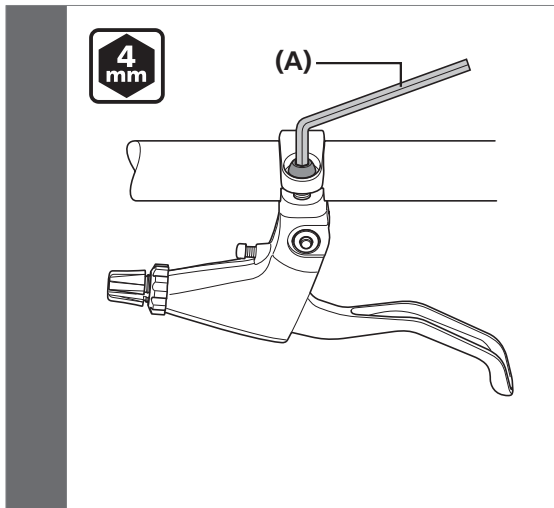

Use a 4mm hexagon wrench to install.

Use a handlebar grip with an outer diameter of Ø32mm or less.

(A) 4mm hexagon wrench

Tightening torque	
	6 - 8 N·m

NOTE

Even with the recommended tightening torque, there is a possibility that the carbon handlebars may become damaged and insufficiently tightened. Confirm the appropriate torque with the bicycle manufacturer or the handlebar manufacturer.

■ Installation of the brake cable

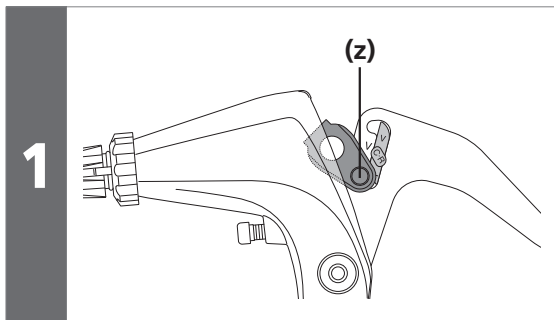

Move the mode switch on the brake lever to the C/R position.

(z) C/R position

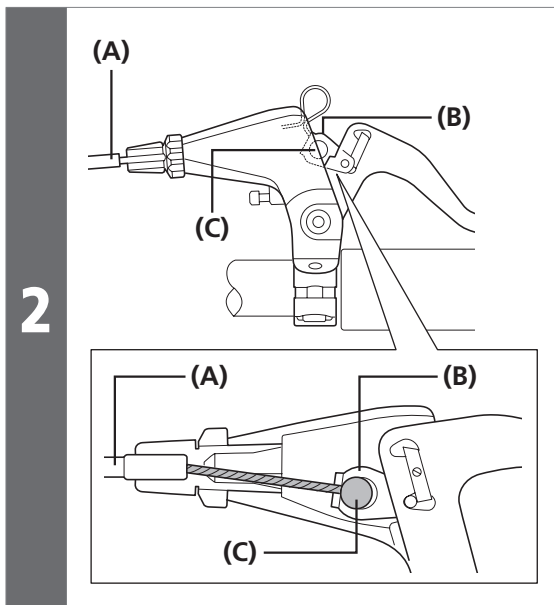

Set the inner cable drum of the brake cable into the cable hook.

- (A)** Outer casing
- (B)** Cable hook
- (C)** Inner cable drum

NOTE

Cut the cable to a length at which it has some length to spare even when the handlebars are turned all the way to either side.

INSTALLATION

▶ Checking the brakes

■ Checking the brakes

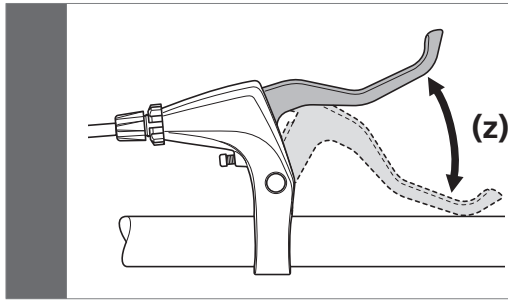

After installing the brake cable on the side of the caliper brake, depress the brake lever until it touches the grip about ten times to check shoe clearance and each section for any abnormality before use.

(z) Depress about 10 times

■ Installation of the brake caliper

Recommended tire size/rim width

Compatible tire sizes	Thickness	Circumference
	Ø28mm or less	Ø684mm or less

Compatible rim widths	Rim	Rim width	Remarks
	Aluminum rim	19 - 28mm	-
Carbon rim	19 - 28mm	Please use R55C4-1 (for carbon rims)	

NOTE

- When using a carbon rim with a rim width of 19 to 28mm use the R55C4-1 (for carbon rims).
- Front brakes cannot be installed as rear brakes and vice versa.

Installation

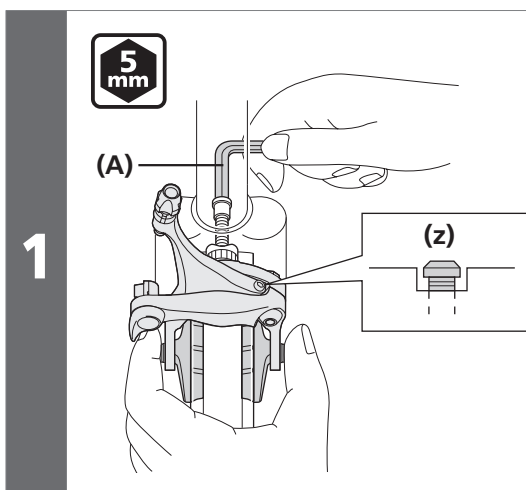

Install the brake caliper. Compress the arch, and set while the shoe is in firm contact with the rim.

(z) The usual position during installation is when the head of the centering adjustment bolt is as shown in the illustration.

(A) 5mm hexagon wrench

Tightening torque



8 - 10 N·m

NOTE

If the brake arm touches the frame when the handlebar is turned, attach the included frame protection sticker to the frame.

INSTALLATION

Installation of the brake caliper

2

Adjust the brake shoe position and then secure in place the brake shoe. After adjusting the brake shoe position so that the shoe surface and the rim surface are as shown in the illustration, tighten the shoe fixing bolt.

- (x) Direction of rim rotation
- (y) Toe-in 0.5mm
- (z) 1mm or more

- (A) Shoe fixing bolt
- (B) 4mm hexagon wrench

Tightening torque	
	5 - 7 N·m

3

Install the brake cable(BC-1051). Set the quick release lever to the closed position; then adjust the shoe clearance (as shown in the illustration) and secure the cable.

- (x) Open
- (y) Close
- (z) [A] + [B] = 3 - 4mm

- (A) Centering adjustment bolt
- (B) 3mm hexagon wrench
- (C) Quick release lever

Tightening torque	
	6 - 8 N·m

4

3 mm

(A) Centering adjustment bolt
(B) 3mm hexagon wrench

(x) Open
(y) Close
(z) [A] + [B] = 3 – 4mm

5

(A) Cable adjustment nut

(z) [A] + [B] = 3 – 4mm

6

Check the brakes. Depress the brake lever about 10 times until it touches the grip and check that everything is operating correctly and that the shoe clearance is correct before using the brakes.

(z) Depress about 10 times

TECH TIPS

For models with a CLOSE position mark on the quick release lever and brake body side, align the marks. At this time, check for a click.

CLOSE position mark

ADJUSTMENT

ADJUSTMENT

■ Readjustment of shoe clearance (When brake shoes are worn)

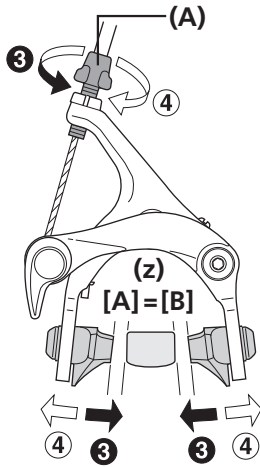

Wear and tear of the brake shoes increases the clearance between the shoes and the rim. To deal with this, re-adjust shoe clearance by turning the cable adjustment nut.

- Adjust cable tension with the cable adjustment nut.
- When the grooves of a brake shoe are worn away, replace the brake shoe.

(z) $[A] + [B] = 3 - 4\text{mm}$

(A) Cable adjustment nut

MAINTENANCE

MAINTENANCE

■ Reach adjustment

1

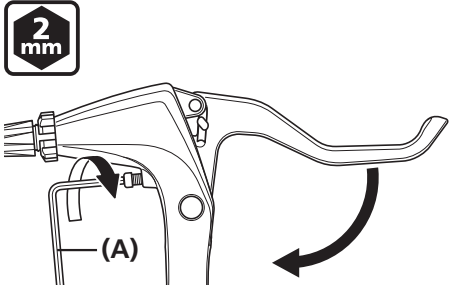

Turning it clockwise reduces the reach.

(A) 2mm hexagon wrench



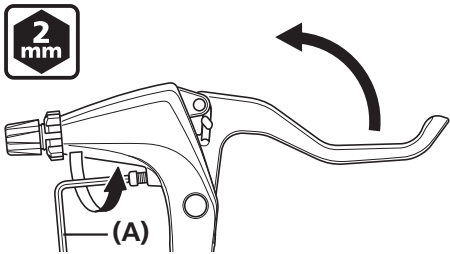





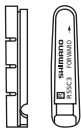

2

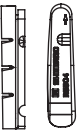
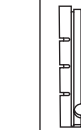

Turning it counterclockwise increases the reach.

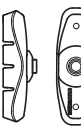
(A) 2mm hexagon wrench

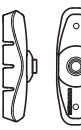
■ Brake shoe characteristics

Model No.	R55C4	R55C2	R55C3	R55C4 for Carbon rim	R55C4-1 for Carbon rim	R55C+1	R55CT4	M50T	R50T	R50T2	R50T4	R50T5	
Brake shoe shape													
Cartridge type	x	x	x	x	x	x	x	-	-	-	-	-	
Recommended rim	Aluminum	Aluminum	Aluminum	Carbon	Carbon	Aluminum	Aluminum	Aluminum	Aluminum	Aluminum	Aluminum	Aluminum	
Characteristics	DRY Power	★★★★★	★★★★★	★★★★★	★★★★☆	★★★★☆	★★★★☆	★★★★☆	★★★★☆	★★★★☆	★★★★☆	★★★★★	
	WET Power	★★☆☆☆	★★☆☆☆	★★☆☆☆	★★☆☆☆	★★☆☆☆	★★☆☆☆	★★☆☆☆	★★☆☆☆	★★☆☆☆	★★☆☆☆	★★☆☆☆	
	Silence	★★★★☆	★★★★☆	★★★★☆	★★★★☆	★★★★☆	★★★★☆	★★★★★	★★★★☆	★★★★☆	★★★★☆	★★★★☆	
	Anti-fading	★★★★★	★★★★★	★★★★★	★★★★★	★★★★★	★★★★★	★★★★☆	★★★★★	★★★★★	★★★★★	★★★★☆	★★★★★
	Durability (on road)	★★★★★	★★★★★	★★★★★	★★★★★	★★★★☆	★★★★☆	★★★★☆	★★★★☆	★★★★☆	★★★★☆	★★★★☆	★★★★★
	Durability (muddy condition)	★★★★★	★★★★★	★★★★★	★★★★★	★★★★☆	★★★★☆	★★★★☆	★★★★☆	★★★★☆	★★★★☆	★★★★☆	★★★★☆
	Anti rim-attack	★★★★☆	★★★★★	★★★★☆	★★★★☆	★★★★☆	★★★★★	★★★★☆	★★★★☆	★★★★★	★★★★★	★★★★☆	★★★★☆
	-	-	-	-	-	-	-	-	-	-	Option	Standard	

SHIMANO

SHIMANO AMERICAN CORPORATION

One Holland, Irvine, California 92618, U.S.A. Phone: +1-949-951-5003

SHIMANO EUROPE B.V.

Industrieweg 24, 8071 CT Nunspeet, The Netherlands Phone: +31-341-272222

SHIMANO INC.

3-77 Oimatsu-cho, Sakai-ku, Sakai-shi, Osaka 590-8577, Japan

Please note: specifications are subject to change for improvement without notice. (English)

© Nov. 2016 by Shimano Inc. ITP