

Dealer's Manual

ROAD	MTB	Trekking
City Touring/ Comfort Bike	URBAN SPORT	E-BIKE

Crankset

DURA-ACE

FC-R9200

ULTEGRA

FC-R8100

SHIMANO 105

FC-R7100

Bottom Bracket

BB-R9100

BB-RS501

BB-RS500

BB-RS500-PB

SM-BBR60

SM-BB92-41B

SM-BB72-41B

Non-Series

FC-RS520

Contents

IMPORTANT NOTICE.....	3
TO ENSURE SAFETY.....	4
List of tools to be used	8
Installation/removal	9
Installing/removing the bottom bracket	9
Installing/removing the crankset	19
Maintenance.....	22
Replacing the chainring.....	22



IMPORTANT NOTICE

- This dealer's manual is intended primarily for use by professional bicycle mechanics.
Users who are not professionally trained for bicycle assembly should not attempt to install the components themselves using the dealer's manuals.
If any part of the information on the manual is unclear to you, do not proceed with the installation. Instead, contact your place of purchase or a distributor for assistance.
- Make sure to read all manuals included with each product.
- Do not disassemble or modify the product other than as stated in the information contained in this dealer's manual.
- All manuals and technical documents are accessible online at <https://si.shimano.com> .
- For consumers who do not have easy access to the internet, please contact a SHIMANO distributor or any of the SHIMANO offices to obtain a hardcopy of the user's manual.
- Please observe the appropriate rules and regulations of the country, state or region in which you conduct your business as a dealer.

For safety, be sure to read this dealer's manual thoroughly before use, and follow it for correct use.

The following instructions must be observed at all times in order to prevent personal injury and physical damage to equipment and surroundings.

The instructions are classified according to the degree of danger or damage which may occur if the product is used incorrectly.

 DANGER	Failure to follow the instructions will result in death or serious injury.
 WARNING	Failure to follow the instructions could result in death or serious injury.
 CAUTION	Failure to follow the instructions could cause personal injury or physical damage to equipment and surroundings.

TO ENSURE SAFETY

WARNING

- Be sure to follow the instructions provided in the manuals when installing the product.
Only use SHIMANO genuine parts. If a component or replacement part is incorrectly assembled or adjusted, it can lead to component failure and cause the rider to lose control and crash.
-  Wear approved eye protection while performing maintenance tasks such as replacing components.

Be sure to also inform users of the following:

- Never use alkali- or acid-based solvents such as rust cleaners. If those solvents are used the chain might break and cause serious injury.
- Clean the chain with an appropriate chain cleaner regularly. Intervals between maintenance depend on the use and riding circumstances.
- Check that there are no cracks in the crank arms before riding the bicycle. If there are any cracks, the crank arm may break and you may fall off the bicycle.
- Be careful not to let the hemming of your clothes get caught in the chain while riding. Otherwise, you may fall off the bicycle.
- Check the chain for any damage (deformation or cracking), skipping, or other abnormalities such as unintended gear shifting. If any problems are found, consult your place of purchase or a distributor. The chain may break, and you may fall.

For installation to the bicycle and maintenance

- Install the inner cover correctly. If it is not installed correctly, the axle may rust and become damaged, and the bicycle may fall over and serious injury may occur as a result.
- The two left crank arm screws should be tightened alternately in stages rather than each fully tightened at once. Use a torque wrench to check that the tightening torques are within the range of 12 - 14 N·m. Also, after riding approximately 100 km (60 miles), use a torque wrench to re-check the tightening torques. Thereafter, continue to check the tightening torques periodically. If the tightening torques are too weak or if the mounting screws are not tightened alternately in stages, the left crank arm may come off and the bicycle may fall over, and serious injury may occur as a result.
- Re-checking the tightening torque of the crank arm is necessary when the crank arm is subjected to strong blows from a fall. If riding when the tightening torque is weak due to a strong blow, the crank arm could detach and you may fall off the bicycle.

 **CAUTION**



Be sure to also inform users of the following:

- Be careful not to touch the teeth of chainrings. There is a danger of injury.

NOTICE

Be sure to also inform users of the following:

- Be sure to keep turning the crank arm during the shift lever operation.
- When the chain is in any of the positions shown in the figures, the chain may come into contact with the chainring or front derailleur and generate noise. If noise is a problem, shift the chain onto the next largest sprocket or the one after it.

	Double
Chainring	
Sprocket	

- Check that there is no excess play or looseness in any fastening sections before riding the bicycle. Also, be sure to retighten the crank arm and pedals at periodic intervals.
- Use a neutral detergent to clean the crank arms and the bottom bracket. Using alkaline or acidic detergents may cause discoloration.
- If pedaling performance does not feel normal due to an abnormal noise, etc., contact your place of purchase.
- Do not wash the surrounding area of the bottom bracket with a high-pressure wash. Water may enter the bearing section and cause noise or adhesion.
- If you feel any excess play in the bearing section, the bottom bracket should be replaced.
- The chainrings should be periodically washed with a neutral detergent. In addition, cleaning the chain with neutral detergent and lubricating it can be an effective way of extending the life of the chainrings and the chain.
- The cuffs of your clothing may get dirty from the chain while riding.
- This product is not warranted against damage caused by improper use, abuse, or issues resulting from a crash, unless the circumstance was caused by a manufacturing problem.
- Products are not guaranteed against natural wear and deterioration from normal use and aging.
- For maximum performance we highly recommend SHIMANO lubricants and maintenance products.

For installation to the bicycle and maintenance

- When installing the pedals, apply a small amount of grease to the threads to prevent the pedals from seizing. Use a torque wrench to securely tighten the pedals. Tightening torque is 35 - 55 N·m. The right crank arm has a right-hand thread, and the left crank arm has a left-hand thread.
- If the bottom bracket shell is not parallel, gear shifting performance will drop.
- If the chain keeps coming off the gears during use, replace the chainrings and the chain.
- When installing the left- and right-hand cups, apply grease and be sure to install the inner cover. Otherwise,

TO ENSURE SAFETY

the waterproofing performance will worsen.

- To ensure the best performance, be sure to use only the specified type of chain.

Crankset	Recommended chain
FC-R9200	CN-M9100
FC-R8100	CN-M8100
FC-R7100 / FC-RS520	CN-M7100

- If a squeaking noise is heard coming from the bottom bracket axle and the left crank arm connector, apply grease to the fastening section, then tighten it to the specified torque.
- Only use chainring combinations listed below. If other chainring combinations are used, it can create poor shifting and cause the chain to jam, resulting in damage to the bicycle.

FC-R9200		Top		
		54T-NJ	52T-NH	50T-NK
Low	40T-NJ	X	-	-
	36T-NH	-	X	-
	34T-NK	-	-	X





FC-R8100 / FC-R7100		Top	
		52T-NH	50T-NK
Low	36T-NH	X	-
	34T-NK	-	X

FC-RS520		Top
		50T-NK
Low	34T-NK	X



The actual product may differ from the illustration because this manual is intended mainly to explain the procedures for using the product.

List of tools to be used

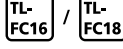

The following tools are needed for installation, adjustment, and maintenance purposes.

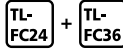
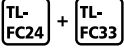
Tool			
	5 mm hexagon wrench		Soft face mallet
	8 mm hexagon wrench		Hexalobular [#30]
	17 mm spanner		TL-FC16 / TL-FC18

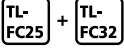
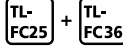
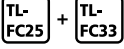

BB-R9100

Tool			
	TL-FC24 & TL-FC32		TL-FC24 & TL-FC36
	TL-FC24 & TL-FC33		TL-FC34

SM-BBR60

Tool			
	TL-FC25 & TL-FC32		TL-FC25 & TL-FC36
	TL-FC25 & TL-FC33		TL-FC37

BB-RS501 / BB-RS500

Tool			
	TL-FC32		TL-FC36
	TL-FC33		

SM-BB92-41B / SM-BB72-41B / BB-RS500-PB

Tool			
	TL-BB12		TL-BB13

Installation/removal

Installing/removing the bottom bracket

Tool combination chart

The tools required for installing and removing the bottom bracket differ by model. Combine and use any of the tools specified in the table.

BB-R9100

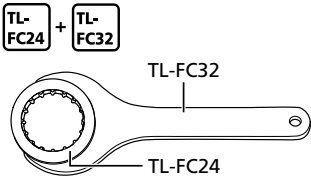
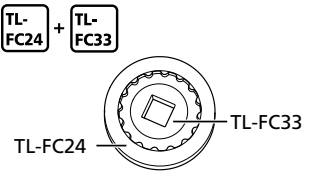
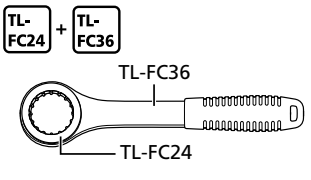
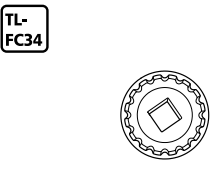

TL-FC24 & TL-FC32	TL-FC24 & TL-FC33
 <p>TL-FC24 + TL-FC32</p> <p>TL-FC32</p> <p>TL-FC24</p>	 <p>TL-FC24 + TL-FC33</p> <p>TL-FC24</p> <p>TL-FC33</p>
TL-FC24 & TL-FC36	TL-FC34
 <p>TL-FC24 + TL-FC36</p> <p>TL-FC36</p> <p>TL-FC24</p>	 <p>TL-FC34</p>

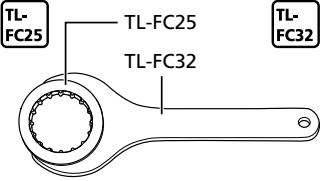
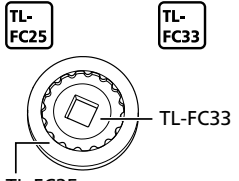
SM-BBR60

TL-FC25 & TL-FC32	TL-FC25 & TL-FC33
 <p>TL-FC25 + TL-FC32</p> <p>TL-FC25</p> <p>TL-FC32</p>	 <p>TL-FC25 + TL-FC33</p> <p>TL-FC25</p> <p>TL-FC33</p>

Installation/removal

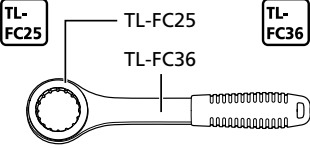
Installing/removing the bottom bracket

TL-FC25 & TL-FC36	TL-FC37
 <p>Diagram showing two tools: TL-FC25 (a ring with a central hole) and TL-FC36 (a long handle with a serrated end). Labels TL-FC25 and TL-FC36 are in boxes. Lines connect the labels to the respective tools.</p>	 <p>Diagram showing a circular tool with a square hole in the center, labeled TL-FC37 in a box.</p>

BB-RS501 / BB-RS500

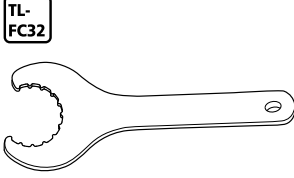
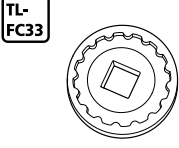
TL-FC32	TL-FC33
 <p>Diagram showing a tool with a curved, serrated head and a long handle, labeled TL-FC32 in a box.</p>	 <p>Diagram showing a circular tool with a square hole in the center, labeled TL-FC33 in a box.</p>

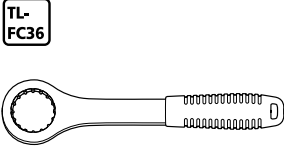
TL-FC36	
 <p>Diagram showing a tool with a ring head and a long handle with a serrated end, labeled TL-FC36 in a box.</p>	

NOTICE

- When using an impact wrench on BB-R9100, use it in combination with TL-FC34. Using any other combinations will damage the tool.
- When using an impact wrench on SM-BBR60, use it in combination with TL-FC37. Using any other combinations will damage the tool.
- TL-FC24 and TL-FC25 may become damaged and unusable after repeated use.
- When setting the TL-FC24 or TL-FC25 to the TL-FC32, refer to the markings on the TL-FC24 or TL-FC25 to check the possible installation positions.

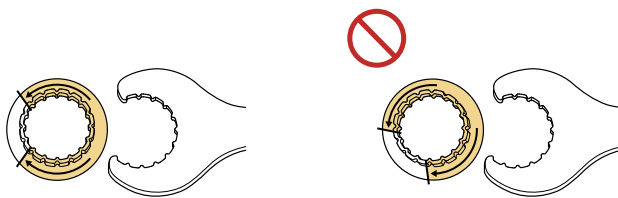

- Any installation position is possible for TL-FC33 and FC36.

Installation/removal

Installing/removing the bottom bracket

Installation

Threaded bottom bracket

1. Install the inner cover, cups, and spacers.

- (1) Apply grease to the left- and right-hand cups.
- (2) Use the SHIMANO original tools (refer to " Tool combination chart " in "Installing/removing the bottom bracket") to tighten the left- and right-hand cups.

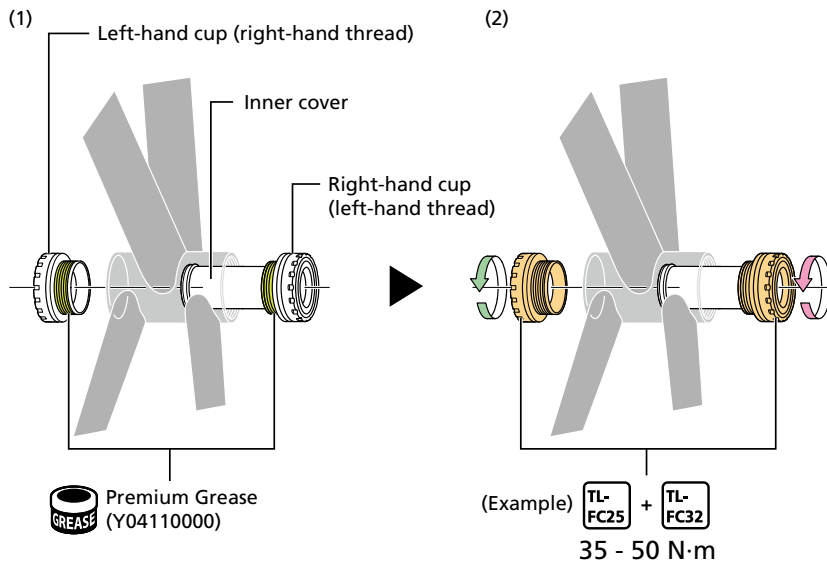

NOTICE

- If it is a 70 mm [M36] bottom bracket, turn the right-hand cup clockwise (right-hand thread).
- Make sure the electric wires exposed in the bottom bracket shell pass around the inner cover of the bottom bracket.

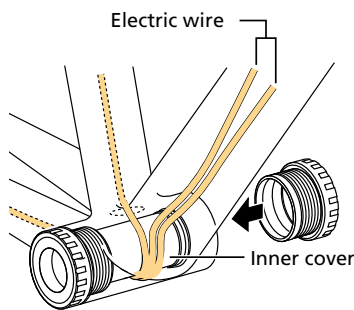

- If using a frame which does not have enough space between the inner wall of the bottom bracket shell and the inner cover to route the electric wires, use an inner cover which is sold separately.

Installation/removal

Installing/removing the bottom bracket

Press-fit bottom bracket

1. Set the bottom bracket in the bottom bracket shell.

- Use a bottom bracket compatible with a shell width of 86.5 mm.
- Set the inner cover and cups.

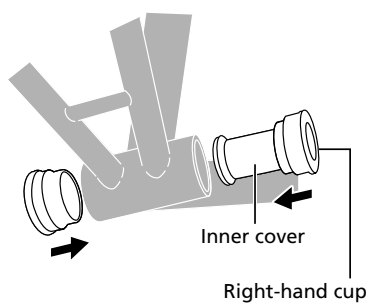
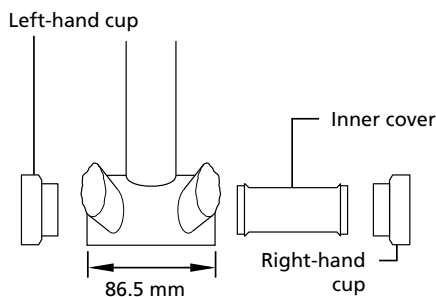

NOTICE

- If the frame has openings for the bottom bracket shell, attach an inner cover to prevent foreign objects from getting inside. If there are no openings, it can be installed without an inner cover.
- Make sure the electric wires exposed in the bottom bracket shell pass around the inner cover of the bottom bracket.

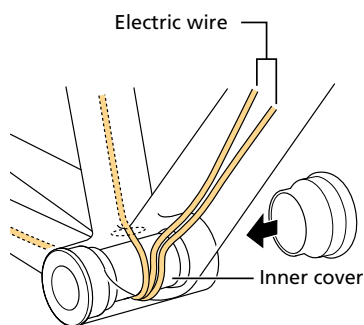

- If using a frame which does not have enough space between the inner wall of the bottom bracket shell and the inner cover to route the electric wires, use an inner cover which is sold separately.

Installation/removal

Installing/removing the bottom bracket

2. Insert the SHIMANO original tool into the bottom bracket.

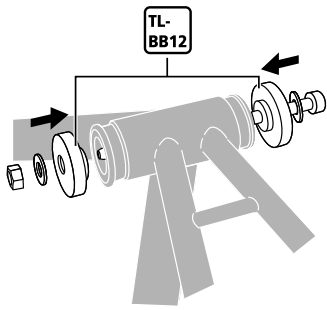

Installation/removal

Installing/removing the bottom bracket

3. Use the specified spanner and hexagon wrench to press-fit the bottom bracket.

Make sure that the contact surface of the bottom bracket is parallel with the contact surface of the bottom bracket shell.

* Press-fit until there is no more gap between the bottom bracket and the bottom bracket shell.

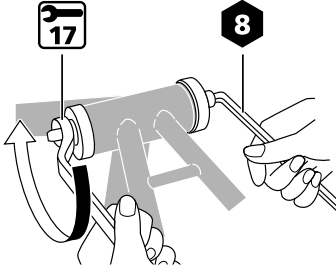

Removal

Threaded bottom bracket

1. Perform the removal in the reverse order from " Installation " in "Installing/removing the bottom bracket."

Press-fit bottom bracket

1. Insert the SHIMANO original tool into the bottom bracket.

- (1) Extend the flaps to taper the tip of the SHIMANO original tool.
- (2) Insert the SHIMANO original tool from the opposite side of the cup you wish to remove.
- (3) As shown in the figure, press down on the protruding portion of the tip with your hand to expand the flaps.
- (4) Push the tool in further while continuing to press down on the tip, until the collar on the flaps engages with the cup.

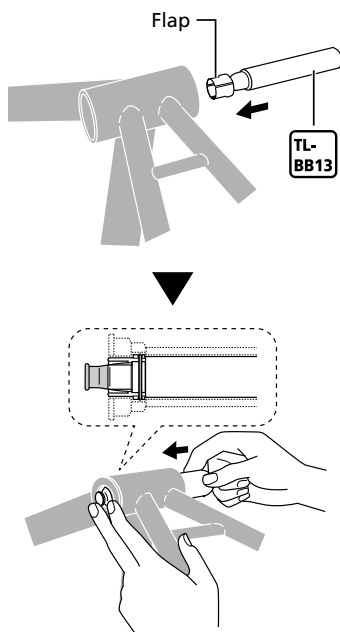

2. Tap the SHIMANO original tool with a soft face mallet to push out the cup.

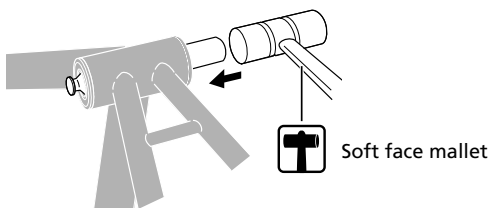

Installation/removal

Installing/removing the crankset

3. Remove the cup on the opposite side in a similar manner.

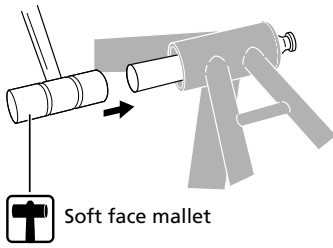

NOTICE

- Do not reuse the cups as they can be damaged during removal.

Installing/removing the crankset

Installation

1. Fully insert the right crank arm unit until it touches the bottom bracket.

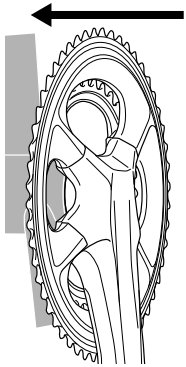

Installation/removal

Installing/removing the crankset

2. Set the left crank arm onto the axle of the right crank arm.

- (1) Apply grease to the axle of the right crank arm unit.
- (2) Align the wide section of the left crank arm spline with the wide section of the spline on the axle of the right crank arm unit.

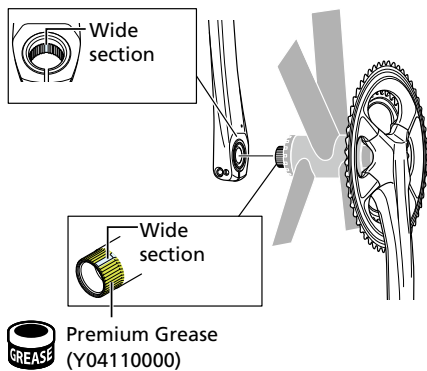

3. Install the cap.

- (1) Apply grease to the cap as specified in the figure.
- (2) Tighten using the SHIMANO original tool.

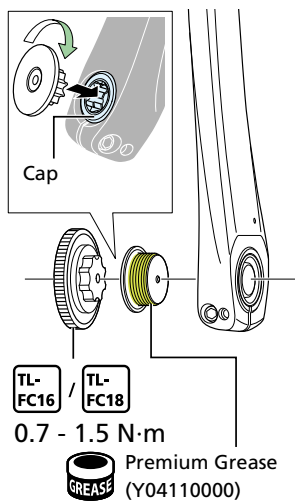

4. Tighten the mounting screws to secure the crank arm.

- (1) Set the stopper plate in the direction shown in the figure and push it in.
- (2) Check that the plate pin is securely inserted.
- (3) Tighten the left crank arm screws alternately until the two mounting screws reach the specified torque.

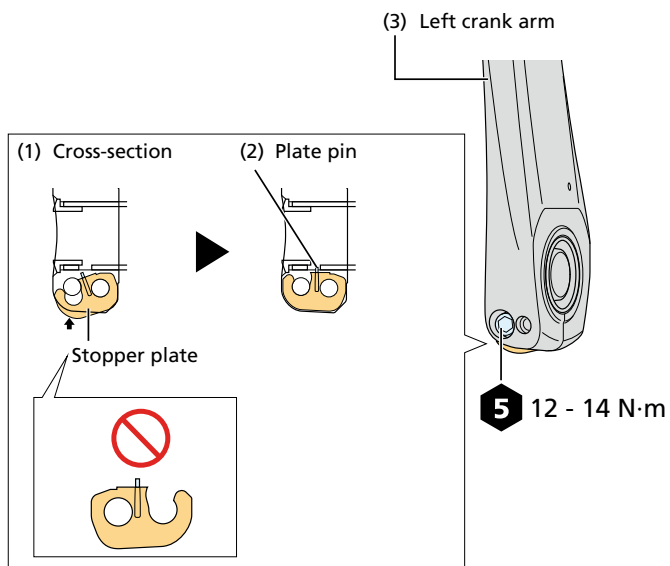

NOTICE

- The two mounting screws should be tightened alternately in stages rather than each screw being fully tightened at once.

Removal

1. Perform the removal in the reverse order from "Installation" in "Installing/removing the crankset."

Maintenance

Replacing the chainring

NOTICE

- Gear shifting performance will be reduced if the installation positions of the chainrings are incorrect. Be sure to install the chainrings in the correct positions.
- Make sure to use the correct combination of SHIMANO genuine parts, otherwise the crank arms or chainrings may become damaged.

Double chainring type

1. Remove the chainrings from the crank arm.
2. Set the largest chainring on the crank arm.

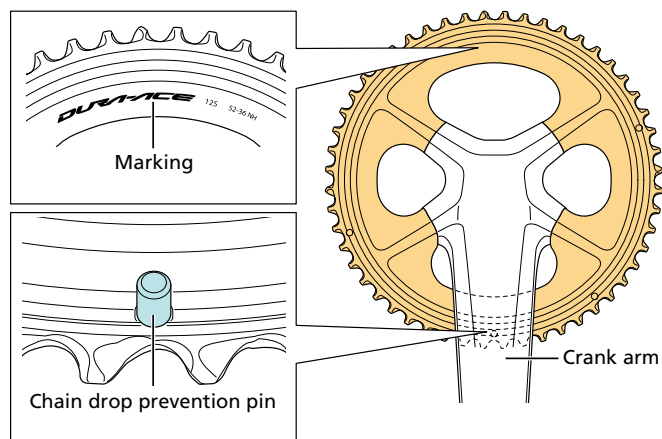

3. Install the smallest chainring.

- (1) With the marked side facing inward, set the smallest chainring so that the Δ marking or alignment tab is positioned under the crank arm.
- (2) Secure it using the chainring mounting screws.

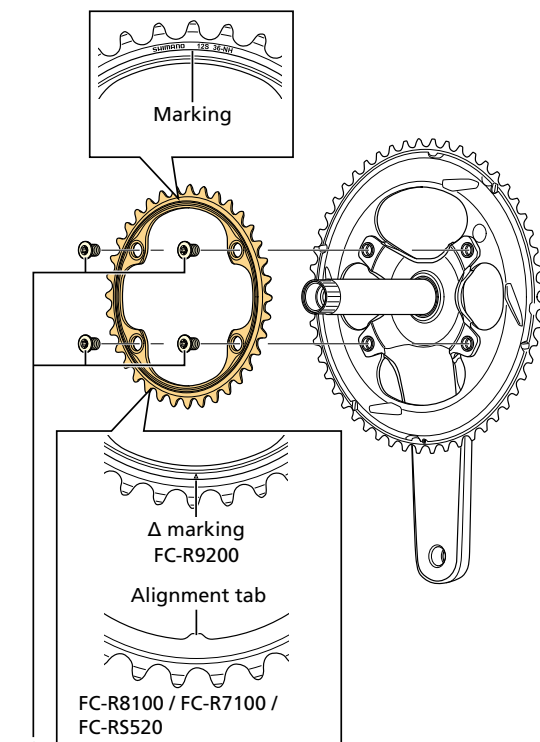

30 12 - 16 N·m
Chainring mounting screw

