

# Dealer's Manual

ROAD	GRAVEL	MTB
E-BIKE	LIFESTYLE	GENERAL

## Cassette

### **DURA-ACE**

CS-R9200-12

### **ULTEGRA**

CS-R8100-12

CS-R8101-12

### **SHIMANO 105**

CS-R7100-12

CS-R7101-12

### **SHIMANO**

CS-HG710-12

---

## Contents

<b>IMPORTANT NOTICE.....</b>	<b>3</b>
<b>TO ENSURE SAFETY.....</b>	<b>4</b>
<b>List of tools to be used .....</b>	<b>7</b>
<b>Installation / removal .....</b>	<b>8</b>
Installing the cassette .....	8
Removing the cassette.....	10
Sprocket pattern .....	11
<b>Maintenance.....</b>	<b>15</b>
Replacing the adhesive ring .....	15



# IMPORTANT NOTICE

- This dealer's manual is intended primarily for use by professional bicycle mechanics.  
Users who are not professionally trained for bicycle assembly should not attempt to install the components themselves using the dealer's manuals.  
If any part of the information on the manual is unclear to you, do not proceed with the installation. Instead, contact your place of purchase or a distributor for assistance.
- Make sure to read all manuals included with each product.
- Do not disassemble or modify the product other than as stated in the information contained in this dealer's manual.
- All manuals and technical documents are accessible online at <https://si.shimano.com> .
- For consumers who do not have easy access to the internet, please contact a SHIMANO distributor or any of the SHIMANO offices to obtain a hardcopy of the user's manual.
- Please observe the appropriate rules and regulations of the country, state or region in which you conduct your business as a dealer.

**For safety, be sure to read this dealer's manual thoroughly before use, and follow it for correct use.**

The following instructions must be observed at all times in order to prevent personal injury and physical damage to equipment and surroundings.

The instructions are classified according to the degree of danger or damage which may occur if the product is used incorrectly.

 <b>DANGER</b>	Failure to follow the instructions will result in death or serious injury.
 <b>WARNING</b>	Failure to follow the instructions could result in death or serious injury.
 <b>CAUTION</b>	Failure to follow the instructions could cause personal injury or physical damage to equipment and surroundings.

# TO ENSURE SAFETY

## **⚠ WARNING**

- Be sure to follow the instructions provided in the manuals when installing the product.  
Only use SHIMANO genuine parts. If a component or replacement part is incorrectly assembled or adjusted, it can lead to component failure and cause the rider to lose control and crash.
-  Wear approved eye protection while performing maintenance tasks such as replacing components.

### Be sure to also inform users of the following:

- Clean the chain and QUICK-LINK with an appropriate chain cleaner regularly. Intervals between maintenance depend on the use and riding circumstances. Never use alkali- or acid-based solvents such as rust cleaners. If those solvents are used the chain or QUICK-LINK might break and cause serious injury.

### For installation to the bicycle and maintenance

- Install the sprockets with the wide sections (protrusions and grooves) aligned. If the lock ring is tightened with the sprockets improperly positioned, the splines on the sprockets may be damaged during tightening. That may cause a sudden release of resistance on the wrench being used to tighten the lock ring, which in turn may cause injury. In addition, if the bicycle is ridden with the sprockets improperly installed, damage or chain skip may occur, which can cause the rider to fall over, resulting in serious injury.

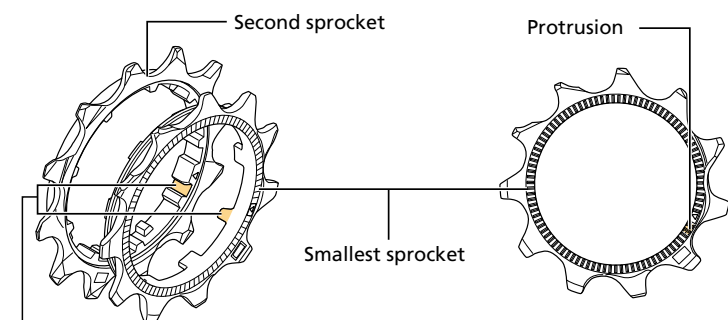

Align the protrusion with the groove.

Properly positioned state

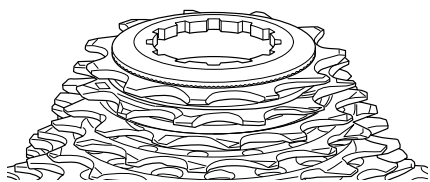

The protrusions on the smallest sprocket fit into the indents in the second sprocket along the entire circumference.

Improperly positioned state

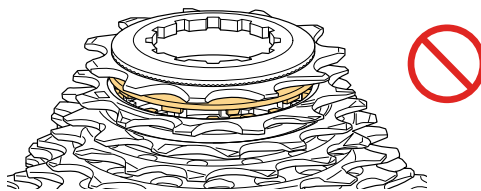

There are places where the protrusions on the smallest sprocket overlap the indents in the second sprocket.

- When removing the lock ring, wear gloves and the required protective gear, and gradually apply force. A sudden release of resistance on the lock ring may cause serious injury.

## **NOTICE**

Be sure to also inform users of the following:

- If the chain keeps skipping during use, consult the place of purchase.
- Products are not guaranteed against natural wear and deterioration from normal use and aging.
- For maximum performance we highly recommend SHIMANO lubricants and maintenance products.

For installation to the bicycle and maintenance



- The sprockets should be periodically washed with a neutral detergent then lubricated. In addition, cleaning the chain and QUICK-LINK with a neutral detergent and lubricating them can be an effective way of extending the life of the chain and QUICK-LINK.
- Always use the recommended combination of sprockets.
- Always use the CS-R9200 / CS-R8101 / CS-R8100 / CS-R7101 / CS-R7100 / CS-HG710 in combination with the CN-M9100 / CN-M8100 / CN-M7100 / CN-M6100.  
Other chains cannot be used because the dimensions do not match.

The actual product may differ from the illustration because this manual is intended mainly to explain the procedures for using the product.

---

# List of tools to be used

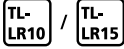
The following tools are needed for installation/removal, adjustment, and maintenance purposes.

Tool	
 TL-LR10 / TL-LR15	TL-LR10 / TL-LR15
 TL-SR24	TL-SR24
	Adjustable wrench

# Installation / removal

## Installing the cassette

1. **Place all of the sprockets other than the smallest sprocket on the freewheel body unit.**

Place the sprockets in descending order from the largest sprocket.

Place the sprockets so that the wide convex section of the sprockets are aligned with the wide groove section of the freewheel body unit.

The marked side of the sprockets must be facing outward.

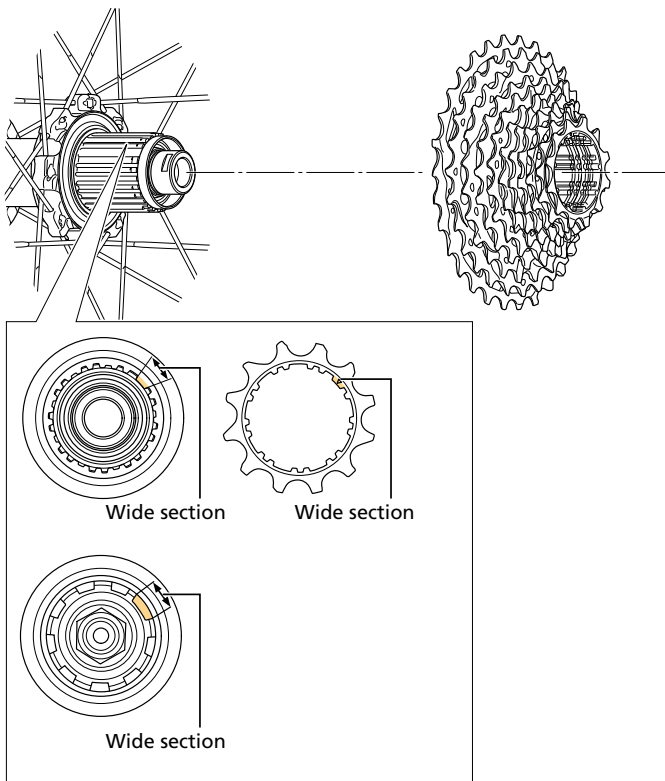



**2. Place the smallest sprocket.**

Place the sprocket so that the protrusion on the inner side of the smallest sprocket is aligned with the groove next to the wide section of the second sprocket.

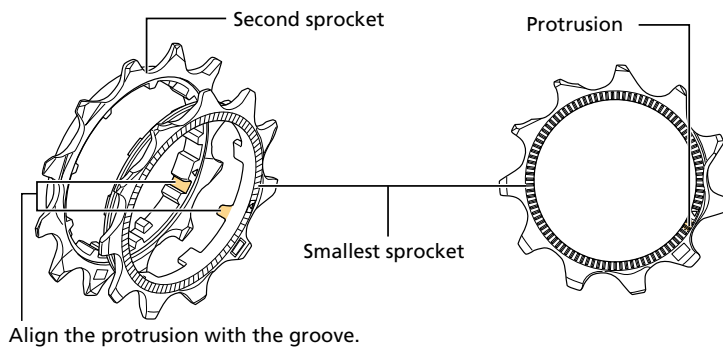

**TECH TIPS**

- All the sprockets have alignment marks, with the exception of the sprocket mounted on the spider arms. Assemble so that the marks of each sprocket are aligned.

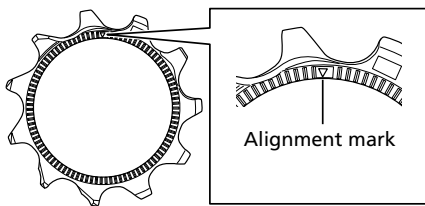

- If the sprocket alignment marks are properly placed, they will be as shown in the figure.

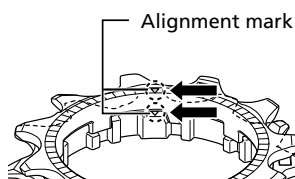

3. Place the lock ring into the freehub body and tighten the lock ring.

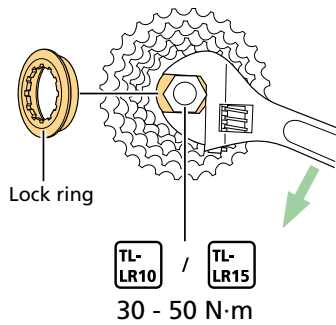

## Removing the cassette

1. Remove the lock ring.

Install TL-SR24 on the sprocket outward from the middle sprocket to secure the assembly. If the TL-SR24 is set on a sprocket inward from the middle sprocket, it will not be stable.

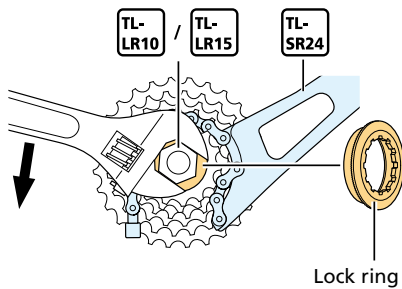

### **⚠ WARNING**

- When removing the lock ring, wear gloves and the required protective gear, and gradually apply force. A sudden release of resistance on the lock ring may cause serious injury.

2. Remove the cassette from the freehub body.

# Sprocket pattern

## CS-R9200

The thickness of the two sprocket spacers differs. Be careful when installing the sprocket spacers.

### 11-34T

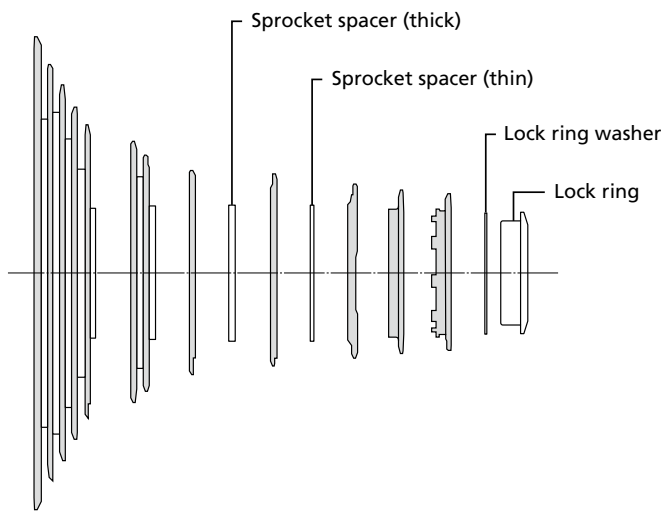

### 11-30T

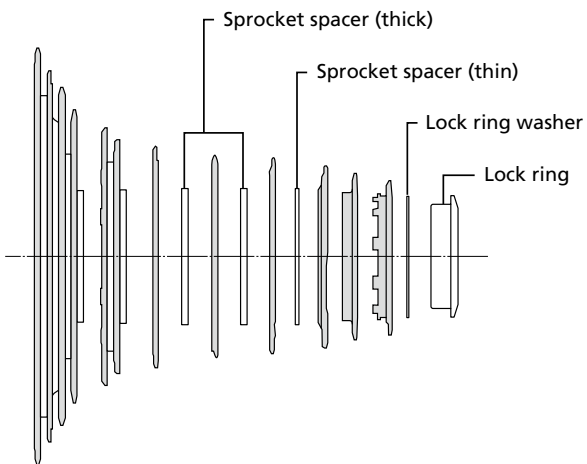

# Installation / removal

## Sprocket pattern

11-34T	11 - 12 - 13 - 14 - 15 - 17 - 19 - 21 - 24 - 27 - 30 - 34	T
Marking	C E D D D J J P E F D B	
11-30T	11 - 12 - 13 - 14 - 15 - 16 - 17 - 19 - 21 - 24 - 27 - 30	T
Marking	C E D D D E H J P E F C	

## CS-R8101 / CS-R8100

The thickness of the two sprocket spacers differs. Be careful when installing the sprocket spacers.

### 11-34T

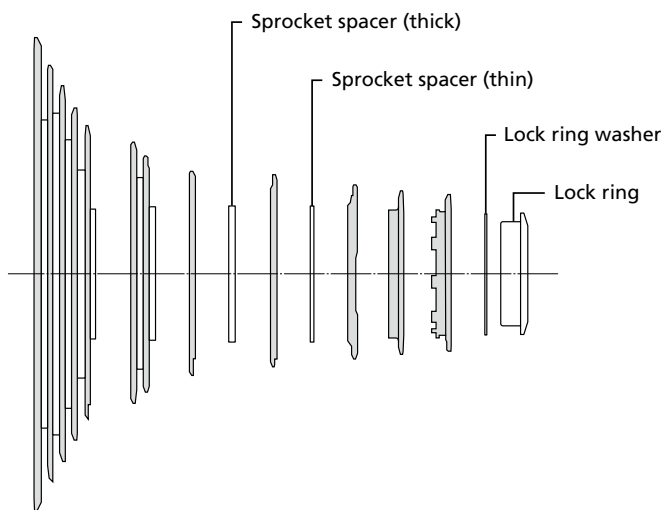

### 11-30T

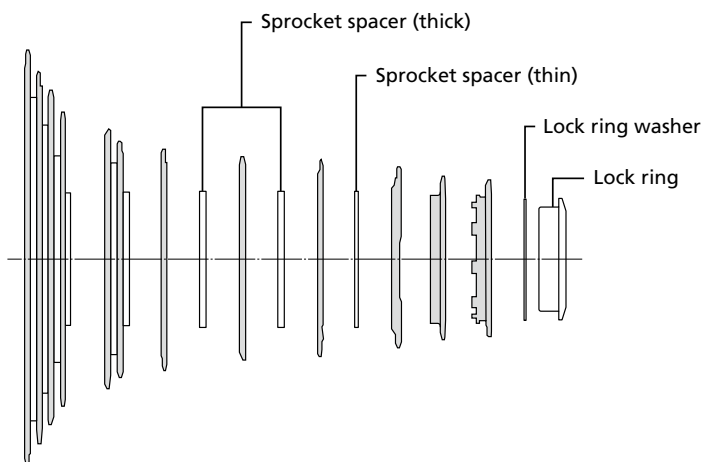

# Installation / removal

## Sprocket pattern

11-34T Marking	11 - 12 - 13 - 14 - 15 - 17 - 19 - 21 - 24 - 27 - 30 - 34	T
	C E D D D J L R F G E C	
11-30T Marking	11 - 12 - 13 - 14 - 15 - 16 - 17 - 19 - 21 - 24 - 27 - 30	T
	C E D D D E H L R F G E	

\* CS-R8100 is compatible with Di2 only

## CS-R7101 / CS-R7100

The thickness of the two sprocket spacers differs. Be careful when installing the sprocket spacers.

### 11-34T

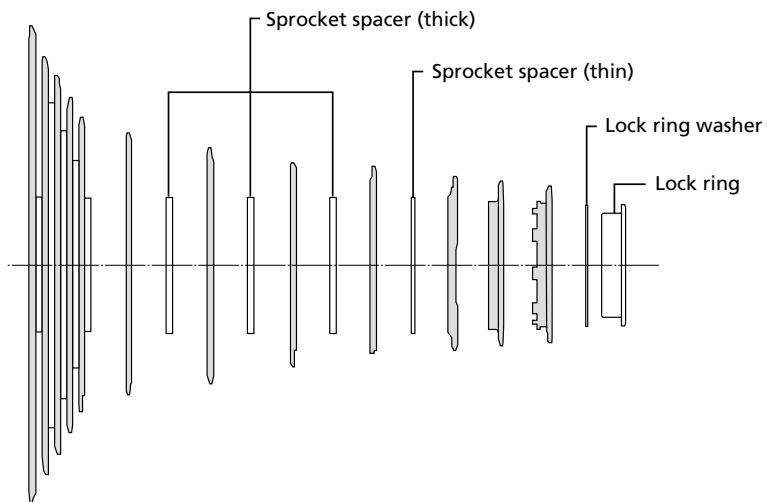

11-34T Marking	11 - 12 - 13 - 14 - 15 - 17 - 19 - 21 - 24 - 27 - 30 - 34	T
	C E D D D L N R F G E C	

# Installation / removal

## Sprocket pattern

---

\* CS-R7100 is compatible with Di2 only

### CS-HG710

The thickness of the two sprocket spacers differs. Be careful when installing the sprocket spacers.

#### 11-36T

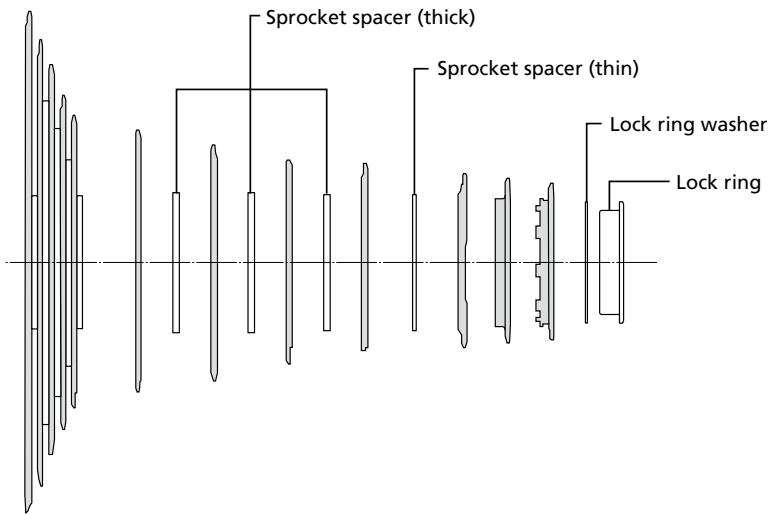

11-36T	11 - 12 - 13 - 14 - 15 - 17 - 19 - 21 - 24 - 28 - 32 - 36	T
Marking	C E D D D L N R F F E C	

# Maintenance

## Replacing the adhesive ring

1. Remove the old adhesive ring.

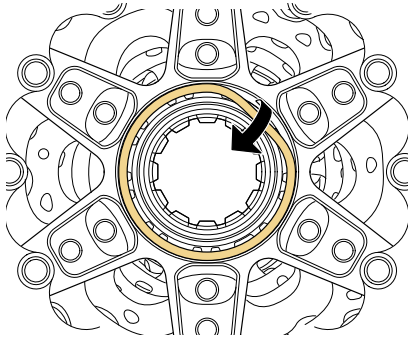

2. Wipe clean any dirt, water, and oil on the surface where the adhesive ring was affixed.

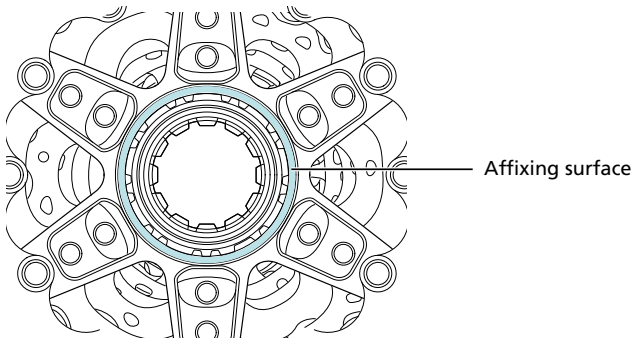

### **NOTICE**

- The adhesive force weakens if there is any dirt, water or oil on the surface where the adhesive ring is applied.

## Maintenance

### Replacing the adhesive ring

---

#### 3. Affix a new adhesive ring.

Firmly press down on the adhesive ring so that it adheres firmly to the mating face of the cassette.

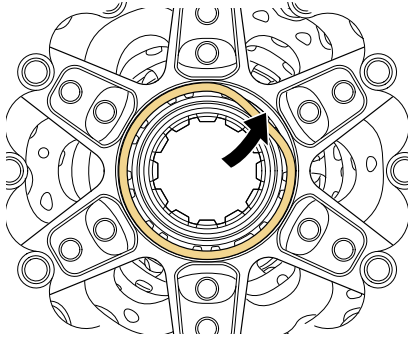



---

# SHIMANO

**SHIMANO NORTH AMERICA BICYCLE, INC.**  
One Holland, Irvine, California 92618, U.S.A. Phone: +1-949-951-5003

**SHIMANO EUROPE B.V.**  
High Tech Campus 92, 5656 AG Eindhoven, The Netherlands Phone: +31-402-612222

**SHIMANO INC.**  
3-77 Oimatsu-cho, Sakai-ku, Sakai City, Osaka 590-8577, Japan

Please note: specifications are subject to change for improvement without notice. (English)  
© Jul. 2023 by SHIMANO INC. ITP