

## Dealer's Manual

ROAD	<b>GRAVEL</b>	MTB
E-BIKE	LIFESTYLE	GENERAL

# Hydraulic Disc Brake/ Dual Control Lever (Di2)

**GRX**  
ST-RX825  
BL-RX825

---

## Contents

<b>IMPORTANT NOTICE</b>	<b>3</b>
<b>TO ENSURE SAFETY</b>	<b>4</b>
<b>List of tools to be used</b>	<b>10</b>
<b>Installation / removal</b>	<b>11</b>
Installing the rotor	11
Installing the dual control lever / brake lever	12
Installing the sub brake lever	15
Installing satellite shifters	16
Installing the brake hose (easy hose joint system)	17
• Overview of the easy hose joint system	17
• Checking the length of the hose	17
• Cutting the hose	18
• Connecting the hose	21
Installing the brake hose	24
• Connecting the hose	24
Installing the brake calipers	28
<b>Adjustment</b>	<b>29</b>
Adjusting the reach	29
Adjusting the free stroke	30
<b>Maintenance</b>	<b>32</b>
Replacing the pads	32
SHIMANO genuine mineral oil replacement	33
• Draining the mineral oil	33
• Adding mineral oil and bleeding air	35
Caliper piston maintenance	43
Replacing the bracket cover	44
Replacing the coin batteries of the dual control levers	45
• Before replacing the coin batteries	45
• Checking the dual control lever battery level	45
• Replacing the coin batteries	46

# IMPORTANT NOTICE

- **This dealer's manual is intended primarily for use by professional bicycle mechanics.**

Users who are not professionally trained for bicycle assembly should not attempt to install the components themselves using the dealer's manuals.



If any part of the information on the manual is unclear to you, do not proceed with the installation. Instead, contact your place of purchase or a distributor for assistance.

- Make sure to read all manuals included with each product.
- Do not disassemble or modify the product other than as stated in the information contained in this dealer's manual.
- All manuals and technical documents are accessible online at <https://si.shimano.com>.
- For consumers who do not have easy access to the internet, please contact a SHIMANO distributor or any of the SHIMANO offices to obtain a hardcopy of the user's manual.
- Please observe the appropriate rules and regulations of the country, state or region in which you conduct your business as a dealer.

**For safety, be sure to read this dealer's manual thoroughly before use, and follow it for correct use.**

The following instructions must be observed at all times in order to prevent personal injury and physical damage to equipment and surroundings.

The instructions are classified according to the degree of danger or damage which may occur if the product is used incorrectly.

 <b>DANGER</b>	Failure to follow the instructions will result in death or serious injury.
 <b>WARNING</b>	Failure to follow the instructions could result in death or serious injury.
 <b>CAUTION</b>	Failure to follow the instructions could cause personal injury or physical damage to equipment and surroundings.

# TO ENSURE SAFETY

## ⚠ WARNING

- **Be sure to follow the instructions provided in the manuals when installing the product.**  
Only use SHIMANO genuine parts. If a component or replacement part is incorrectly assembled or adjusted, it can lead to component failure and cause the rider to lose control and crash.
-  Wear approved eye protection while performing maintenance tasks such as replacing components.

Be sure to also inform users of the following:

- Because each bicycle may handle slightly differently depending on the model, be sure to learn the proper braking technique (including brake lever pressure and bicycle control characteristics) and operation of your bicycle. Improper use of your bicycle's brake system may result in a loss of control, which could lead to serious injury due to a fall or collision.
- Keep your fingers away from the rotating rotor. The rotor is sharp enough to inflict severe injury to your fingers if caught.



- Do not touch the calipers or rotor while riding or immediately after dismounting from the bicycle. The calipers and rotor will become hot when the brakes are operated, so you may get burned if you touch them.
- Do not allow any oil or grease to get onto the rotor or pads. Riding the bicycle with oil or grease on the rotor or pads may prevent the brakes from operating and result in serious injury due to a fall or collision.
- Check the thickness of the pads and do not use them if they have a thickness of 0.5 mm or less. Doing so may prevent the brakes from operating and result in serious injury due to a fall or collision.

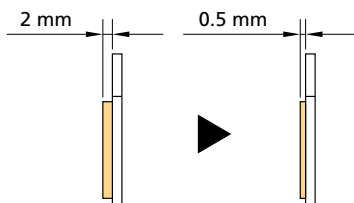

- Do not use the rotor if it is cracked or deformed. The rotor may break, and result in serious injury due to a fall or collision.
- Do not use the rotor if its thickness is 1.5 mm or less. Also do not use it if the aluminum surface becomes visible. The rotor may break, and result in serious injury due to a fall or collision.
- Do not continuously apply the brakes. Doing so may cause a sudden increase in the brake lever stroke, preventing the brakes from operating and resulting in serious injury due to a fall or collision.
- Do not use the brakes with fluid leaking. Doing so may prevent the brakes from operating and result in serious injury due to a fall or collision.
- Do not apply the front brake too strongly. If you do so, the front wheel may lock and the bicycle may fall forward, and serious injury may result.
- Because the required braking distance will be longer during wet weather, reduce your speed and apply the brakes early and gently. You may fall or collide and be seriously injured.
- A wet road surface may cause tires to lose traction; therefore, to avoid this, reduce your speed and apply the brakes early and gently. If the tires lose traction, it may result in serious injury due to a fall or collision.

- If the quick release lever is on the same side as the rotor, confirm that it does not interfere with the rotor. Otherwise, the bicycle may fall forward, and serious injury may result.
- **Dual control lever**
  - Do not throw or subject this product to strong shocks. If this is not observed, bursting, overheating or problems with operation may occur.
  - Do not let grease adhere to the metal terminals. A conduction failure may result.
  - Use only the coin batteries specified. When replacing the coin battery, replace both batteries at the same time with new ones. Using different kinds of coin batteries or new and old coin batteries together may cause the coin batteries to burst, leak fluid, overheat or catch fire, resulting in a fire, injuries or contamination in the surrounding area.
  - Keep the coin batteries out of the reach of children and do not use this equipment in locations where children are likely to be present. If batteries are swallowed by mistake, seek medical attention immediately.
  - Dispose of the coin batteries according to proper country and/or state disposal regulations. Disposal of this product into fire or a hot oven, or mechanically crushing or cutting it, can result in an explosion of the coin batteries.
  - Do not use the coin batteries outside their operating temperature ranges. If a battery is used or stored in temperatures which are outside these ranges, fire, injury or problems with operation may occur.
  - Do not use the coin batteries if leakages, discoloration, deformation or any other abnormalities occur. If this is not observed, bursting, overheating or problems with operation may occur.
  - If any leaked fluid from the coin batteries gets on your skin or clothes, wash it off immediately with clean water. The leaked fluid may damage your skin.
  - Do not leave this product in an extremely high temperature surrounding environment such as in a closed vehicle on a hot day, or near a heater. Doing so may result in an explosion of the coin batteries or the leakage of flammable liquid or gas from them.
  - Do not subject this product to extremely low air pressure. Doing so may result in an explosion of the coin batteries or the leakage of flammable liquid or gas from them. Transporting this product by air is not a problem.
  - When operating the shift switch, be careful not to allow your fingers to be caught in the derailleur. The motor in the derailleur is powerful enough to be operated without stopping until the shifting position is reached, and may cause serious injury if your fingers interfere with the shifting motion.

### For installation to the bicycle and maintenance

- Do not use oil other than SHIMANO genuine mineral oil. Doing so may prevent the brakes from operating and result in serious injury due to a fall or collision.
- Use only mineral oil from a container that has been stored in a clean and sealed state. Doing otherwise may prevent the brakes from operating and result in serious injury due to a fall or collision.
- Do not let water or air bubbles get into the brake system. Doing so may prevent the brakes from operating and result in serious injury due to a fall or collision.
- Do not use with a tandem bicycle. Doing so may prevent the brakes from operating and result in serious injury due to a fall or collision.

## TO ENSURE SAFETY

- When installing the brake caliper using screw fixing pins, be sure to use caliper fixing screws of the appropriate length.

Failing to install caliper fixing screws of the correct length may cause the screws to fall out or lead to insufficient force for holding the brake caliper.

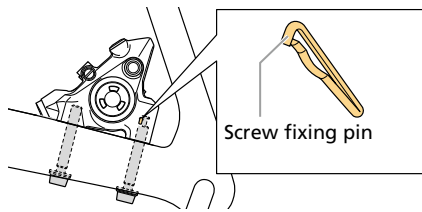

### ■ Brake hose

- Refer to the table below, and do not use an incorrect connector insert. Doing so may prevent the brakes from operating and result in serious injury due to a fall or collision.

Brake hose	Connector insert	
	Length	Color
SM-BH90-JK-SSR	11.2 mm	Silver

- Do not reuse the olive piece or the connector insert when reinstalling. Doing so may prevent the brakes from operating and result in serious injury due to a fall or collision.

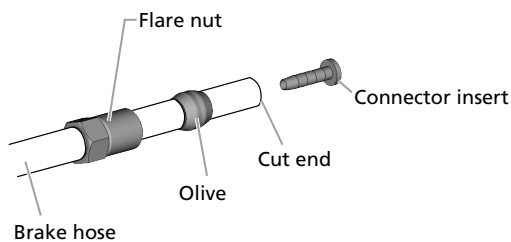

- Cut the brake hose so that the cut end is perpendicular to the length of the hose. If the brake hose is cut at an angle, fluid leaks may result. Fluid leaks may prevent the brakes from operating and result in serious injury due to a fall or collision.



### ■ When using TL-BH62

- Read the TL-BH62 manual carefully, and keep it in a safe place for later reference.

## ⚠ CAUTION

Be sure to also inform users of the following:

### ■ Cautions on SHIMANO genuine mineral oil

- Use appropriate eye protection when handling, and avoid contact with eyes. In the event of eye contact, flush with fresh water and seek medical assistance immediately. Contact with eyes may result in irritation.
- Use gloves when handling. In the event of skin contact, wash well with soapy water. Contact with skin may cause a rash and discomfort.
- Cover nose and mouth with a respirator type mask and use in a well ventilated area. Inhalation of mineral oil mist or vapors may cause nausea.
- If mineral oil mist or vapor is inhaled, go immediately to an area with fresh air. Cover up with a blanket. Stay warm and stable and seek professional medical advice.

### ■ Bed-in period

- Disc brakes have a bed-in period, and the braking force will gradually increase as the bed-in period progresses. You may lose control of the bicycle, which can result in serious injury due to a fall or collision.  
(The same thing will happen when the pads or rotor are replaced.)

### For installation to the bicycle and maintenance

- When using the SHIMANO original tool (TL-FC36, etc.) to remove and install the rotor lock ring, wear gloves and be careful not to touch the outer edges of the rotor with your hands. Failure to do so may result in cuts to your hands.
- ### ■ Handling SHIMANO genuine mineral oil
- Do not drink. May cause vomiting or diarrhea.
  - Keep out of reach of children.
  - Do not cut, let near heat, weld or pressurize the SHIMANO genuine mineral oil container. Doing so may cause an explosion or fire.
  - Disposal of used oil: Follow local county and/or state codes for disposal. Use caution when preparing the oil for disposal.
  - Directions: Keep the container sealed to prevent foreign objects and moisture from getting inside, and store it in a cool, dark area away from direct sunlight or heat. Keep from heat or flame.
  - For cleaning brake hoses exposed to mineral oil, or cleaning and maintaining tools, use isopropyl alcohol or a dry cloth. Do not use commercially available brake cleaners. Doing so may cause damage to plastic parts.
- ### ■ Brake hose
- When cutting the brake hose, handle the knife carefully so as not to cause injury.
  - Be careful to avoid injury from the olive.
- ### ■ When using TL-BH62
- When cutting the brake hose, handle the blade carefully so as not to cause injury.
  - Be careful to avoid pinching your fingers between the lever and the tool during operations.
  - When replacing the knife blade, handle the knife carefully so as not to cause injury.
  - Keep the tool and the blades out of reach of children.

## **NOTICE**

### Be sure to also inform users of the following:

- When the bicycle wheel has been removed, it is recommended that pad spacers are installed. Do not depress the brake lever while the wheel is removed. If the brake lever is depressed without the pad spacers installed, the pistons will protrude further than normal. If that happens, consult a place of purchase.
- When conducting maintenance, do not use commercially available brake cleaners or silencing agents, as they can cause damage to parts such as the seals.
- Be sure to keep rotating the crank arm during gear shifting operations.
- Handle the components carefully, and avoid subjecting them to strong shock.
- Do not use the thinners or harsh solvents to clean the products. Such solvents may damage the surface.
- If gear shifting operation does not feel smooth, consult the place of purchase for assistance.
- Be careful not to get water into the E-TUBE ports and the satellite shifter connection port.
- The components are designed to be fully waterproofed to withstand wet weather riding conditions; however, do not deliberately place them into water.

- Do not clean the bicycle with a high-pressure wash. If water gets into any of the components, operating problems or rusting may result.
- Contact the place of purchase for updates of the component firmware. The most up-to-date information is available on the SHIMANO website.
- Be sure to attach dummy plugs to any unused E-TUBE ports and the satellite shifter connection port. If water gets into any of the components, operating problems or rusting may result.
- The E-TUBE port and the satellite shifter connection port on BL-RX825 cannot be used. A dummy plug cannot be installed.
- The electric wire has small waterproof connectors, so do not repeatedly connect and disconnect it too often. Doing so may impair the waterproofing.
- 2.4 GHz digital wireless  
This product adopts digital communication technologies in the 2.4 GHz frequency, which are used for wireless LAN, etc.
- It may receive interference in the following locations or environments that prevent wireless communication from being performed correctly:
  - \* Near a device such as a television, computer, radio, motor, or microwave oven, or inside an automobile or railway car
  - \* Near a railway crossing or railway track, television transmitting station, or radar base, etc.
  - \* When using the device in combination with another cordless device or some lights
- Coin batteries
  - \* Insert the coin batteries with the correct +/- orientation.
  - \* Remove the coin batteries if you do not use them for a long period.
  - \* When the coin batteries are depleted, remove them immediately.
- Store this product or the bicycle with this product installed in a cool indoor location away from direct sunlight and rain (approx. 10 - 20°C).
- If the storage temperature is too low or too high, the performance of the coin batteries is reduced, and their usable time will be shorter.
- When using after a long period of non-use, be sure to replace the coin batteries with new ones.
- Products are not guaranteed against natural wear and deterioration from normal use and aging.
- For maximum performance we highly recommend SHIMANO lubricants and maintenance products.

### For installation to the bicycle and maintenance











- Use a brake hose/electric wire which still has some length to spare even when the handlebars are turned all the way to both sides. Furthermore, check that the dual control lever/brake lever does not touch the bicycle frame when the handlebars are turned all the way.
- Do not remove the lever unit from the bracket body.
- If the brake caliper mounting boss and the dropout are not of standard dimensions, the rotor and caliper may touch. If this occurs, contact the manufacturer of the bicycle frame or fork for assistance.
- When the bicycle wheel has been removed, it is recommended that pad spacers are installed. The pad spacers will prevent the piston from coming out if the brake lever is depressed while the wheel is removed.

- If the brake lever is depressed without the pad spacers installed, the pistons will protrude further than normal. Use a flat-shaped tool to push back the pads, while being careful not to damage the surface of the pads. (If the pads are not installed, use a flat-shaped tool to push the pistons straight back in, while being careful not to damage them.) When pushing back the pads or pistons, do so with an oil funnel attached to the brake lever. Otherwise, the diaphragm of the brake lever may be damaged by the oil pressure.
  - Do not remove the pistons when cleaning the calipers.
  - Use the parts indicated in the exploded view of the dual control lever/brake lever when you replace the clamp band, mounting screw, or mounting nut.
  - Even with the recommended tightening torque, there is a possibility that the carbon handlebars may become damaged and insufficiently tightened. Confirm the appropriate torque value with the bicycle manufacturer or the handlebar manufacturer.
- Dual control lever
- Dummy plugs are installed at the time of shipment from the factory. Do not remove them except when necessary.
  - When routing the electric wires, take care to ensure that they do not interfere with the brake levers.
- Satellite shifter
- When connecting electric wires, make sure that foreign matter does not get inside the plug or satellite shifter connection port. A connection with foreign matter present may result in a malfunction.
  - If the plug is exposed during storage, transportation, or maintenance work, and there is a possibility of foreign matter getting inside, protect the plug with masking tape or a similar material.
  - If you do not feel a click when connecting an electric wire, check that there is no foreign matter inside the plug or satellite shifter connection port. If foreign matter is present, use a blower to remove it. If the problem persists, replace the satellite shifter with a new one.
- Notes on reinstalling and replacing components
- Pairing is required after reinstalling or replacing the dual control levers or rear derailleur. Perform pairing with a wired or wireless connection.
  - If the component configuration changes or malfunction is observed, use E-TUBE PROJECT to update the firmware of each component to the latest version and perform a check again. Also, make sure that E-TUBE PROJECT is the latest version. If the software is not the latest version, the component compatibility or the product functions may not be available.

The actual product may differ from the illustration because this manual is intended mainly to explain the procedures for using the product.

# List of tools to be used

The following tools are needed for installation, adjustment, and maintenance purposes.

Tool	
	2 mm hexagon wrench
	2.5 mm hexagon wrench
	3 mm hexagon wrench
	5 mm hexagon wrench
	8 mm spanner
	Slotted screwdriver 0.8 x 4
	TL-BH62
	TL-BR001 (syringe and tube)
	TL-BR002 (oil funnel and oil stopper)
	Micrometer

# Installation / removal

## Installing the rotor

Refer to the [Dealer's Manual for the Wheels](#) to install and remove the rotor.

# Installing the dual control lever / brake lever

## NOTICE

- Wireless gear shifting requires the dual control levers to be paired with the rear derailleur. For information on pairing the components wirelessly with E-TUBE PROJECT, refer to the [E-TUBE PROJECT user's manual](#). For information on pairing the components via a wired connection, refer to the [dealer's manual for the rear derailleur \(Di2\)](#).

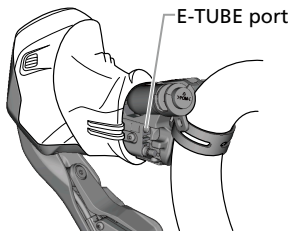

- The ST-RX825 is for wireless gear shifting only. It does not support wired gear shifting.
- If the firmware of the dual control lever is updated, pairing can be performed only with the dual control levers and the rear derailleur. For how to perform pairing and the compatible rear derailleur, refer to the [dealer's manual for the rear derailleur \(Di2\)](#).

## TECH TIPS

- PC linkage devices can be connected to the E-TUBE port when performing maintenance. However, leave the dummy plug attached to the unused E-TUBE port when a PC linkage device is not in use.

### 1. Turn over the bracket cover from the back side.

Gently turn over the ends of the bracket cover with both hands and slowly push them down.

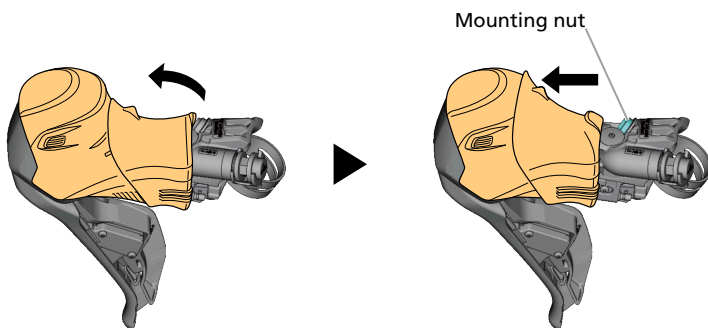

## NOTICE

- Forcibly pulling the bracket cover may damage it because of its material properties.

### 2. Loosen the mounting nut and pass the clamp band over the handlebar.

The mounting nut is found on top of the lever bracket when the bracket cover is turned over.

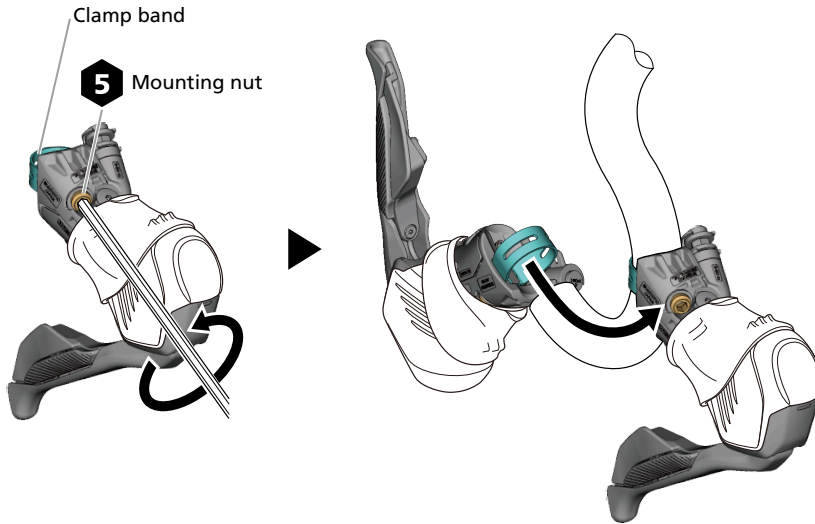

### NOTICE

- Be sure to loosen the mounting nut sufficiently. Otherwise the handlebar may be damaged when passing the clamp band over the drop handlebar.

### 3. Temporarily install the lever to the handlebar.

Temporarily install the lever so that it cannot move.

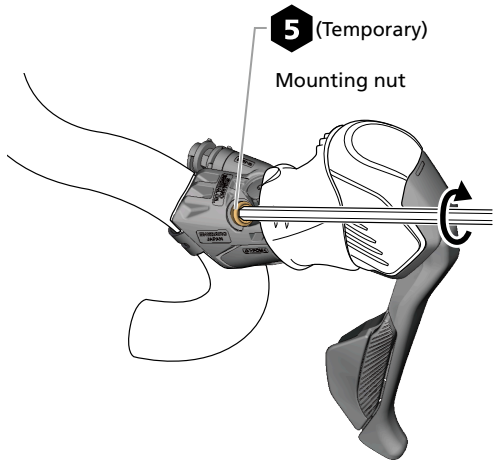

### NOTICE

- Use the parts indicated in the exploded view of the dual control lever/brake lever when you replace the clamp band, mounting screw, or mounting nut.

### 4. After installing and connecting brake hose and electric wire, check the connections.

### 5. Secure the dual control lever/brake lever to the handlebar.

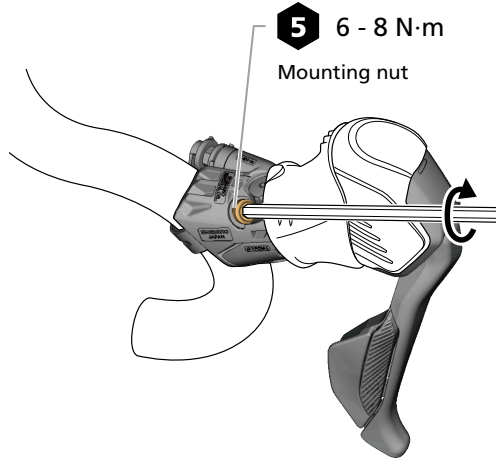

## Installing the sub brake lever

Refer to the [Gravel Hydraulic Disc Brake/Dual Control Lever Dealer's Manual](#) to install the sub brake lever.

# Installing satellite shifters

Refer to the [Road Hydraulic Disc Brake/Dual Control Lever \(Di2\) Dealer's Manual](#) to install the satellite shifter.

# Installing the brake hose (easy hose joint system)

## Overview of the easy hose joint system

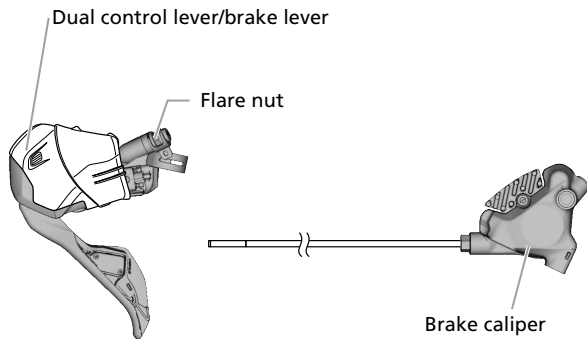

## Checking the length of the hose

### 1. Route the brake hose into the final installation position.

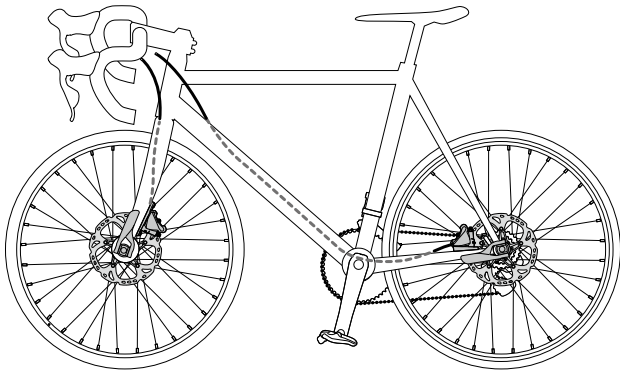

### **NOTICE**

- This figure is only for explanatory purposes. For details on how to route the brake hoses, consult the manufacturer of the bicycle or refer to the bicycle's manual.

### 2. Check the appropriate length of the brake hose.

Secure the lever in the position used when riding.

Check the mark on the brake hose with the edge of the brake lever flare nut.

- \* If the hose is at the appropriate length, it is not necessary to cut the hose. Proceed to "[Connecting the hose](#)" in "Installing the brake hose (easy hose joint system)."
- \* If the hose needs to be shortened, proceed to "[Cutting the hose](#)" in "Installing the brake hose (easy hose joint system)" to shorten the hose.
- \* If the hose length is insufficient, replace with a hose that has an appropriate length.

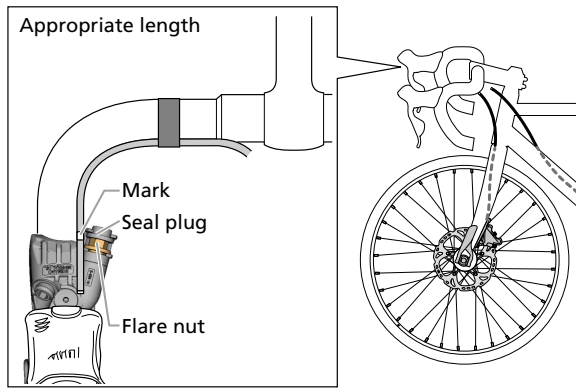

## Cutting the hose

Use care when cutting the hose, as oil may leak when the hose is cut.

### NOTICE

- Make sure to also refer to the manual for SHIMANO original tool TL-BH62.
- Do not move the lever indicated in the figure before disassembling SHIMANO original tool TL-BH62.

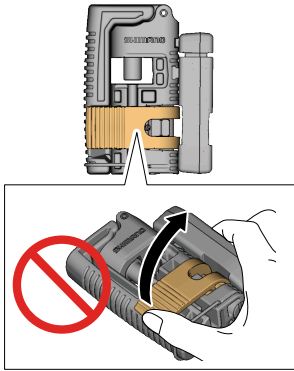

### 1. Determine the appropriate length and add a witness mark on the brake hose.

Add the mark so it is aligned with the edge of the flare nut.

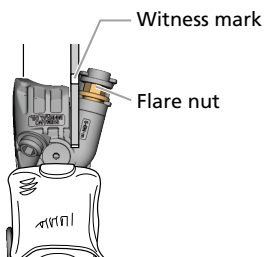

### 2. Add a cut mark.

Mark the hose at a position 21 mm from the witness mark towards the end of the hose.

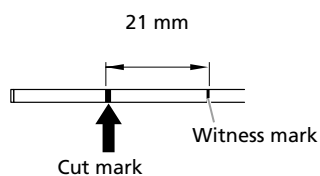

**3. Prepare tool TL-BH62 for the cutting of the brake hose.**

Disassemble the tool as shown in the figure.

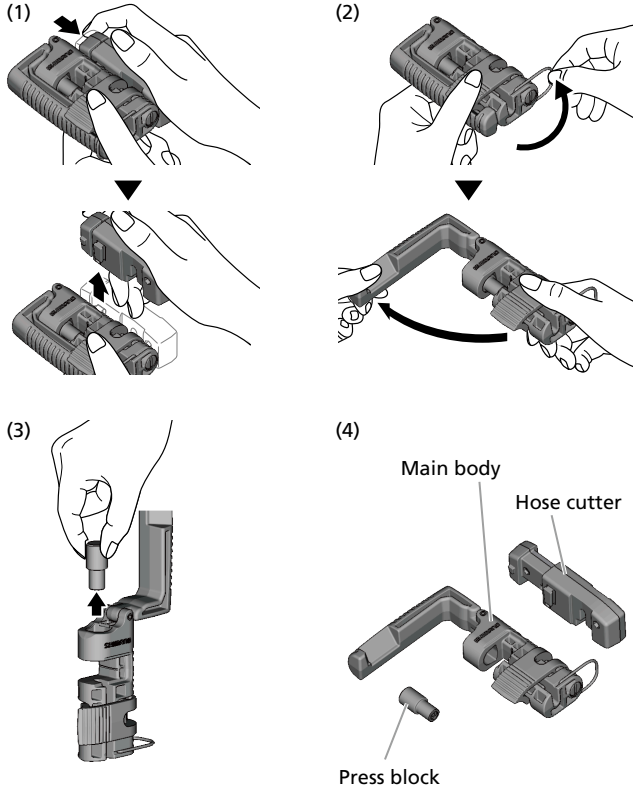

**4. Insert the brake hose into the TL-BH62.**

When placing the brake hose, make sure that the cut mark is parallel with the alignment groove in the tool.

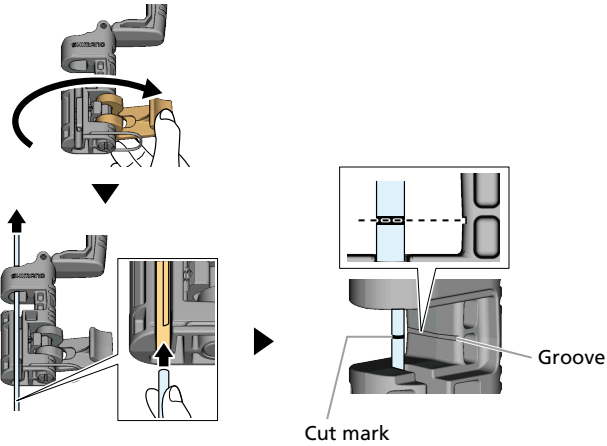

**5. Check the cut location and secure the brake hose in place.**

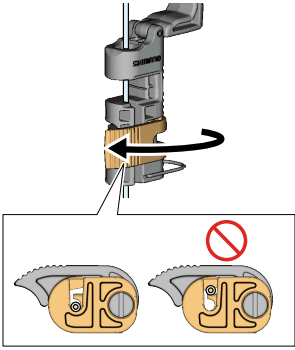

6. Check that the hose is secure, then install the hose cutter.

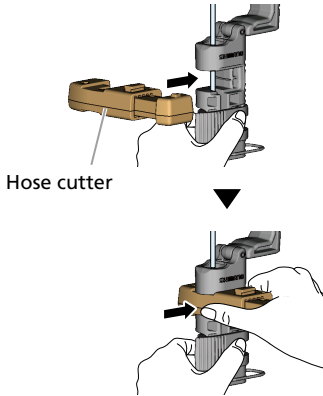

7. Press the hose cutter as shown in the figure to cut the brake hose.

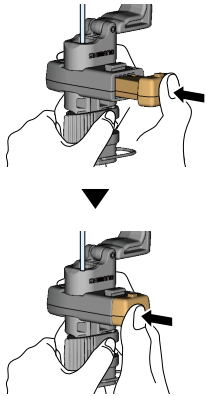

8. Remove the hose cutter and check that the cut end is even.

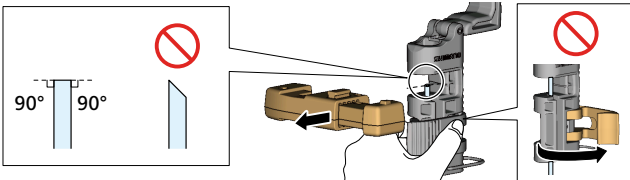

9. Install the connector insert in the press block, then set the press block in the TL-BH62.

Make sure that the tip of the connector insert is correctly positioned inside the opening of the brake hose.

## Installation / removal Installing the brake hose (easy hose joint system)

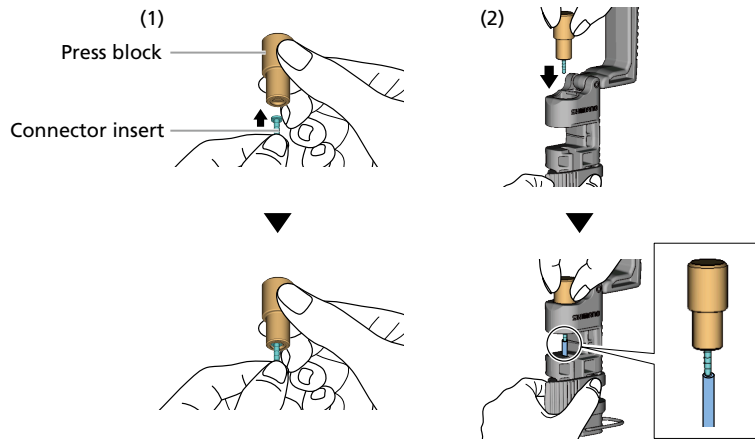

### NOTICE

- When connecting with an easy hose joint system, a specific Connector Insert (SHIMANO CODE No.: Y8JA98020/color: silver) must be used. Use of any connector insert other than the specified one may lead to oil leakage and other malfunctions.

#### 10. Depress the lever on the TL-BH62 to install the connector insert in the brake hose.

Check that the connector insert is installed correctly.

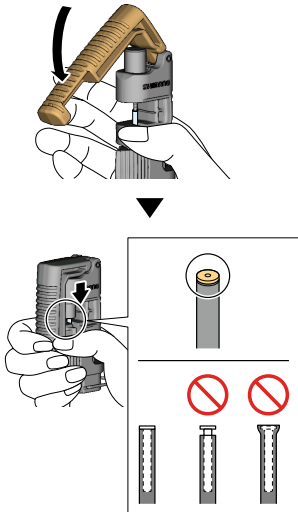

#### 11. Remove the brake hose from the TL-BH62.

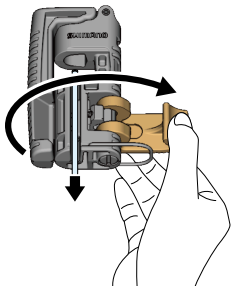

## Connecting the hose

#### 1. Secure the lever with the hose connector facing up by changing the angle of the handlebar, etc.

Perform this task with the brake caliper removed from the frame as needed.

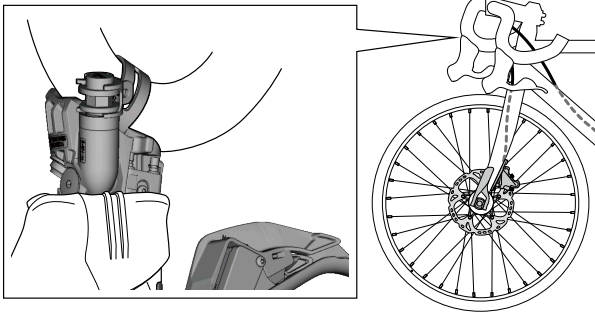

## NOTICE

- You may need to adjust the angle of the lever outward in order to gain clearance for the spanner. Be careful not to damage the handlebar and other parts when doing so.

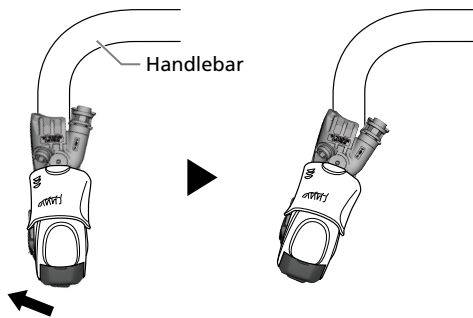

### 2. Remove the plug holder.

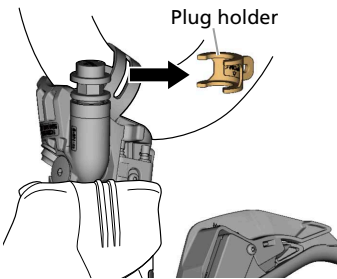

### 3. Remove the seal plug.

Use a clean rag to keep oil from dripping off the seal plug.

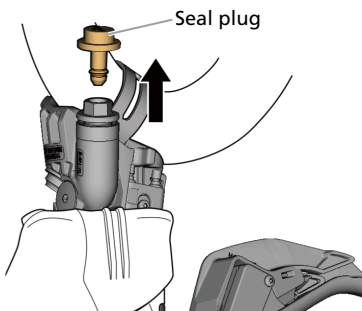

### 4. Insert the brake hose into the brake hose connection port.

The lever comes with a pre-installed olive. When inserting the hose, ensure it does not snag on the olive.

Insert the hose up to the witness mark on the outer hose casing.

Cover with a clean rag while conducting this procedure as some of the internal oil may leak.

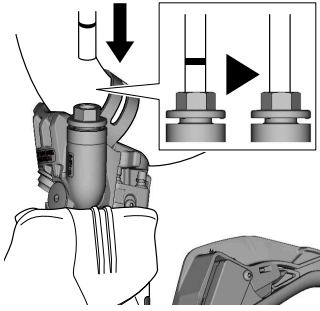

**5. Tighten the flare nut with flange.**

Tighten the flare nut with flange while pushing the brake hose in.

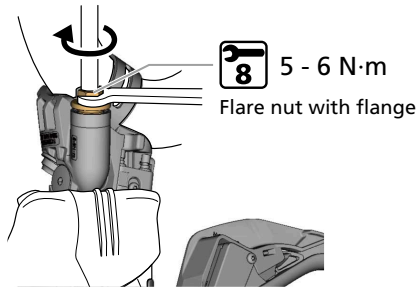

**NOTICE**

- Make sure to fully insert the brake hose and tighten the flare nut. Otherwise, oil leaks or insufficient braking force may occur.

**6. Wipe away any excess oil.**

**7. Check that the pad spacer is installed in the caliper.**

**8. Operate the brake lever several times. Check that the pads grip the pad spacer and that the lever becomes stiff.**

If the lever does not become stiff, refer to “ [Adding mineral oil and bleeding air](#) ” and bleed the air from the system.

# Installing the brake hose

Refer to the [Gravel Hydraulic Disc Brake/Dual Control Lever Dealer's Manual](#) to install the brake hose to the sub brake lever.

## Connecting the hose

**1. Cut the brake hose and install the connector insert.**

Refer to “ [Cutting the hose](#) ” in “Installing the brake hose (easy hose joint system).”

**2. Pass the brake hose through the flare nut and olive as shown in the figure.**

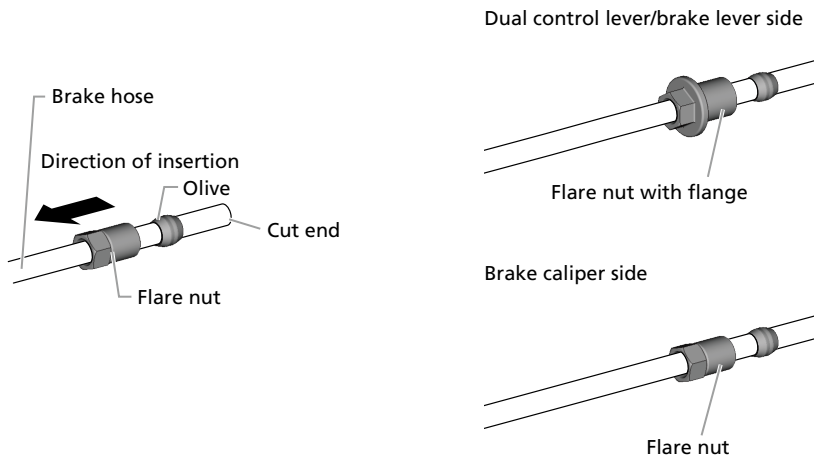

### **NOTICE**

- Use a flare nut with flange on the dual control lever/brake lever side.

**3. Check that the olive is in the position shown in the figure, then apply SHIMANO Premium Grease to the threads of the flare nut and outer surface of the olive.**

Dual control lever/brake lever side

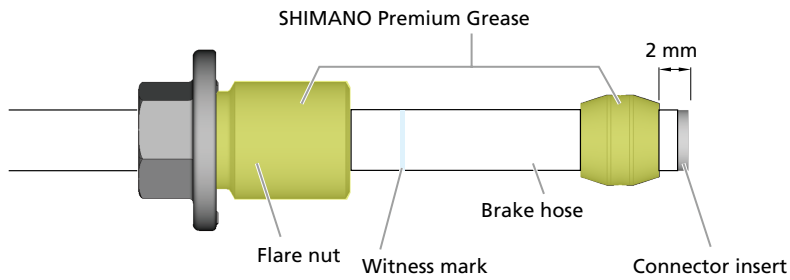

Brake caliper side

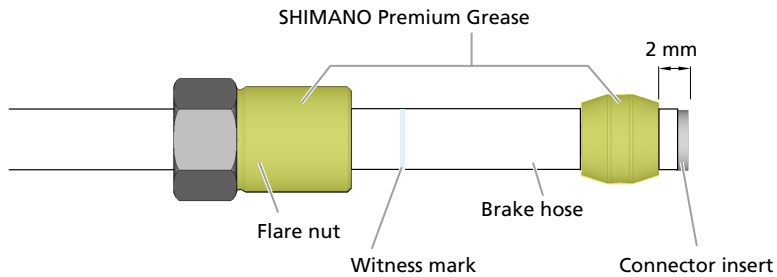

**⚠ WARNING**

- Use the dedicated connector insert supplied with SM-BH90-JK-SS. Use of any connector insert other than the one supplied may produce a loose assembly, which may prevent the brakes from operating and result in serious injury due to a fall or collision.

Model number: SM-BH90-JK-SSR

Length: 11.2 mm

Color: Silver

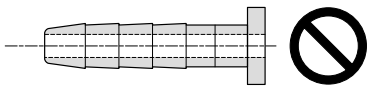
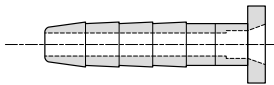

**4. Insert the brake hose.**

Insert the hose up to the witness mark on the outer hose casing.  
Make sure that the brake hose is not twisted.

Right-hand lever

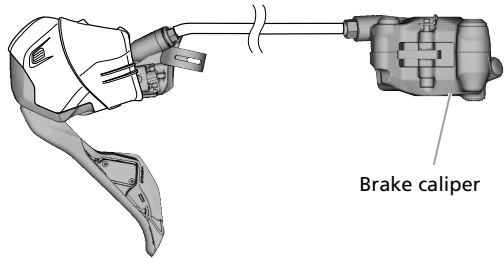

Left-hand lever

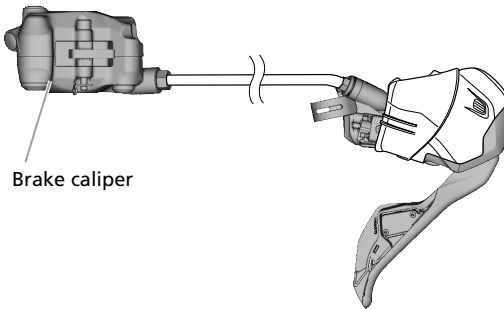

**5. Secure the brake hose.**

- (1) Secure the dual control lever/brake lever to the handlebar.
- (2) Tighten the flare nut with flange to the lever while pushing the brake hose.
- (3) Tighten the flare nut to the caliper while pushing the brake hose.

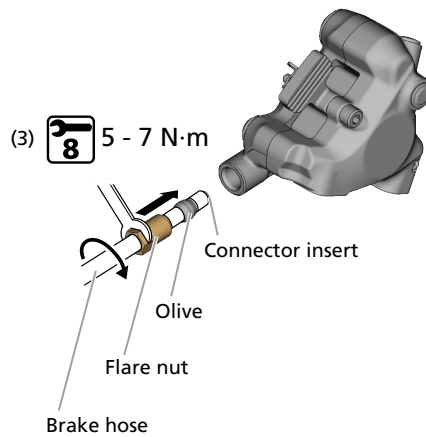
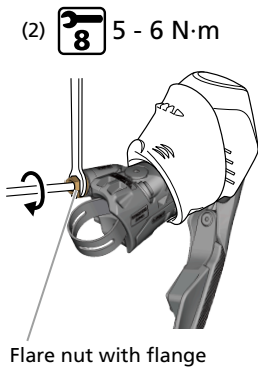

**NOTICE**

- Make sure the brake hose is straight when pushing.
- You may need to adjust the angle of the lever outward in order to gain clearance for the spanner. Be careful not to damage the handlebar and other parts when doing so.

**6. Temporarily secure the brake hose to the handlebar (by using tape or a similar material).**

Installation / removal  
Installing the brake hose

---

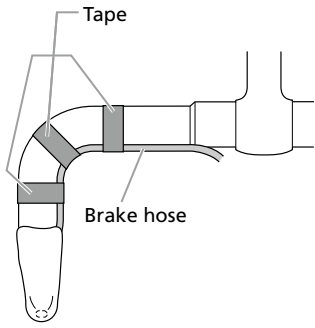

# Installing the brake calipers

Refer to the [Gravel Hydraulic Disc Brake/Dual Control Lever Dealer's Manual](#) to install the brake caliper.

# Adjustment

## Adjusting the reach

**1. Turn the reach adjustment screw to adjust the reach.**

Tightening the reach adjustment screw (clockwise) widens the distance between the position of the brake lever and the handlebar, while loosening the screw (counterclockwise) narrows it.

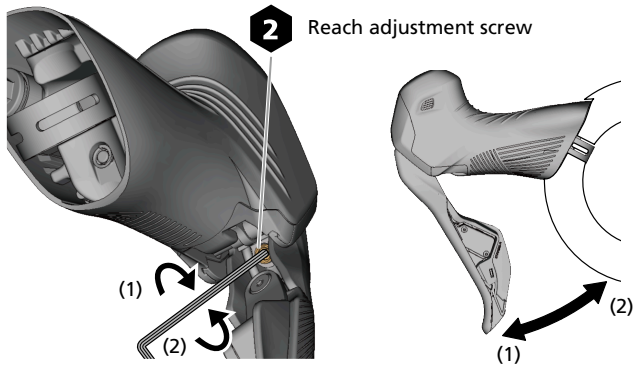

# Adjusting the free stroke

Adjust the range of travel of the brake lever until the pad and rotor come into contact. The free stroke adjustment moves only the initial position of the brake lever. If you want to move the pad engagement point relative to the handlebar, you must also perform a reach adjustment.

**1. Turn over the bracket cover from the front side.**

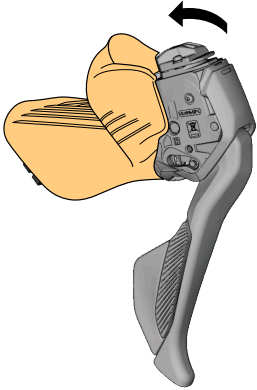

**2. Turn the free stroke adjustment screw to adjust the stroke.**

Tightening the free stroke adjustment screw (clockwise) narrows the range of travel of the brake lever, while loosening the screw (counterclockwise) widens it.

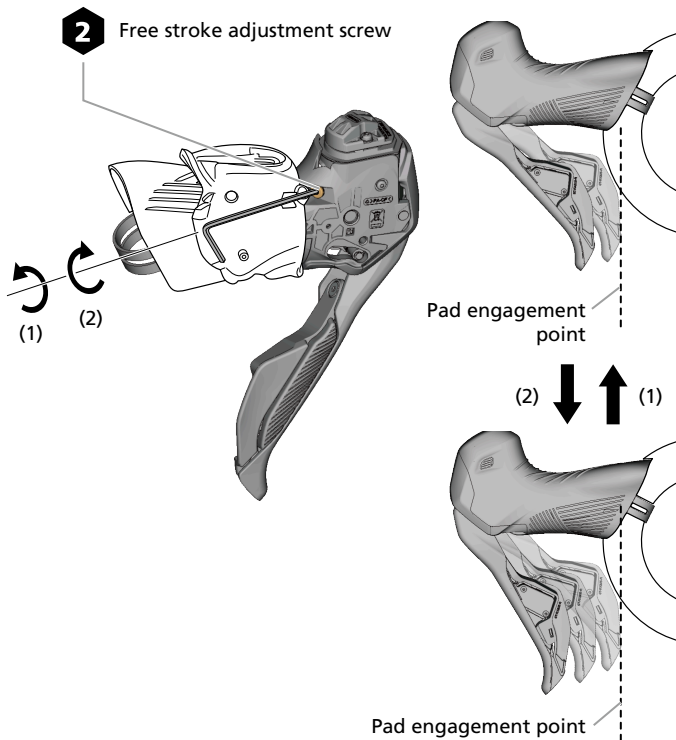

## NOTICE

- Stop loosening the free stroke adjustment screw when the free stroke stops increasing. Loosening the free stroke adjustment screw excessively may cause the screw to fall out of the bracket body. Do not forcibly tighten the free stroke adjustment screw. Otherwise, the adjustment screw may be damaged.

Adjustment  
Adjusting the free stroke

---

- Do not remove the washer from the free stroke adjustment screw.
- Position the free stroke adjustment screw so that it does not interfere with the bracket cover.

# Maintenance

## Replacing the pads

Refer to the [Gravel Hydraulic Disc Brake/Dual Control Lever Dealer's Manual](#) to replace the pads.

# SHIMANO genuine mineral oil replacement

It is recommended to change the oil when it becomes noticeably discolored.

## Draining the mineral oil

### **⚠ CAUTION**

- Note the following cautions when handling SHIMANO genuine mineral oil:
  - Do not drink. May cause vomiting or diarrhea.
  - Keep out of reach of children.
  - Do not cut, let near heat, weld or pressurize the SHIMANO genuine mineral oil container. Doing so may cause an explosion or fire.
  - Disposal of used oil: Follow local county and/or state codes for disposal.
  - Directions: Keep the container sealed to prevent foreign objects and moisture from getting inside, and store it in a cool, dark area away from direct sunlight or heat. Keep from heat or flame.
  - For cleaning brake hoses exposed to mineral oil, or cleaning and maintaining tools, use isopropyl alcohol or a dry cloth. Do not use commercially available brake cleaners. Doing so may cause damage to plastic parts.

1. **Secure the bicycle so that it is parallel to the ground using a stand, etc.**

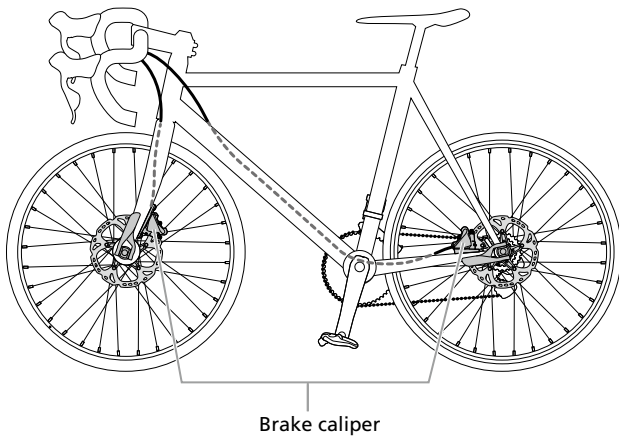

2. **Remove the pads from the calipers, and install the bleed spacer.**  
Refer to the [Gravel Hydraulic Disc Brake/Dual Control Lever Dealer's Manual](#).
3. **Turn over the bracket cover from the back side.**

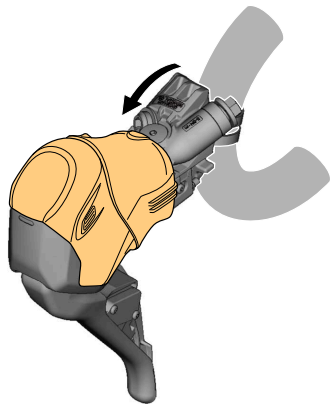

4. Set the lever in a position where the top surface of the bleed screw is parallel with the ground.

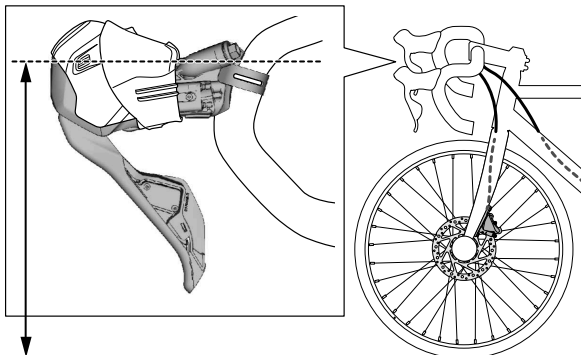

### **NOTICE**

- When adjusting the angle of the brake lever, be careful not to strain the brake hose or electric wire to avoid damage.

5. Remove the bleed screw and O-ring.

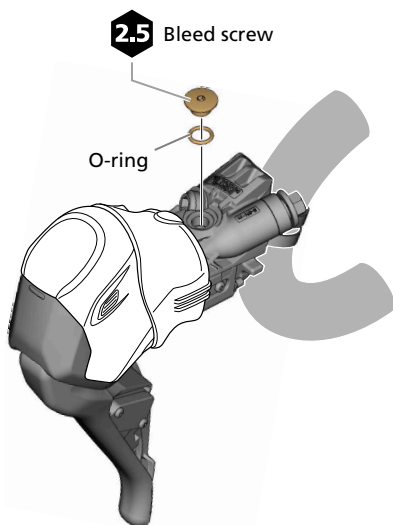

6. Install a bag and tube on the bleed boss.

- (1) Remove the bleed boss cap and bleed screw cap.
- (2) After attaching a bag to the tube, connect the tube to the bleed boss.

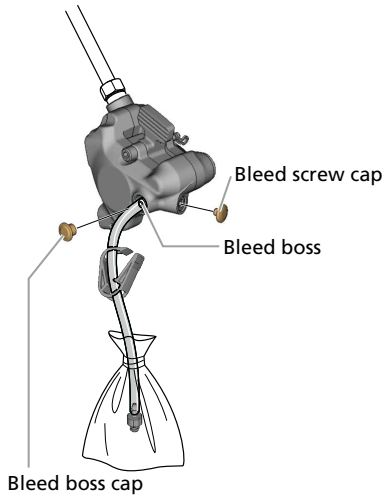

**7. Loosen the bleed screw.**

The oil will begin to drain. Operating the brake lever while the oil drains will allow the oil to drain more quickly.

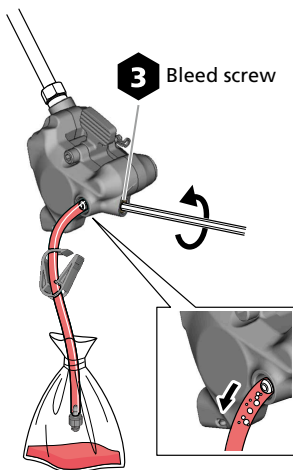

## Adding mineral oil and bleeding air

When adding oil, use only SHIMANO genuine mineral oil.

When using the sub brake lever, refer to the [Gravel Hydraulic Disc Brake/Dual Control Lever Dealer's Manual](#) to also bleed the air of the sub brake lever.

**1. Secure the bicycle so that it is parallel to the ground using a stand, etc.**

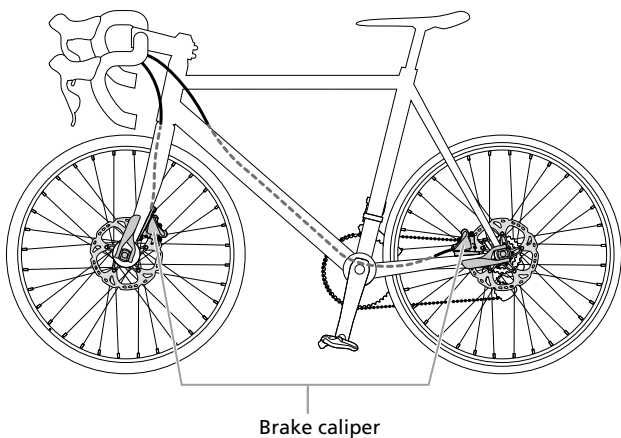

## NOTICE

- When bleeding air you will need the TL-BR001 and TL-BR002 SHIMANO original bleed tools.

**2. Remove the pads from the calipers, and install the bleed spacer.**

Refer to the [Gravel Hydraulic Disc Brake/Dual Control Lever Dealer's Manual](#).

**3. Turn over the bracket cover from the back side.**

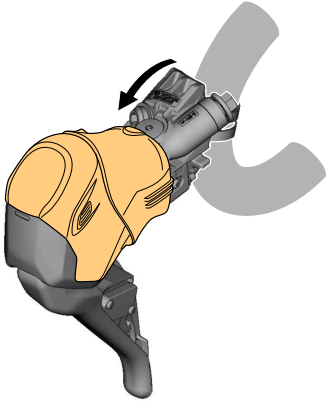

**4. Set the lever in a position where the top surface of the bleed screw is parallel with the ground.**

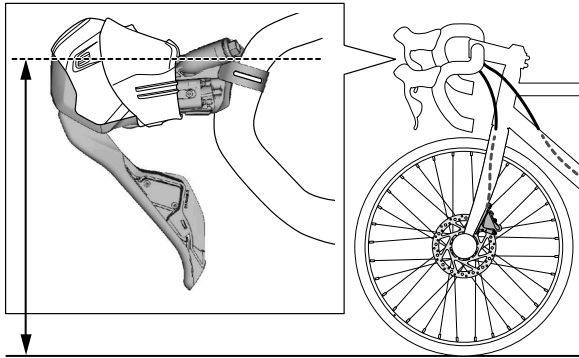

## NOTICE

- When adjusting the angle of the brake lever, be careful not to strain the brake hose or electric wire to avoid damage.

**5. Remove the bleed screw and O-ring.**

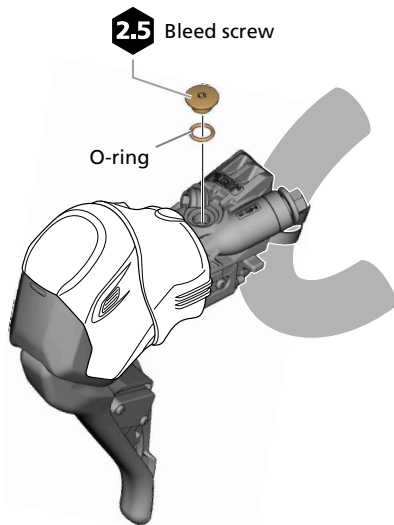

## **NOTICE**

- Be careful not to drop the bleed screw or O-ring.

### **6. Mount the oil funnel.**

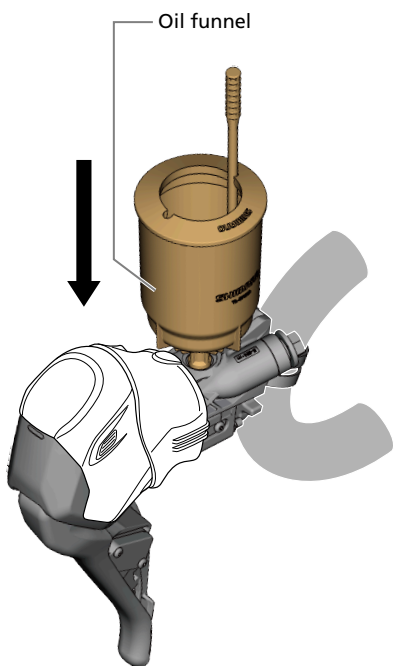

### **7. Add the oil through the bleed boss.**

Do not depress the brake lever while adding oil. Doing so may introduce air bubbles into the system. If the lever was depressed, drain the oil and re-start the process.

- (1) Remove the bleed boss cap and bleed screw cap.
- (2) Fill a syringe with oil, then connect the tube to the bleed boss.
- (3) Loosen the bleed screw by 1/2 of a turn.
- (4) Push the piston of the syringe to add the oil.
- (5) Oil will start to come out from the oil funnel. Continue adding the oil until there are no more air

bubbles in the oil that is coming out.

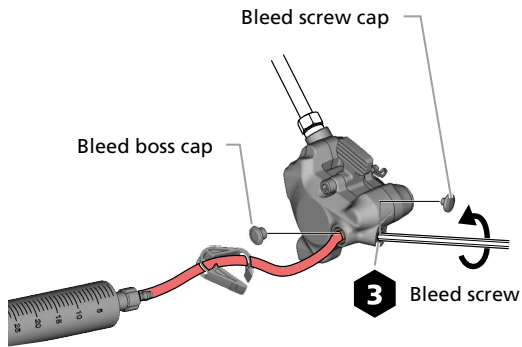

8. Temporarily close the bleed screw.
9. Operate the lever about 10 times.
10. Set the lever in a position where the top surface of the oil funnel is 20° to the ground, as shown in the figure.

Perform adjustment by changing the angle of the handlebar, etc.

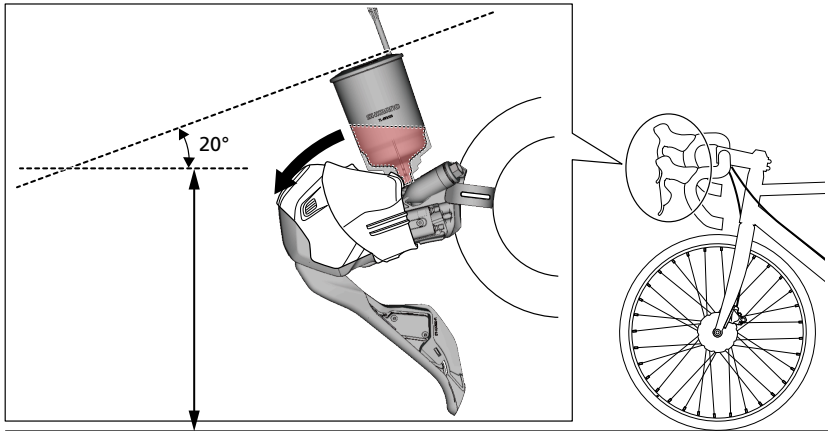

### **⚠ WARNING**

- Make sure to set the lever to the specified position before bleeding air. If you bleed air without setting the lever to the specified position, air bubbles may remain in the brake system. Air bubbles remaining in the brake system may prevent the brakes from operating and result in serious injury due to a fall or collision.

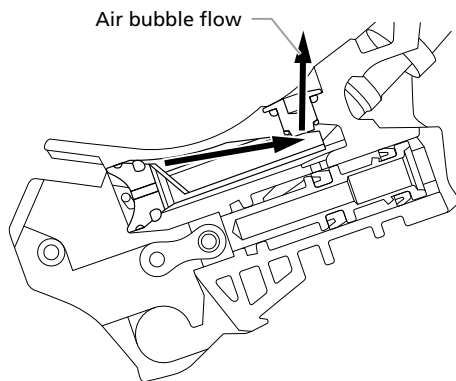

11. Operate the lever.

Air bubbles in the system rise up through the port into the oil funnel. Slowly repeat until no more air bubbles appear.

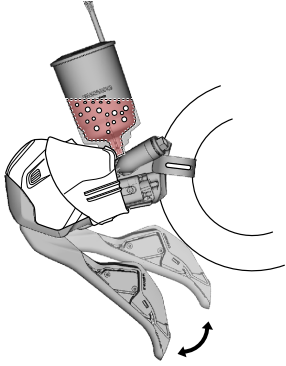

**12. Add the oil through the bleed boss.**

- (1) Loosen the bleed screw by 1/2 of a turn.
- (2) Push the piston of the syringe to add the oil.
- (3) Continue adding oil until there are no more air bubbles in the oil that is coming out.

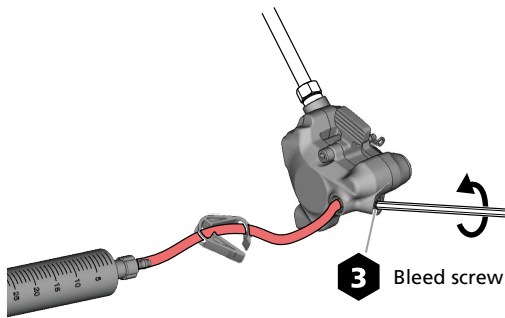

**13. Temporarily close the bleed screw.**

**14. Depress the brake lever a few times and make sure that the lever becomes stiff.**

If the lever does not become stiff, repeat the procedures from step [12](#).

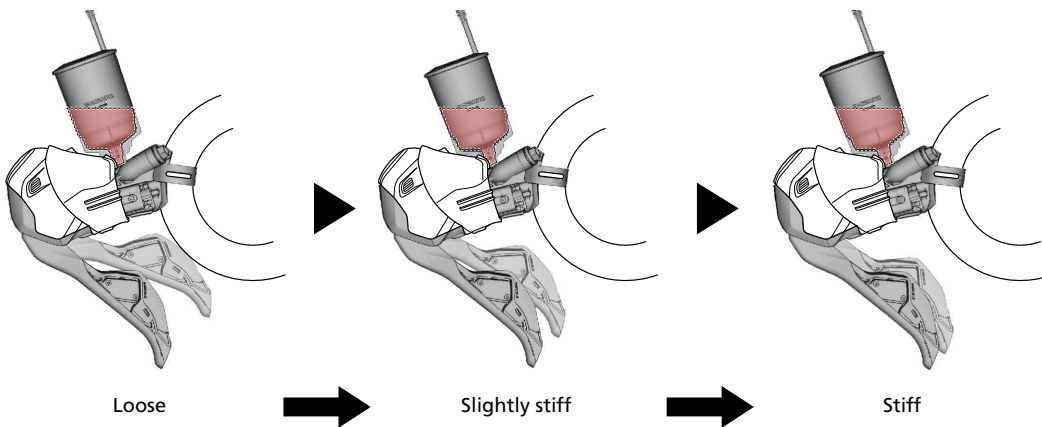

**15. Set the lever in a position where the top surface of the oil funnel is parallel to the ground.**

Perform adjustment by changing the angle of the handlebar, etc.

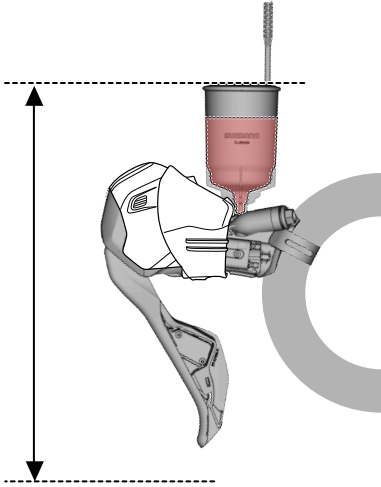

**16. Remove the syringe.**

Cover the end of the syringe tube with a clean rag to prevent spilling any oil.

**17. Bleed the remaining air.**

Most of the air bubbles remaining inside the brake system can be bled by performing the following operation:

- (1) After attaching a bag to the tube, connect the tube to the bleed boss.
- (2) Loosen the bleed screw.
- (3) After a little while, the oil and air bubbles will flow naturally from the bleed boss into the tube.

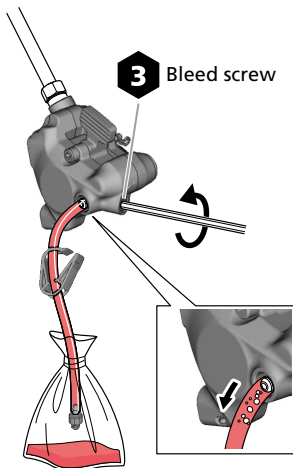

**TECH TIPS**

- It may be effective to shake the brake hose gently, to tap the lever bracket or caliper gently with a non-marring screwdriver handle, or to move the position of the calipers.

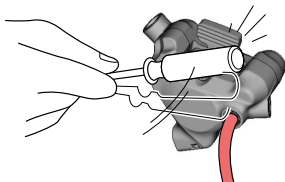

**18. As the oil level drops in the oil funnel, add oil to maintain the oil level and prevent air from getting into the system.**

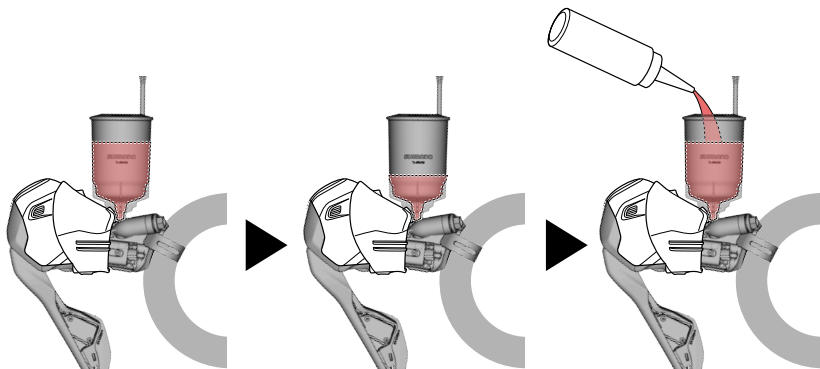

19. Once no more air bubbles come out from the bleed boss, tighten the bleed screw.

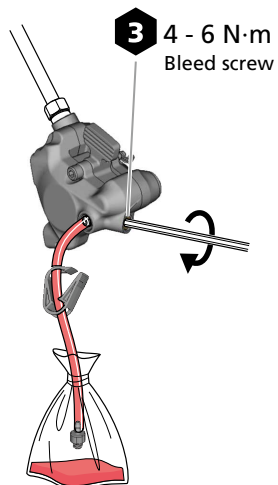

20. Remove the tube and wipe clean the oil remaining in the bleed boss.

Cover the end of the syringe tube with a clean rag to prevent spilling any oil.

21. Install the bleed boss cap.

22. Plug the oil funnel with the oil stopper.

Make sure that the side of the oil stopper with the O-ring attached is facing downward.

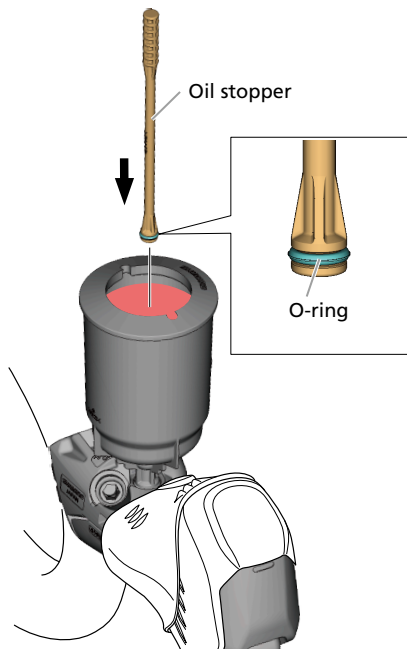

23. Remove the oil funnel with the oil stopper still in place.

Cover the bleed port with a clean rag when removing the funnel to absorb any excess oil that may drip out.

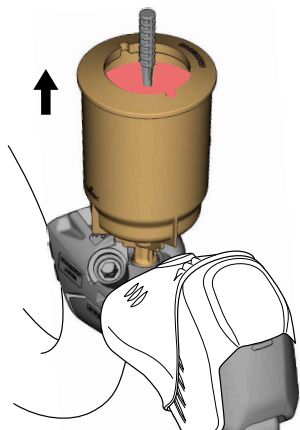

**24. Install a bleed screw with O-ring.**

Ensure the reservoir tank is full enough that oil flows out when tightening the bleed screw.

Do not operate the lever until the bleed screw is installed. If operated, there is a risk of air bubbles entering the cylinder.

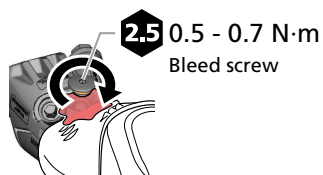

**25. Wipe away any oil that has overflowed.**

Use isopropyl alcohol to clean any oil that has overflowed.



# Caliper piston maintenance

Refer to the [Gravel Hydraulic Disc Brake/Dual Control Lever Dealer's Manual](#) to adjust the pistons.

# Replacing the bracket cover

1. **Remove the brake hose and electric wire from the dual control lever/brake lever.**  
Be careful so that oil does not spill from the dual control lever/brake lever or removed brake hose.
2. **Remove the dual control lever/brake lever from the handlebar.**
3. **Remove the bracket cover.**

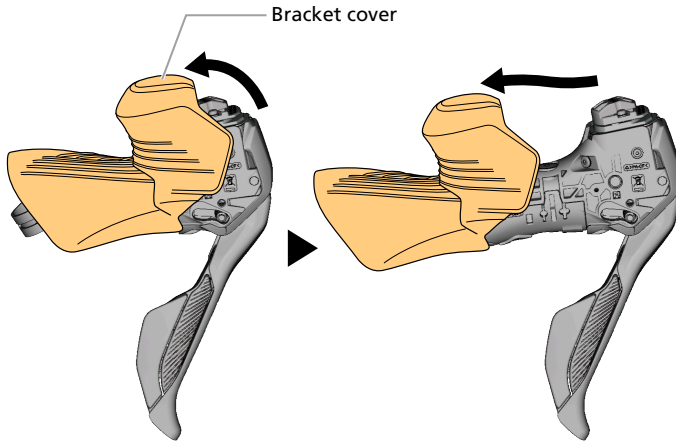

4. **Install a new bracket cover.**

Insert the protrusions on the bracket cover into the recesses in the bracket body when fitting on the bracket cover.

The inside of the bracket cover has a marking indicating the left side or right side.

## TECH TIPS

- It is easier to perform installation if isopropyl alcohol is applied to the inside of the bracket cover.

5. **Install the dual control lever/brake lever in its original position.**

- (1) Install the dual control lever/brake lever to the handlebar.
- (2) Install the electric wire and brake hose to the dual control lever/brake lever.

## NOTICE

- A new olive and connector insert are required to reinstall the brake hose.
- Make sure to perform the procedure in "[Adding mineral oil and bleeding air.](#)"

# Replacing the coin batteries of the dual control levers





## Before replacing the coin batteries

- The coin batteries supplied with the dual control levers may be low, as they are intended only for test purposes. When the coin battery level becomes low, replace the coin batteries with new ones.
- When replacing the coin batteries or opening/closing the battery holder, move to an area well away from sources of water (such as rivers, lakes, the ocean, or ditches).
- Do not perform this task in locations with a lot of water or mud, such as outdoors during rain or car washing facilities. If not observed, problems with operation may occur.
- Do not perform this task in areas with a lot of sand or dust in the air. If not observed, problems with operation may occur.
- Before replacing the coin batteries, wipe the battery holder and battery case to remove water, dirt, etc. If not observed, problems with operation may occur.
- Use your hands or an insulated tool with a blunt tip to replace the coin batteries.
- Take care of the terminals when removing the coin batteries in order to prevent damage to the coin batteries.
- When performing this task with your hands, clean your hands and remove all water and dirt before performing this task.
- Static electricity can damage electronic components. Discharge static electricity from your body before performing this task.
- Use two CR1632 coin batteries for each of the left and right dual control levers.
- It is recommended that you use new coin batteries.

## Checking the dual control lever battery level

If you hold down two shift switches simultaneously for 0.5 seconds or longer, the LED changes to any of the status shown in the figure depending on the battery level.

11% - 100%		Green
1% - 10%		Red
0%		Off

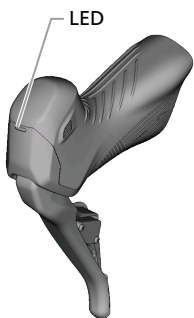

## Replacing the coin batteries

1. Turn over the bracket cover from the front side.

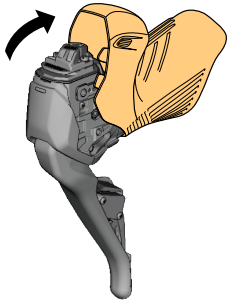

2. Open the battery holder using a screwdriver, and remove the two old coin batteries.

If it is difficult to remove a coin battery, affix tape, etc. to the surface of the coin battery and pull it out.

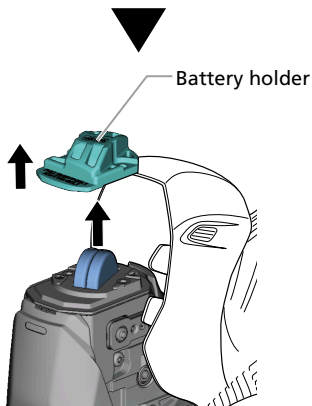
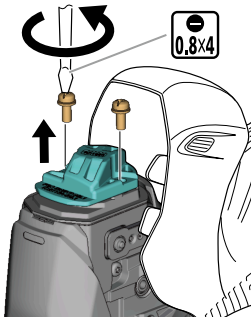

3. Set the new coin batteries to the battery case.

As shown in the figure, set the two coin batteries with the positive (+) side on the side of the + mark.

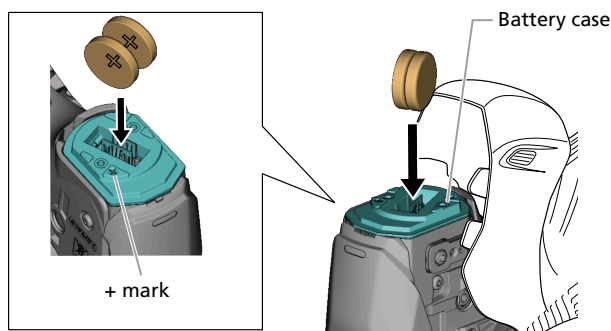

4. Close the battery holder, and firmly secure it with a screwdriver.

Firmly secure both screws.

Be careful not to overtighten the screw, as it may cause damage.

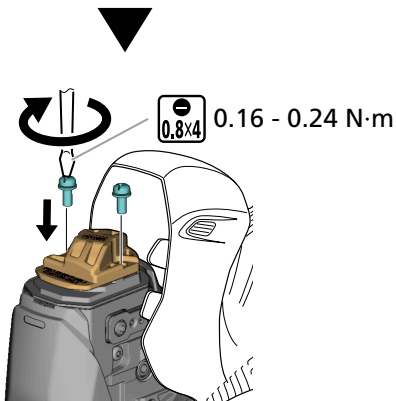
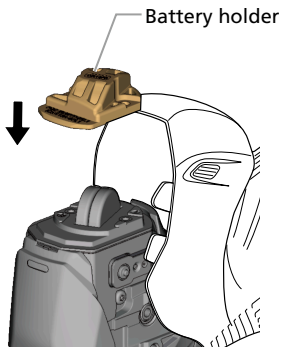

## NOTICE

- Before closing the battery holder, check that the waterproof sealing gasket and contacting surfaces are free of foreign substances (such as dirt, dust, sand, hair, thread, or liquids).
- If there are foreign substances present, wipe them away with a clean, dry, and lint-free cloth.
- Open the battery holder only when replacing the coin batteries, and do not leave it open. Doing so may cause problems with operation due to foreign objects getting inside or deterioration to the electronic component, etc.
- Make sure the coin batteries are installed correctly. Installing a coin battery with the positive (+) and negative (-) polarities reversed will not only stop the component from operating, it may also cause the component to malfunction.
- After replacement, check that it works normally.

# SHIMANO

**SHIMANO NORTH AMERICA BICYCLE, INC.**  
One Holland, Irvine, California 92618, U.S.A. Phone: +1-949-951-5003

**SHIMANO EUROPE B.V.**  
High Tech Campus 92, 5656 AG Eindhoven, The Netherlands Phone: +31-402-612222  
Only EU General Contact : [contactshimano@shimano-eu.com](mailto:contactshimano@shimano-eu.com)

**SHIMANO INC.**  
3-77 Oimatsu-cho, Sakai-ku, Sakai City, Osaka 590-8577, Japan

Please note: specifications are subject to change for improvement without notice. (English)  
© Apr. 2025 by SHIMANO INC. ITP